

## CONTENTS

**VOL. 48 ISSUE 11 NOVEMBER 1990**

**ON SALE OCTOBER 25**

**DECEMBER ISSUE ON SALE  
NOVEMBER 22**

# Short Wave Magazine

**Cover** The scanners on the front cover of *What Scanner* magazine were loaned by Nevada. *What Scanner* magazine is included free with this issue of *Short Wave Magazine* and will keep you up-to-date with the world of scanners.

Liniplex Loop Antenna	10	Mike Richards <b>G4WNC</b>
Amateur Radio Satellites		
Part 2	12	Arthur C. Gee <b>G2UK</b>
Solar SWLing	18	Greg Baker
HF Radio Wave Propagation - 3	20	F.C. Judd <b>G2BCX</b>
A Medium Wave AM Radio	26	R.G. Evans <b>G4XAT</b>
SWM Review		
Code 3 Data Decoding Software	31	Mike Richards <b>G4WNC</b>
DX Letter From America	40	Gerry L. Dexter

### What Scanner - Your Free Pull-out Magazine

#### REGULARS

A Word in Edgeways	2	Your Letters
What's New	4	Latest News & Products
Grassroots	6	Club News
Trading Post	7	Readers' Adverts
PCB Service	11	PCBs for SWM Projects
News Extra	15	More news
Subscriptions	19	Save Money
Scanning	23	For the Scanning Enthusiast
Book Case	25	Book Reviews
Airband	29	Aeronautical Radio News
Services	30	Important Information
RADIOLINE	34	News & Info Hotline
Gift Subscriptions	37	Give a Sub for Christmas
Starting Out	38	For the Beginner
Advertisers' Index	60	Find that Advert
Book Service	62	Order Your Technical Books

#### SEEN & HEARD

Amateur Bands Round-up	43	Paul Essery <b>GW3KFE</b>
Decode	44	Mike Richards <b>G4WNC</b>
Info in Orbit	47	Lawrence Harris
Band II DX	48	Ron Ham
Television	51	Ron Ham
Long Medium & Short	54	Brian Oddy <b>G3FEX</b>
LW Maritime Radio Beacons	61	Brian Oddy <b>G3FEX</b>

## GOOD LISTENING

EDITOR: Dick Ganderton, C. Eng., MIEE, G8VFN  
 ART EDITOR: Steve Hunt  
 NEWS & FEATURES: Elaine Richards G4LFM  
 TECHNICAL ARTIST/  
 PHOTOGRAPHER: Rob Mackie

#### EDITORIAL

Enefco House, The Quay,  
 Poole, Dorset BH15 1PP.  
 TEL: (0202) 678558  
 FAX: (0202) 666244  
 Prestel MBX 202671191

#### ADVERTISEMENT DEPARTMENT

ADVERTISEMENT MANAGER  
 Roger Hall G4TNT  
 TEL: 071-731 6222  
 FAX: 071-384 1031

#### ADVERTISEMENT PRODUCTION (Poole)

Marcia Brogan  
 TEL: (0202) 676033  
 FAX: (0202) 666244

#### © PW PUBLISHING LTD. 1990.

Copyright in all drawings, photographs and articles published in *Short Wave Magazine* is fully protected and reproduction or imitation in whole or in part is expressly forbidden. All reasonable precautions are taken by *Short Wave Magazine* to ensure that the advice and data given to our readers is reliable. We cannot however guarantee it and we cannot accept legal responsibility for it. Prices are those current as we go to press.

# A WORD IN EDGEWAYS

**IF YOU HAVE ANY POINTS OF VIEW THAT YOU WANT TO AIR PLEASE WRITE TO THE EDITOR. IF YOUR LETTER IS USED YOU WILL RECEIVE A £5 VOUCHER TO SPEND ON ANY SWM SERVICE.**

The Editor reserves the right to shorten any letters for publication but will try not to alter their sense. Letters must be original and not have been submitted to other magazines. The views expressed in letters published in this magazine are not necessarily those of Short Wave Magazine.

**Dear Sir**

The article 'Portable Power' by Ron Ham made very interesting reading to me. My father was one of the early wireless enthusiasts in the 1920s. He was caretaker and engine tester at a large cutlery works powered by two large gas engines, one of which produced power mainly to provide lighting.

Being d.c. it was a simple matter to rig up a charger for wireless accumulators, a very useful side line for him. I remember that our own radio had high tension supplied from small wet cells in two large carriers. All were housed in a cupboard in the bottom of the set. What a pong when the cupboard door was opened and

we found an acid burn in the carpet underneath.

In the first year of the 1939 war, some electrical shops 'broke-up' high tension batteries and after wrapping the individual cells in plain coloured paper sold them to us as torch batteries.

Does anyone remember the accumulators for the early so-called 'portable wireless'? These were a celluloid case and the acid was jellified, to avoid spillage. I saw my first portable wireless when I was ten and could only just lift it off the floor. Now we carry them in our pockets. Progress creates memories.

**PETER F. MILTON  
SHEFFIELD**

**Dear Sir**

Possible you are surprised to receive a letter from the West Ukraine but it's a fact.

I'm a young, 17-years old DXer. I have many DX-friends in different states and Simon Tyler-Murphy from East Sussex is among them.

Some time ago he sent me four numbers of your magazine (Feb-May) and only one thing I want to say: "Pity that we DXers haven't such like this in the USSR". There are many things not available. All is very simple - when you have (imagine!) £4000 you go to the shop and buy an IC-9000, but if all I have is 4000 rubles, I can't do this...

So I use only Soviet portable analogue VEF-214 with limited short wave from 25MHz to 48MHz, m.w., l.w. and east f.m.

For my mind, the best articles in s.w.l. are 'Seen & Heard', 'What's New' and 'Bandscan'. There are many in which I understand nothing, like 'Airband', 'Scanning', etc., because I never saw such radios.

Besides s.w., I'm very interested in f.m. DX. This summer I logged f.m. stations from Bulgaria, Georgia, Moldavia, Gorkiy-City, Turkmenia, Hungary, Syria and even Spain. I listened to them with SINPO 55555 on 'east' standard f.m. receiver. But no-one can tell me why it happened. Maybe you can help me in this question.

Sergey listed some of the m.w. DX he has recently received. Unfortunately there isn't space to print all of it, but I have included a few here. I have purposely left Sergey's letter as received - I only wish that I could write as well in any foreign language. ED

531kHz - Leipzig - DDR - 100kW - at night

621kHz - Bata - Egypt - 2000kW - at night

738kHz - Barcelona R.1 - Spain - 500kW - at night

981kHz - Megara - Greece - 200kW - at night

With only best wishes from the Ukraine

**SERGEY S. OLEYNIK  
UKRAINE**

**Dear Sir**

I have from England the August copy of Short Wave Magazine, and read with interest your article on the Yacht Boy 220. My first reaction when reading this article was 'what took you so long?' Grundig have really improved and they are the only portable short wave manufacturers, to my knowledge, to include a digital alarm clock in their compact design s.w./f.m. radios. The Yacht Boy 220 does not have a clock but the range 13m through to 75m is remarkable for the price. Have you seen the Yacht Boy 215? That's worth a mention in your magazine too I think.

More evidence, perhaps, that the Japanese may be losing the market?

**R LAWRENCE, PARIS**

**Dear Sir**

With reference to previous correspondence by listeners regarding the use of c.w., especially Mr Millmore's letter of June.

To improve my c.w. I have during the last year listened to various coastal radio stations throughout the world on various frequency bands. I have sent several reports and received letters and QSL cards in return, in one case a very nice glossy brochure describing the station's history.

One publication that lists these transmissions is the well-known Klingenfuss Guide to Utility Stations expensive but very good.

According to a letter received from VCS, Halifax, NS, Canada, providing the station sends a CQ call listeners are within the law to listen to the transmission.

Yes, c.w. is alive and well at least at the moment.

**J. J. PARRY G4AKX  
NORTHWICH**

**Dear Sir**

I am an s.w.l. and on September 6 I heard an appeal by YU2HDE in Yugoslavia on 14MHz for medical supplies for a hospital. His call was answered by quite a few G and other European stations. One G station in particular got in touch with a company in London, who in turn supplied him with a telephone number in Belgrade, who hopefully would be able to supply the drugs to the hospital.

My point is that this action could have saved the lives of those people in the hospital in Yugoslavia. This epitomises the true spirit of radio amateurs everywhere. I hope the operator, GOJZT, does not mind me mentioning his callsign, but I believe he deserves a special thank-you not only from me as an s.w.l., but from radio amateurs everywhere.

**H WOOD, MANCHESTER**

**Dear Sir**

I have been short wave listening seriously for about two years now. Before that I just twiddled the knobs on the short wave bands on my family's Grundig Satellit 2000 in the kitchen.

I must recommended this set to any serious listener. Although not sold anymore if you can purchase the set - get it. The set covers: l.w. - 150-400kHz, m.w. - 510-1600kHz, s.w. - 1.6-30MHz continuous, f.m. - 89-108MHz.

The set can tune c.w., a.m., f.m. and with an adapter, s.s.b. Without a doubt it is an excellent receiver with built-in speaker and a 1.2m tall telescopic antenna and with an adapter and equipment for the car, tape the signal. However, the disadvantage this set has is its size. But it is an excellent base receiver, but saying this you can with a special lead operate the set off a 12V d.c. car battery or 240V a.c. mains and you can add a ground, external antenna to the set for better results. Conclusion - a very good user-friendly set.

My final point - please, please could you devote some of your brilliant magazine to youngsters and novices. I am 13 and I know no-one who is interested in radio full stop so I cannot swap notes. You could have a column on what times are best to listen and to what band, advice, penalties, facts, sets and projects (designs, etc.) and somewhere you could exchange views and opinions and notes.

**MARK FARR  
CREWE**

Mark has put forward an interesting idea, one to which I have been giving some thought for a while now. We are planning several important changes to SWM in the new year to provide you with an even better and more interesting magazine and this could just be one of them. ED

# A WORD IN EDGEWAYS

Dear Sir

I feel I must put pen to paper after reading the comments in 'Word in Edgeways' concerning the RAE.

I have been interested in amateur radio since the age of 14 (I am now 22) and have a varied range of listening equipment which I greatly enjoy using, but I would dearly love to hold an RAE certificate!

I therefore disagree with Mr M Chodron's comments. I don't think Mr Hill would like it 'gift wrapped on a plate' at all and nor would I. I have sat the exam, twice! I have finally come to the conclusion that the questions set in the paper on operating practice are an absolute waste of time. Why on earth you have to know all that rubbish amazes me. How many times have you heard somebody quote Ohm's Law or resonance, conductivity and the like in a conversation? All I hear is callign, location, antenna, name and equipment details mentioned.

Why can you not just prove how to set up a station without causing interference, make contact correctly and fill out a log? I can hear some people saying "well anyone would have a licence then", - not with the price of radios they wouldn't. Because that's basically all you do anyway. OK, fair enough if you are talented enough to build your own set then that's fine - but not for me. As someone who is not that talented and who finds it hard to take in all the theory I fear I shall never be able to afford to keep re-sitting the exam to speak to all the voices I hear.

It seems a shame that someone who can buy a rig, install it, fit the correct coaxial cable to an antenna and correctly s.w.r. it is not allowed to transmit.

**M. COOK  
SOMERSET**

Dear Sir

I refer to the RTTY decode program in the August issue, written by Ian Wraith.

After many hours of trying, I am afraid I have failed to modify it to suit my Spectrum+. I wonder if you have any feedback from any reader who has succeeded in converting the program? I have found the frequencies for the WX information (I think).

I have been reading you magazine now since January 1988 and I find it to be a great help and a mine of information. I have the RTTY, c.w., FAX, SSTV and two or three programs obtained from yourselves and would like to see more programs such as the WX program offered in your magazine.

Those of us who have a very limited amount of cash available cannot move into the 'Big Boys' League' of PCWs, etc., and appreciate we have our limits.

Thank you for your efforts and hope to see a solution in the near future in SWM.

**HAROLD PINKNEY, ANGLESEY**

Dear Sir

The article on battery operated radios of years ago by Ron Ham in SWM interested me greatly, so I felt I must add my contribution on the subject.

During the years 1948-1953 I was working for a small, privately-owned, radio business. My duties largely consisted of driving a small van around the area collecting the 2 volt accumulators for re-charging and leaving the freshly charged ones. The cost of this per charge was 6d. In fact there was a time when we reduced the charge to 4d in an effort to capture more customers from a rival firm. Some customers used 6 volt car batteries, and they had spring clips fitted to the l.t. leads of their radios to enable them to use just one of the three cells at a time, they were therefore getting a lot for their money. Then we started collecting radios for conversion to 'auto-bias' so that the 9 volt grid-bias battery was no longer required. Later on again, by around 1950-51, as the mains electricity

reached the surrounding villages, we converted quite a lot of radios to a.c. mains. Most were possible to convert, and the cost was around £8, whereas a completely new radio was around £20 at the time and could be more depending on what was required.

Further to the collection and delivery of the re-chargeable accumulators, there is one other event which I will always remember. One Christmas a local farmer gave me a chicken for Christmas. I was so excited to have been given this that I rushed homeward to present it to my new wife. On reversing the old wooden bodied van down the rather dark cul-de-sac where we lived at the time, I reversed into a gas lamp post, severely damaging the van and smashing a number of customers' accumulators! I had to make all this good, so it was not such a happy Christmas after all.

**PATRICK CONNOR  
TROWBRIDGE**

Dear Sir

It was a great pleasure for me to see in the latest issue of SWM my good friend Ron Pearce's article on constructing a one-valve s.w. receiver. I have a great admiration for Ron's enterprise in making and operating such sets which seems to me to be in the true spirit of amateur radio. Anyone can buy a 'black box' about which they know nothing but what appears in the maker's blurb it takes a real enthusiast to build for himself!

You may be interested to learn that a colleague of my wife has only recently begun to be interested in s.w. listening. On an impulse he entered a newsagents to see if there was a magazine that might deal with the subject and was fortunate enough to find, straightaway, the issue mentioned above. Result, one delighted new reader for SWM and a convert to the pleasures of construction!

I enclose under separate cover, details of a small mains power supply unit which I designed for use with simple receivers such as Ron's, using relatively low-voltage components and eminently suitable for constructors unfamiliar with mains-powered equipment.

**CHAS MILLER  
WOODSEAVES**

It seems that the constructional projects which we have featured in SWM have proved to be very popular. The R-210 conversion was extremely popular and the matching converter has also created a lot of favourable comment. Ron Pearce's One-valve Receiver was brought to you as a result of many requests from interested readers. Watch out for Chas Miller's power supply some time in the New Year. ED

Dear Sir

I have a problem!

In recent years I made several attempts at an RAE correspondence course. Each time my attempts have foundered in a sea of boredom.

The trouble is that I cannot see the relevance of Ohm's Law, and the colour code of resistors, to driving my 'Yaesicom Multiknob'. I am totally in favour of a test of ability as an operator, to prove that one will not interfere with ones neighbours Neighbours. I suspect that the present system is a relic of radio experimental days, with a touch of 'I had it to do, so you must', (Howls of rage and coals of fire).

I would suggest that a certificate of competence to operate, with an additional licence for those wishing to use home-brew apparatus. Which I am sure most people would aspire to with experience.

I did get my Morse up to 18 w.p.m. so I am not a total dilettante. Perhaps if I attended the local classes I would battle through the basics better.

I am sure I am not alone.  
**JOHN D MORLEY, MORECAMBE**

I must admit that I have tried to learn Morse but until someone can come up with a way of preventing the first few dits and dahs literally sending me to sleep then I am afraid that I will remain a fourth-class citizen - a 'lowly' Class B. I also find that very few days go by without me finding a use for Ohm's Law and similar calculations. ED.

# WHAT'S NEW

## Dynamic Duo

Two new low cost analogue multimeters now available from Alpha Electronics are useful for a host of general purpose applications. Both measure a.c. and d.c. voltage, direct current, resistance, dB and have a diode and battery test function. Pivot and jewel screw mechanism with a mirror scale are features of the analogue displays which have both fuse and diode input protection.

Model AM1001 is the smaller of the two measuring just 100 x 65 x 32mm and weighing 110g. Both a.c. and d.c. voltage can be measured to 500V and direct current to 250mA. The d.c. sensitivity is 10k $\Omega$ /V with a.c. at 4k $\Omega$ /V.

Model AM2001 measures to 1000V on both a.c. and d.c. plus direct current to 10A. The d.c. sensitivity is 20k $\Omega$ /V and a.c. is 8k $\Omega$ /V. Another feature of the instrument is a continuity test with audible alarm. Both models are fully guaranteed for 12 months and supplied ready for use with test leads, battery, spare fuse and instruction manual. The AM1001 costs £9.94 and the AM2001 costs £19.95 (both excluding VAT).

## RIG

*Newsletter 21* from the Remote Imaging Group has recently arrived on my desk. It is some 68 pages packed with all kinds of information for the satellite watcher. Another surprise was the number of different authors writing in the issue.

The kind of topics covered are the PC-GOES reviewed, the Russian Satellite Scene, RIG Membership Survey, Maplin Receiver Mods, Beginners Guide Part 1, just to mention a few. If you would like details on RIG, contact: **Des Watson G3YXO, Norton, Gote Lane, Ringmer, Nr Lewes, East Sussex BN8 5HX.**



**Alpha Electronics Ltd., Unit 5, Linstock Trading Estate, Wigan Road, Atherton, Manchester M29 0QA.**

## The Gower Award

The Swansea Radio Amateur Constructors Club will be holding a special event station on or around the Gower Coast, South Wales every four weeks on Sundays. There are 12 sites split into four groups on both h.f. and v.h.f.

Group 1 - Beaches: Mumbles Head (Jan 6), Port Eynon (May 26) and Oxwich Bay (Dec 9).

Group 2 - Castles: Pennard Castle (Nov 11), Weobley Castle (Mar 3) and Penrice Castle (July 21).

Group 3 - Historical: Cefn Bryn (Oct 14), Hardings Down (Mar 31) and Paviland Caves (Aug 18).

Group 4 - Places of Interest: Hangmans Cross (June 23), Penmaen (Apr 28) and Fairwood Common (Feb 3).

The times to look for the events are between 1000 and 1700, subject to changes. The frequencies are: h.f. 7.070, 14.270, 21.270 & 28.4-28.6MHz; and v.h.f. 144.320 & 145.400MHz.

For a list of events and how to claim the Gower Award, send an s.a.e. to **GW0JKB, QTHR.**

## Safety First

A PowerBreaker safety r.c.d. adaptor is a device that provides added protection against the risk of electrocution. Unlike a fuse or circuit breaker, a residual current device protects the user by automatically cutting the power before you get a serious shock.

PowerBreaker are available not only as handy adaptors, but also as protected 13A plugs and single or twin wall sockets.

The PowerBreaker safety adaptor is a compact r.c.d. which simply plugs in, requiring no additional wiring. This makes it ideal when using things like soldering irons, etc. The PowerBreaker is readily available from high street stores such as Woolworth, Boots, Argos, Texas, B&Q and Payless with prices starting from around £20.00.

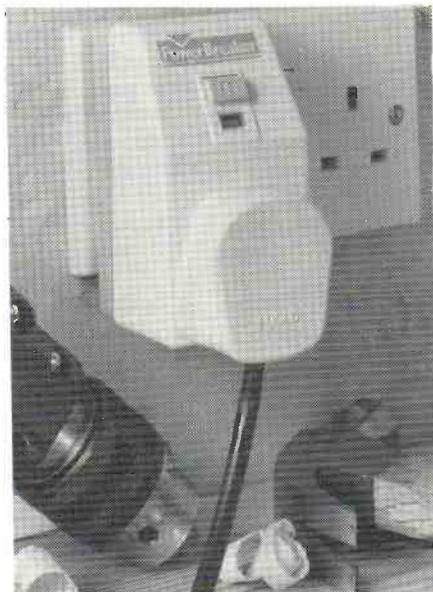

## New US Magazine

A new quarterly magazine for the radio amateur is being launched around mid-November. It is designed to fill the technical niche left when *Ham Radiomagazine* ceased publication in June 1990. The new quarterly is devoted to presenting state-of-the-art material in the fields of amateur radio and electronics. Issue release dates are currently scheduled for November, February, May and August.

Each issue of *Communications Quarterly* will have about 100 pages of technical material. It will be printed on high-quality paper and perfect bound (square-backed). A four-issue subscription will cost \$39.95 for overseas readers.

**Communications Quarterly, Main Street, Greenville, New Hampshire 03048, USA.**

## BARTG News

BARTG, the British Amateur Radio Teledata Group, have announced that Ann Reynolds G6ZTF has taken on the task of BARTG's Membership Secretary as of early September. The address is: **Miss A Reynolds G6ZTF, 169 Bell Green Road, Coventry CV6 7GW.**

The AGM will be held on November 10 at 2pm. The venue is The Churchill Room at London House, Mecklenburgh Square, London. Topics for discussion are the subs for 91, plans for the 1991 Rally and the election of a new Committee. Refreshments will be provided.

## Radio Link

Radio Link, Derby Hospital Broadcasting will be providing additional services over two weekends in November.

From November 15 to 18, a number of members will be operating an amateur radio special event station from the Outside Broadcast Caravan at the Derby City Hospital, Utttoxeter Road, Derby. They hope to contact other amateurs within a 95km radius of Derby and pass on reports, also information regarding hospital radio in the Derby area. GB1RLD will be using v.h.f. (144MHz band) from:

Thursday November 15 between 1900 and 2030

Friday November 16 between 1900 and 2030

Saturday November 17 between 1000 and 1600

Sunday November 18 between 1000 and 1500

On Saturday November 3, Radio Link will be presenting an outside broadcast during the day from Copecastle Square, Eagle Centre, Derby.

**John Huddleston, Secretary/Press Officer, 8 Wilmot Avenue, Chaddesden, Derby DE2 6PL.**

# WHAT'S NEW

## Engineering Information

NICAM digital stereo should be available on Border Television and Channel 4 in parts of Cumbria and Dumfries and Galloway. It's part of an IBA initiative to bring the new digital audio technology to almost 80% of British viewers by the end of this year.

As we have explained before, NICAM stands for Near-Instantaneously Companded Audio Multiplex. It adds a special digital signal to a standard TV transmission to enable reception of stereo sound with quality similar to compact disc. The system can also be used to provide a second language soundtrack.

In order to receive NICAM, it is necessary to have a TV set of video cassette recorder incorporating a NICAM decoder.

The Radio 1 FM and Radio 4 FM services from Meldrum and Forfar should have started during September. Engineering test transmissions, using normal Radio 1 and Radio 4 programmes, are expected to have started during September. These go out a week or two before these new f.m. services officially opened.

The frequencies used are:

	Meldrum	Forfar
Radio 1 FM	98.3MHz	97.9MHz
Radio 4 FM	95.3MHz	94.9MHz

Both stations already transmit Radios 2, 3 and Scotland on f.m.

To obtain good f.m. reception on a portable radio, the in-built telescopic antenna should be fully extended and adjusted to find the angle which gives best results.

Another area starting Radio 1 FM reception in September is that served by the Winter Hill transmitter. Using a frequency of 98.2MHz, this new BBC service will bring clearer reception of Radio 1 FM, in stereo, to around 90 000 people in central Lancashire.

The BBC is building two new f.m. radio stations in Wiltshire to improve reception in the Chippenham and Salisbury areas. The following frequencies will be used:

	Chippenham	Salisbury
Radio 1	98.4MHz	99.4MHz
Radio 2	88.8MHz	89.8MHz
Radio 3	91.0MHz	92.0MHz
Radio 4	93.2MHz	94.2MHz

The Radio 1 FM service from the BBC's Guildford transmitting station should have been on the air since late September. Radio 1 listeners in Guildford and western Surrey should now be tuned to 97.7MHz.

## Dunkirk Veterans

As a result of organising and running the two 50 years commemorative stations GB50DNK and GB50SUN for the whole of May, A. Milham G3OPL has received a considerable number of letters from Dunkirk veterans.

He has now produced a ten-page information brochure incorporating these letters which readers can obtain for £1.50 to cover the cost of photostats, postage and packing from **A. Milham (Buster) G3OPL, QTHR.**

## Programme News

**HCJB Saturday's DX Partyline.** Nov 3 - Ken MacHarg joins DXPL with an interview with Costa Rica's 'Radio for Peace International'. The programme also feature Neil Carleton's look at radio stamps.

Nov 10 - Part II of Ken MacHarg's visit to 'Radio for Peace International' will be featured along with the ODXA perspectives.

Nov 17 - Reports from SPEEDX, A Pacific DX report, and a profile of the country of Angola will be featured.

Nov 24 - DXPL has reports from ANARC, SPARC and EXDC.

Dec 1 - Neil Carleton's radio stamps will again be featured on DXPL.

Dec 8 - The country of choice for this edition will be Kenya. Along with that comes ODXA perspectives.

Dec 15 - DXPL visits Costa Rica's 'Radio Rumba' in Cartago and includes the Pacific DX report and the SPEEDX report.

Dec 22 - HCJB will be the focus as they near their 59th anniversary - that's on Dec 25. Also featured will be reports from ANARC, SPARC and EDXC.

Dec 29 - DXPL looks back at short wave broadcasting in 1990 and the changes that have arrived on the scene.

## Spectrum Decoding

Using the new system from Technical Software and a standard Epson-compatible dot matrix printer, you could produce full resolution charts, press photos and weather satellite pictures on any 48K or 128K Spectrum computer.

Weather charts, press photos and re-broadcast satellite pictures are all correctly reproduced with intermediate grey shades for the pictures. There are separate greyscales for each of the three standard signal shifts to give the very best results. Fully automatic reception of all signals for unattended operation. All the standard settings of 60, 90, 120, 240r.p.m. and 288, 352, 576IOC are supported. Inverted scanning (essential for press photos) and picture reverse options and on-screen tuning indicator that really works (no streaky lines which leave you wondering just where the correct tuning position is).

The package displays signals from the geostationary Meteosat and polar-orbiting NOAA satellites with full grey shading. Fully automatic reception of Meteosat signals for unattended operation. Signal-derived synchronisation eliminates Doppler skew and allows the use of tape recorded signals. A v.o.g.a.d. signal amplifier removes the need for black and white level controls and enables any convenient audio source to be used without special adjustment. Brightness and contrast controls lets you set the display for the best picture.

The system uses a specially designed interface adapter board to allow the Spectrum to communicate fully with the outside world and to supply the hardware timing which the Spectrum lacks. The software is easy to use and can be supplied either on tape or Spectrum +3 disk, but may be copied to other formats if required. The SIA-2 interface adapter board and tape software costs £40.00 whilst with the +3 disk it costs £42.00. To receive FAX, the Spectrum FAX interface is £40.00 and for weather satellites, the APT-1 weather satellite decoding module is £59.00.

**Technical Software, Fron, Upper Llandwrog, Caernarfon, Gwynedd LL54 7RF. Tel: (0286) 881886.**

## Measuring Current

The DCP1 is a digital clip-on ammeter available from The Instrument Centre at Newport. The meter measures alternating current on a clear 3 1/2 digit liquid crystal display. Data Hold is provided for retaining the measured value under awkward operating conditions.

Alternating current is measured from 0 to 400A to a basic accuracy of 1.5%. Designed for ease of use, this battery operated, hand-held unit has a wrist strap for additional safety. Rugged and reliable, with 'drop-proof' construction, the DCP1 has a jaw capacity of 28mm, is overload protected and supplied ready for use by TIC with a one year guarantee. Options include a carrying case.

The units costs £29.00 excluding VAT and is available from: **TIC Ltd., 53 Fairfax Road, Newport, Gwent NP9 0HR.**

## Type Approval

Industry Minister Douglas Hogg today appointed the British Approvals Board for Telecommunications (BABT) as a body responsible for type approval of telecommunications terminal equipment.

BABT will now be the main type approval body for general telecommunications equipment (for example telephones, answering machines and modems). This new function will complement BABT's current status as primary evaluating body, with responsibility for arranging type approval testing for telecommunications apparatus.

BABT took over the evaluation work, previously undertaken by British Telecom, to bring the UK into line with European Commission developments intended to separate apparatus approval from network provision.

The Appointment will be linked to a Fees Order (SI 1990 No. 1679) under the Telecommunications Act 1984. BABT will only be empowered to approve apparatus covered by the Order. Fees for approvals procedures remain unchanged from current BABT charges.

# GRASSROOTS

Lorna Mower

**Basingstoke ARC:** 1st Mondays, 7.30pm. The Forest Ring Community Centre, Sycamore Way, Winklebury. Andy Wynn G1JTO. Tel: (0256) 64756

**Bromley & DARS:** 3rd Tuesdays, 7.30pm. The Victory Social Club, Kechill Gardens, Hayes. Nov 20 - Junk Sale. Geoffrey Milne, 081-462 2689.

**Bromsgrove ARS:** 2nd & 4th Tuesdays, 8pm. Aston Fields Working Mens Club, Stoke Road, Astonfields, Bromsgrove. Nov 13 - Baluns by Dave Edwards G4ZWR. J. Yarnall G1JLQ. Tel: (0527) 503024.

**Chelmsford ARS:** 1st Tuesdays, 7.30pm. Marconi College, Arbour Lane, Chelmsford. Roy Martyr, Chelmsford 353221 ext 3815.

**Cheshunt & DARC:** Wednesdays, 8pm. Church Room, Church Lane, Wormley. Oct 31 - Junk Sale, Nov 7 - Natter Nite, 14th - Orchids from the World by Frank G0KUQ, 21st - AGM. Roger Frisby, Hoddesdon 464795.

**Coventry ARS:** Fridays, 8pm. Baden Powell House, 121 St Nicholas St, Radford, Coventry. Oct 26 - Night on the Air, Nov 2 - Bangers 'n' Mash Supper, 9th - Night on the Air, 16th - trip to be confirmed. Neil, Coventry 523629.

**Delyn RC:** Alternate Tuesdays, 8pm. Daniel Owen Centre, Mold. Nov 6 - Packet Radio User Group Demo by G8MMM & Co, 20th - Talk by the local Fire Prevention Officer. Steve Studdart, Deeside 819618.

**Derby & DARS:** Wednesdays, 7.30pm. 119 Green Lane, Derby. Oct 31 - Halloween Cheese & Wine Party (bring your own home-brew for testing!), Nov 7 - Junk Sale, 14th - Visit by SMC of Chesterfield. Kevin Jones, Derby 669157.

**Dunstable Downs RC:** Alternate Fridays. Nov 2 - Junk Sale, 16th - Components and their Characteristics Talk. Mike Spacey, QTHR.

**Hastings E&RC:** 3rd Wednesdays, 7.30pm. Westhill Community Centre, Croft Road, Hastings. Nov - Demo of Vintage Military Wartime Radio.

**Keighley ARS:** Thursdays, 8pm. Ingrow Cricket Club, near Hainworth Village, Keighley. Oct 25 - Natter Night, Nov 1 - Junk Sale, 8th - Night on the Air G0KRS, 15th - Films, 22 - Natter Night. Kathy, Bradford 496222.

**Lothian RS:** 2nd & 4th Wednesdays, 7.30pm. The Orwell Lodge Hotel, Polwarth Terrace, Edinburgh. Nov 14 - Junk Sale, 28th - Underground Radar by John McDonald. P.J. Dick GM4DTH, QTHR.

**Midlands AX-25 Packet Radio Users Group:** 1st Mondays, 8pm. The Community Centre, Perton, Nr Wolverhampton. Greg Lewin G0NEN. Tel: (0785) 840186.

**Mid-Warwickshire ARS:** 2nd & 4th Tuesdays, 8pm. St John Ambulance HQ, 61 Emscote Road, Warwick. Nov 13 - Programme Discussion for 1991 led by Chairman. Mike Newell, Kenilworth 513073.

**Norfolk ARC:** Wednesdays, 7.30pm. The Norfolk Dumpling, The Livestock Market, Harford, Norfolk. Oct 27 - Outing to the Leicester Show, 321st - Debate: "Who needs contests in Amateur Radio", Nov 7 - 'Real Radio' Evening, 14th - Surplus Equipment Auction doors open 7pm, 21st - An Introduction to Power Supplies by Mike Lemin G4UUB. Mike Cooke, (0362) 850591.

**Salop ARS:** 2nd & 4th Thursdays. The Bucks Head, Frankwell, Shrewsbury. Oct 25 - Resonance by John Roberts GW3RBM, Nov 8 - Equipment Sale, 22nd - An Introduction to the Novice Licence by Derek Pearson of Jandek Kits. J.R.M. Bumford, G0GTN.

**Shefford & DARS:** Thursdays, 8pm. Church Hall, Ampthill Rd, Shefford. Nov 1 - The New OSCARS by Richard G3RWL

AMSAT-UK. Nigel Leaney, Royston 71149.

**South Bristol ARC:** Wednesdays. Whitchurch Folkhouse Assoc, Bridge Farm House, East Dundry Rd, Whitchurch. Nov 7 - 28MHz Activity Evening, 14th - Simple Computer Programming by G4RZY, 21st - Free Ice Cream Evening by Muriel G4YZR. Len Baker, Whitchurch 832222.

**South East Kent (YMCA) ARC:** Wednesdays, 8pm. The YMCA, Leyburne Road, Dover. Oct 31 - Icom (UK) Presentation, Nov 7 - Natter Night, 14th - Inter-Club Quiz (provisional), 21st - Natter Night.

**Stevenage & DARS:** Tuesdays, 7pm. Ground Floor Lecture Room, D Block Ridgemoor Training Enterprise, Ridgemoor Park. Oct 29 - RAE Course, Nov 5, 12 & 19 - RAE Course, 6th - GB3HN Repeater by Jeff G0HOP, 13th - Practical Sausage Balloons by Ralph, 20th - Fish Flashing (Sonar Radar) by Peter G0GTE. Peter G0GTE. Tel: (0438) 724991.

**Stoke-on-Trent ARS:** Thursdays, 7.30pm. Sacred Heart RC Church Hall, Jasper Street, Hanley, Stoke-on-Trent. D. Wroe G0MXD. Tel: (0782) 639476.

**Stourbridge & DARS:** 1st & 3rd Mondays. Robin Wood's Community Centre, Scotts Road, Stourbridge. Nov 5 - Natter Night, 19th - Winter Surplus Sale. Dennis Body G0HTJ, QTHR.

**Sutton & Cheam RS:** 3rd Thursdays, 7.30. Downs Lawn Tennis Club, Holland Ave, Cheam.

1st Mondays in the Downs Bar. Nov 15 - EMC & the Work of Kenley Laboratories by Dave G4AKY. John Puttock G0BWW, QTHR.

**Trowbridge & DARC:** 1st & 3rd Wednesdays, 8pm. Territorial Army Centre, Bythesea Road, Trowbridge. Nov 7 - Constructors Cup Evening Judging of Entries. G0GRI, (0380) 830383.

**Verulam ARC:** 2nd & 4th Tuesdays, 7.30pm. RAF Association HQ, New Kent Rd, St. Albans. Nov 27 - Packet Radio by Mr P Andrews. Andy Ince G0BZS, QTHR.

**West Kent ARS:** 3rd Fridays, 8pm. The School Annex, Albion Road, Tunbridge Wells, Kent. Nov 16 - Construction Competition 'The Fastest Construction Competition'.

**West of Scotland ARS:** Fridays, 7.30pm. The Martyrs' School, Townhead, Glasgow G4 0PX. John GM0KTO, QTHR.

**Wimbledon & DARS:** 2nd & last Fridays, 7.30pm. St Andrews Church Hall, Herbert Road, SW19. Oct 26 - AGM, Nov 9 - Meet the Committee. Nick Lawlor, 081-330 2703.

**Yeovil ARC:** Thursdays, 7.30pm & Fridays, 7.30pm. The Recreation Centre, Chilton Grove, Yeovil. Oct 25 - Natter Night, Nov 1 - Discussion Night, 8th - A Simple a.t.u. by G3MYM, 15th - HF Propagation this Winter by G3MYM, 22nd - Ideas for Club Events in 1991 by G3MYM. David Bailey G0NMM, QTHR.

**Club Secretaries:**  
Send all details of your club's  
up-and-coming events to:  
'Grassroots', Short Wave Magazine,  
Enefco House, The Quay,  
Poole, Dorset BH15 1PP

# TRADING POST

**FOR SALE:** RX4 RTTY/c.w./SSTV/AMTOR receive program, TIF1 interface and Commodore 64C computer, datacassette, joystick, etc. All as new, £125. J. Daniels. Tel: Milton Keynes 373373.

**FOR SALE:** AOR-900, thick leather case, boxed in mint condition £150. Sony AN-1 and Yaesu FRA-7700 active antennas £25 each various J&P c.w./RTTY interface to Amstrad computer. Offers. Les. Tel: (0257) 792451 evenings.

**FOR SALE:** Yaesu FRT-7700 a.t.u., mint, £30 plus postage. Datong FL3 multi-mode filter, mint, £70 plus postage. Tel: 061-494 9043.

**FOR SALE:** Eddystone 840C, general coverage receiver, 300kHz-30MHz and speaker. £75. J. du C Muller. Tel: Etwahl 4320.

**FOR SALE:** One PRO-31 hand-held scanner £95, also one Philips D2935 digital receiver £119, both in good condition. J.S. Wood, Rashcrook Cottage, Birnie, Elgin, Moray, Scotland IV30 3SW.

**FOR SALE:** Sony PRO80 portable RX, l.w., m.w., s.w., v.h.f., f.m., s.s.b., p.s.b., Air, mint £185. Also Superscope Professional treble head stereo cassette recorder, NiCads, miniature lapel mic plus hand-held mic, shoulder case, v.g.c., £175. Jim. Tel: (0245) 400760.

**FOR SALE:** 144MHz band transceiver, 25W, 5W, 144-146MHz, 16 memories, c.t.c.s.s., scanning, priority channel, repeater shift, listen on input, good condition. **WANTED:** Sony ICF-2001D RX. Keith Dickens. Tel: (0543) 360372.

**WANTED:** Partridge Joystick and tuner for s.w.l., cash waiting for good outfit. Tel: 091-526 7902.

**FOR SALE:** Realistic PRO-2002 scanner, boxed, hardly used, just three months old. Plus load coil antenna, frequency book and manual. List £235, accept first offer of £150. Vickery. Tel: 081-644 2508.

**FOR SALE:** Sony 7600D plus power supply and Waveguide, £80. Sony AN1 active antenna with attachments, £25. Instruction books with both items. Tel: (0939) 32714.

**EXCHANGE:** large quantity Futaba model aircraft gear, all as new, for Kenwood or Icom h.f. receiver or airband scanner. Davis. Tel: Gloucester 415056.

**FOR SALE:** Heathkit SW717G (550kHz to 30MHz) short wave receiver with b.f.o. for s.s.b./c.w. Recently serviced and factory aligned by Heathkit agents, complete with manual. Ideal for s.w.l. beginner, £38 including postage. S. Butler, 44 Navar Drive, Bangor, Co. Down, N. Ireland BT19 2SW.

**FOR SALE:** YES370M vehicle number plate, offers over £500. P. Yarley, 23 Abbotshall Road, Cults, Aberdeen. Tel: (0224) 868479.

**FOR SALE or EXCHANGE:** Yaesu FRG-8800, excellent condition. Looking for £400 or radio controlled plane and cash adjustment. Buyer collects. Tel: (0290) 24859 (Cumnock).

**FOR SALE or EXCHANGE:** KAM packet system. Looking for £200 or AR1000/Fairmate HP-100E scanner. Also direct conversion receiver 80/20m, £25; old (1960ish) amateur bands receiver, working, £25. Malcolm. Tel: Shrewsbury (0743) 67087.

**FOR SALE:** Kenwood R2000, ERA Microreader & Olivetti printer. All in first class condition, £635 the lot, or will split. Tel: Derby (0332) 47707.

**FOR SALE:** Yaesu FRG-9600 scanner (50-950MHz) with Dressler ARA900 active antenna and power supply. Still in original box and packaging, mint condition, used twice. Cost £700, want £495. Tel: (0992) 27539.

**FOR SALE:** Yaesu FRG-7700 receiver 150kHz-30MHz all-mode plus FRT-7700 tuner plus manuals, all in good condition. £275 o.n.o. Pat. Tel: Cardiff (0222) 709456 after 6pm.

**FOR SALE or EXCHANGE:** A CR150 valved communications receiver, 2-60MHz. Offers please. Paul Narrison. Peterborough (0733) 62848.

**FOR SALE:** Sony ICF PRO-80, unwanted competition prize, brand new and unused, £230 o.n.o. Tel: London 071-328 9885.

**FOR SALE:** Sony 7600D plus power supply and Waveguide, £80. Sony AN1 active antenna with attachments, £25. Instruction books with both items. Tel: (0939) 32714.

**FOR SALE:** Sony Air-7 with p.s.u., £130 or exchange for a communications receiver Grundig Satellit or similar, walkie-talkie answer phone or w.h.y.? Cash adjustment either way. G.F. Stewart, Swyn-Nant, Drefach, Llanybther, Dyfed SA40 9YB. Tel: (0570) 481076.

**WANTED:** memory unit for Yaesu 7700 receiver. P. Theobald. Tel: Swindon 611103.

**FOR SALE:** Trio R2000, £360; SEM v.h.f. converter, £30; Sony AN1 Active Antenna, £20; FT-77 8-band 100W f.m. board boxed £420; converted Hygain5 CB10M, £80. Buyer collects. Tel: Telford (0952) 617120.

**FOR SALE:** Realistic PRO-34, 200 channel hand-held scanner, 30-54, 108-174, 380-512 & 806-960MHz (some gaps). Good condition with manual and NiCads, £140. G.D. Bloomfield. Tel: Oxford (0865) 66075.

**FOR SALE:** Signal R535 v.h.f./u.h.f. airband receiver with mains unit, two antennas, instructions, as new, £210. Mark Barratt. Tel: Bristol 854521 after 7pm.

**FOR SALE:** Lowe HF-225 with a.m./f.m. detector and keypad, 8 months old, £400. Tel: 09052) 583388.

**FOR SALE:** Realistic PRO-2005 scanner 25-520MHz, a.m., f.m., w.b.f.m., 400 channels, 2 months old, as new & boxed, £240 including book. K. Waller, 20 Whitelands Road, High Wycombe, Bucks. Tel: (0494) 25733.

**EXCHANGE:** Canon T80 camera with AC35-70/75-200mm auto-focus zoom lenses for Realistic PRO-34 hand-held scanner. Camera cost over £400 and is in mint condition, no time wasters please. A. Mahon. Tel: 051-630 4337.

**FOR SALE:** NRD525 receiver 90kHz to 34MHz 6 months old immaculate, box, manual, £800. Yaesu FRG-9600MkV, scanning receiver 100kHz to 950MHz, manual, excellent condition, £400. Mr J. Jackson, 16 Harlech Close, Kenilworth, Warwickshire. Tel: (0926) 56764.

**FOR SALE:** Sony PRO-80 scanning receiver 150kHz-108MHz, 115-223MHz, a.m., f.m., s.s.b., fine tune, hardly used £175. Mr J. Jackson, 16 Harlech Close, Kenilworth, Warwickshire. Tel: (0926) 56764.

**FOR SALE:** Drake R7 receiver, very good condition, perfect working order, superior dynamic range, selectivity and sensitivity, £850. Drake crystal filters for R7 - 500Hz, 1.8kHz, 4kHz, 6kHz, £60 each. Drake Aux7 board for R7, £50. Keith. Tel: 081-570 5603.

**FOR SALE:** complete s.w.l. station; Yaesu FR-8800, fitted v.h.f. module. FRT-7700 a.t.u.; Sony active antenna; Revex discone; headphones. All as new, original cost excess £900, sell as package, £650 o.n.o. J. Clark. Tel: Crowborough (0892) 661970.

**FOR SALE:** SEM v.h.f. converter plugs into any h.f. receiver antenna socket, receives 118 to 146MHz. Cost £65 accept £40. Indoor/outdoor v.h.f./u.h.f.

scanner antenna 60MHz to 525MHz 43 x 1in, £20. Tel: Edge Hill 749 (Warks).

**FOR SALE:** Airband receiver R532, 100 memory channels, auto or manual scan, 118 to 139.975MHz, £140. Sharp MZ711 computer with built-in printer and tape little used, complete programs, games and books, bargain £50. Tel: Edge Hill 749 (Warks).

**FOR SALE:** Signal R-535 v.h.f./u.h.f. airband receiver, with mains supply, boxed, as new, £185 o.n.o. WIN108 v.h.f. airband receiver, boxed, as new, £130 o.n.o. Tel: (0509) 844166.

**FOR SALE:** Eddystone 770R (R213) v.h.f. RX, tuning 19MHz to 165MHz in six ranges, provision for c.w., a.m., n.b.m., w.b.f.m., plus manual, original condition, £150 no offers, buyer to collect. Mike Evans. Tel: 081-505 6303.

**WANTED:** Passport to World Band Radio, HF Antennas for all Locations, W1FBs Antenna Notebook, Practical Wireless magazines pre-1976. State price. Mike Evans. Tel: 081-505 6303.

**FOR SALE:** with mains adaptor, boxed as new, Realistic PRO34 hand-held v.h.f./u.h.f. scanner 68 to 512MHz 806 to 960MHz. Cost £249.95, want £150. Mr K Miller, 15 The Rise, Green Lane, Whitby, Yorks YO22 4ES.

**FOR SALE:** Philips 2999 communications receiver, as new in box, manual and 3 year warranty, direct frequency entry and b.f.o., twin speaker system. See June '89 SWM for review, £220. Free carriage. Tel: (0734) 811168.

**FOR SALE:** FT-690MkII 6m multi-mode, as new condition (boxed), hardly used, plus 15W Nevada amplifier £280. Tel: (0734) 696471 (Reading).

**FOR SALE:** Uniden Bearcat 200XLT hand-held scanner, excellent v.h.f./u.h.f. performance, coverage includes u.h.f. and airband, 200 memories. Set offered as new with supplied accessories. £180 o.n.o. Tel: 081-997 2491 after 6pm.

**FOR SALE:** ICS FAX1 complete system, one year old, v.g.c., £275. N. Richardson, Tel: Wendover (0296) 623037.

**FOR SALE:** ERA Mk2 Microreader, £60.00, will post. Tel: (0742) 312488.

**FOR SALE:** Realistic DX160 communications receiver 0-30MHz, Datong Notch Filter model ANF, Yaesu v.h.f. converter, FRV-7700 140-170MHz. Reasonable offer accepted. Tel: Ashdon 223 (Camps).

**FOR SALE:** ICS FAX1 including Navtex decoder, SC1200 printer and ANT 1 active antenna, all leads and manuals - as new £300.00. Tel: Dorking (0306) 711313.

**FOR SALE:** Yaesu FRG-9600 scanner 600905MHz, excellent condition, a.c. power supply, box, manual, etc. £275. J. Warner. Tel: South Humberside (00469) 31668.

**FOR SALE:** Racal RA17 very good condition, very powerful. This receiver is better than 17L - 117E, £175. Trio R-1000, good condition, sensitive, £195. Exchange possible. Tel: 081-571 5759 (Southall).

**FOR SALE:** Tandy PRO-2004 scanner, complete with antenna, manual and box. Sale only because going portable. As new, £200. Tel: (0259) 43334.

**SWM NOVEMBER 90 TP**

Write out your advertisement in BLOCK CAPITALS - up to a maximum of 30 words plus 12 words for your address - and send it, together with your payment of £2.30, to Trading Post, Short Wave Magazine, Enefco House, The Quay, Poole, Dorset BH15 1PP. You must send the flash from this page, or your subscription number as proof of purchase of the magazine. Advertisements from traders, apparent traders or for equipment which it is illegal to possess, use or which cannot be licensed in the UK will not be accepted.

# When you are ready to graduate to real listening Look to Lowe



## The NRD-525 from JRC

In America, they refer to the NRD-525 as JRC's superset, and it's not a bad description, because there is little doubt that the NRD-525 stands in a class of its own. Whatever you want a receiver to do, it's likely that the NRD-525 will do it; whatever you want to hear, the NRD-525 will allow you to listen to it.

What will the NRD-525 do for you? In a space so limited as this page, I cannot possibly cover all the answers, so I will let a respected reviewer make some comments for you. Here's what Rainer Lichte, author of "Radio Receivers — chance or choice" said about it:-

### Accuracy and stability

"The tuning accuracy and the matching display are impressive indeed. Still the more impressive is the receiver's frequency stability. Drift is virtually non-existent, it was measured at less than 5Hz/hour."

### And about dynamic range:-

"ICP 3rd order (3rd order intercept point) was measured at +17dBm at 7MHz and +14dBm at 25MHz. These are excellent values, and they are not the result of decreased sensitivity. The NRD-525 is amongst the most sensitive receivers I've measured so far. . . . Dynamic range was computed to 102dB, an equally outstanding value."

All very well you may say, but what does this technical jargon mean in real life? Let me quote Rainer Lichte again:-

"The signal quality under adverse conditions is remarkable, e.g. the 40 metre band here in Europe is fairly cluttered with high-power stations and most receivers just quit when you try to extract some intelligence from a weak radio amateur signal. The NRD-525 is unimpressed and functions in a truly professional manner."

In other words, there is virtually nothing you cannot resolve. If it cannot be received by the NRD-525, it cannot be received by

anything. As a final quote from the review, let me give some conclusions:-

"The receiver is a joy to operate and a joy to listen to."

"The new NRD-525 very impressively manifests itself as the No. 1 receiver outside the commercial/military bracket."

"Performance-wise, the NRD-525 is way ahead of the competition because this receiver delivers outstanding results in all modes of operation."

When you try an NRD-525 for yourself, all that Rainer Lichte has said will be clearly true, but that's not the end of the story, because the NRD-525 has a range of options which will extend its use even further; to VHF/UHF with an internally fitted converter; to more demanding applications with a range of high performance IF filters; to almost anything you want it to do.

For more advice on this outstanding receiver, just send for details, or call in here at Matlock, or at any of our branches across the country. You will find us helpful, knowledgeable and competent, and when you buy from us you have the comforting thought that you have the backing of Europe's best service team should you require it. That's why JRC, Kenwood, AOR, Signal, Daiwa, and all the other well known names have chosen us to be their sole UK distributors. Others may sell the radios, but we do so much more. Try us and see.

NRD-525	90kHz to 34MHz. . . . .	<b>£1095</b>
Options		
CMK-165	VHF/UHF converter. . . . .	<b>£391</b>
CMH-530	RTTY demodulator. . . . .	<b>£102</b>
CMH-532	RS232 interface. . . . .	<b>£91.75</b>

The NRD-525 is fitted with 12kHz, 6kHz and 2.4kHz filters as standard. Option filters are available for 300Hz, 500Hz, 1kHz and 1.8kHz bandwidths.

# FREE

Send four first class stamps to cover the postage and we will send you, by return of post, you FREE copy of "THE LISTENERS GUIDE" (2nd edition), a commonsense look at radio listening on the LF, MF and HF bands. Its unique style will, I am sure, result in a "good read" but underneath the humour lies a wealth of experience and expertise. You will also receive detailed leaflets on our range of receivers and a copy of our current price list.

## LOWE ELECTRONICS LIMITED

Chesterfield Road, Matlock, Derbyshire DE4 5LE Telephone 0629 580800 (4 lines) Fax 580020 Telex 377482



# 26 YEARS IN SHORTWAVE

## When it comes to scanners Look to Lowe

### AR-3000 – The Ultimate Receiver



It is an acknowledged fact that AOR are the foremost manufacturer of VHF/UHF monitoring receivers in the world. In the AR-3000, even AOR have excelled themselves, because they have produced what is without doubt the ultimate receiver for wide band monitoring use.

Designed for the professional market, the AR-3000 is nevertheless affordable by the listening enthusiast, and the specification is enough to make any keen listener want this astounding receiver. Brief details:—

Imagine a frequency coverage from 100kHz to 2036MHz; that's from below Radio 4 on the Long Wave to beyond satellites on 1.7GHz; and there are no gaps in the tuning range. Any frequency within this astounding range is yours to use as you wish.

Imagine all mode facilities, including AM, FM (communications), FM (broadcast), Upper Sideband, Lower Sideband, and even CW. Yours to command with the AR-3000.

Imagine tuning in 50Hz steps for accuracy on SSB/CW, with any step available at your choice from 50Hz to 100kHz, selectable in 50Hz increments. For really high speed tuning you can even increase all the steps by a factor of 10 by a touch of the main tuning knob.

Imagine 400 memory channels in 4 banks of 100, with each bank having its own priority channel, and each bank having its own programmable search system.

Imagine High speed scanning at 20 channels per second, with each memory channel having frequency, mode, and RF attenuator setting stored safely in it.

Imagine having a real time clock for accurate logging.

Imagine having a built in RS-232 computer interface for total control by a personal computer.

Imagine having all this with the outstanding performance which AOR built in to their famous AR-2002, but have now improved on for the AR-3000.

The AR-3000 is the monitor's dream receiver, and it is finally becoming available for general sale now that the Government orders have been fulfilled. Contact us right away for details of delivery schedules, and be prepared to own the best receiver anyone has yet produced.

AR-3000 — a dream come true.

**AR-3000.....£765 carr by Securicor £10**

For the past 26 years Lowe Electronics have specialised in seeking out the best in radio and bringing it to our customers. Those customers will also tell you that we have another speciality — looking after them. Whatever is best in radio, we sell. Whatever we sell, we back with really expert advice and service. We are pleased to represent the best companies in the receiver world, and in addition to the AOR range shown here, we also distribute receivers from Signal Communications and WIN, two of the top names in Airband radio. For full information and a copy of our Airband Guide, simply send us four first class stamps and mention that you saw our ad. in Short Wave Magazine". Happy listening.

Shops in **GLASGOW** Telephone 041-945 2626. **DARLINGTON** Telephone 0325 486121. **CAMBRIDGE** Telephone 0223 311230  
**BARRY** Telephone 0446 721304. **LONDON** Telephone 081-429 3256. **BOURNEMOUTH** Telephone 0202 577760  
All branches are closed all day Monday.

# Short Wave Magazine

£1.60

NOVEMBER 1990

**FREE WITH THIS ISSUE**  
**16-PAGE WHAT SCANNER MAGAZINE**

**Reviewed This Month**

**HOKA DATA  
DECODING  
SOFTWARE**

**Plus**

**BUILD A  
SIMPLE MW  
RECEIVER**

**And**

**Regular  
Features for  
Broadcast,  
Airband  
and Scanning  
Enthusiasts**

## WHAT SCANNER

AUTUMN 1990  
£1

**WHAT SCANNER**  
*Comprehensive details  
of available makes*

**NEWSCAN**

**WHAT IT ALL MEANS**  
*Terminology Explained*

**Reviews**

**BLACK JAGUAR**

**HOWES AA2 ACTIVE  
ANTENNA**

**Plus**

**SCAN THESE!**  
*Handy Book Reviews*

**SCANNING THE MARINE  
BANDS**

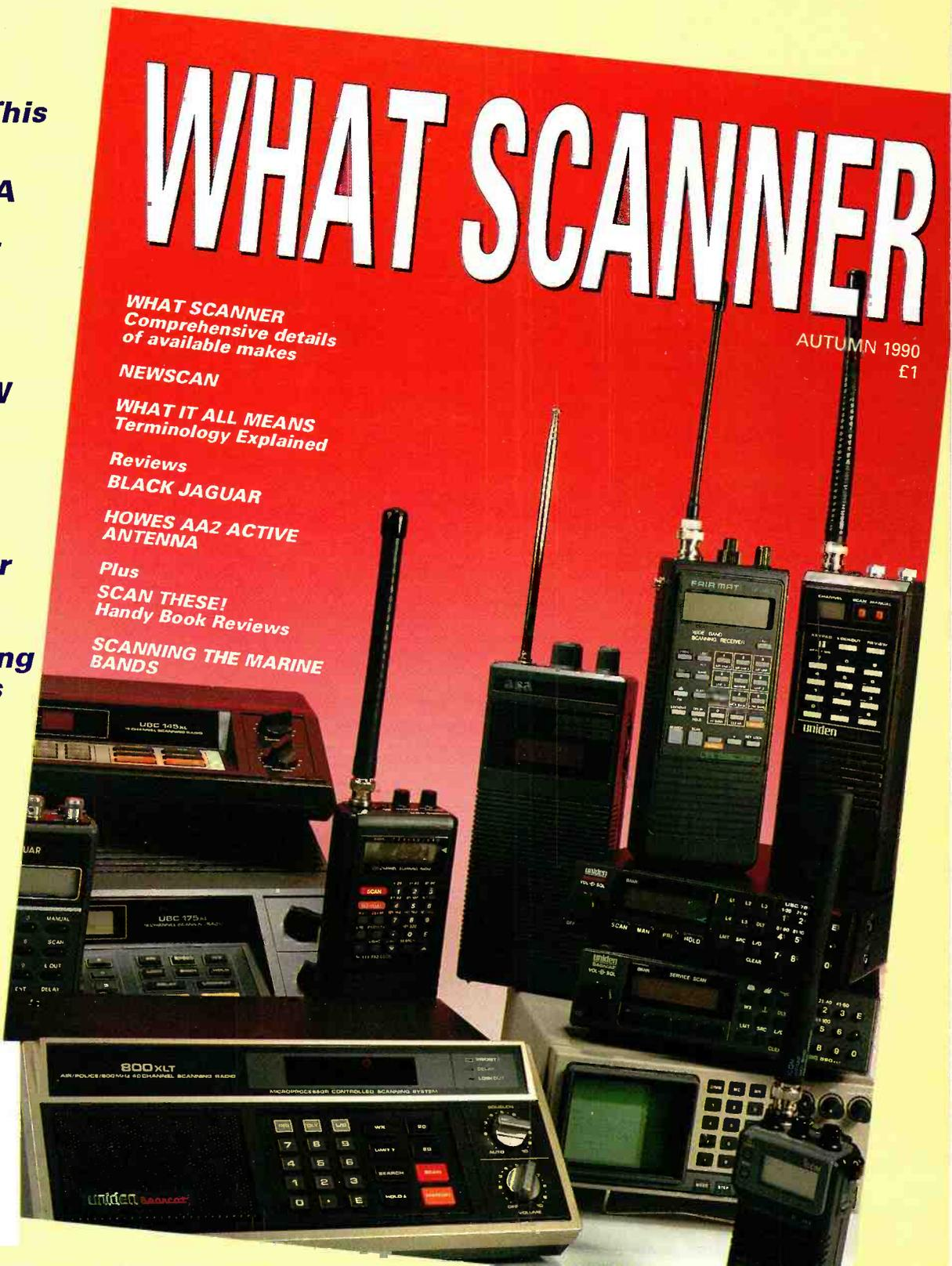

ISSN 0037-4261



9 770037 426005

# uniden®

## High Quality Scanners

### Model UBC200XLT

The Rolls Royce of pocket scanners with 200 memory channels in 10 banks. The set covers 12 bands including Airband, Marine and 900Mhz.

Facilities include Priority Scan, Squelch, Lock-out, Delay, Key Pad Lock.

A removeable re-chargeable battery pack allows easy charging with a mains charger included.

### Model UBC100XLT

A 100 memory channel version of the UBC200XLT handheld scanner.

### Model UBC175XL

A slimline base scanner with 16 memory channels covering Airband, Marine and Public Service Bands.

Full Scan functions as with other Uniden models.

### Model UBC760XLT

A new slimline mobile or base scanner with 100 memory channels. Covers Airband, Marine, 900Mhz and much more.

Features include Easy to Read LCD Display, Squelch, Automatic and Manual Scan, Delay, Priority, Search Lock-out, Key Pad Lock and Tape Recorder/Speaker Socket.

AVAILABLE FROM AUTHORISED DEALERS THROUGHOUT THE UK.



For more information on the complete UNIDEN range contact UK Distributors:-

**NEVADA**

189 LONDON ROAD, NORTH END, PORTSMOUTH, HAMPSHIRE  
PO2 9AE TELEPHONE: (0705) 662145 FAX: (0705) 690626

# LINIPLEX LOOP ANTENNA

Mile Richards G4WNC

I have been fascinated by the advertisements for this unusual antenna, so welcomed the opportunity to have a closer look. The basic specification was certainly very comprehensive with a frequency coverage from 50kHz right through to 30MHz with no band switching. There are very few antennas around that perform well over such a wide range, so I was particularly interested in checking out the on-air results. So enough waffle, let's get on with the review.

## Putting it Together

The first item that is required with a system like this is a good manual. In the case of the Liniplex, the manual was supplied as an eleven-page, A4 document bound in a floppy plastics binder. The first part of the manual, logically, concentrated on the assembly detail. I think this section could have been improved with the addition of a few

**Many listeners have problems finding room for antennas, so any product that eases the problem is welcome.**

more diagrams, as I could see the novice having problems.

The importance of proper siting and feeding options was dealt with next and this was very well covered. The final section gave p.c.b. layouts and a full circuit diagram. This represented a welcome openness that is so often missing with peripheral equipment manufacturers.

From the illustration you can see that it's not practical to post the Liniplex fully assembled! As a result, the antenna was supplied part assembled. The assembly process required the user to separate out the pre-wired radials and clip them into the central hub. Although this took

about ten minutes for the review model, untangling the wires was a little fraught.

Besides the main antenna there were two plastics boxes each measuring 120 x 80 x 55mm. One provided the line feed and was located in the shack, while the other was the loop amplifier that had to be mounted next to the antenna.

One unusual feature of both these units was that they had transparent lids, so you could see the p.c.b. Although this was of novelty value, there was one advantage in that you could see the settings of the internal slide switches.

The recommended mounting position for the antenna was a convenient 1.5m above the ground. To simplify mounting both the antenna and loop amplifier on a mast, both units were fitted with clamps. The maximum mast diameter was 32mm, but the manual did give a suggestion as to how the unit could be mounted on a larger diameter mast.

The connection between the antenna and the loop amplifier was by a three-pin plug. Weather-proofing being achieved by a simple rubber sleeve. The link back to the line feed unit was via a coaxial cable (supplied) fitted with BNC connectors. It was interesting to note that the antenna end of this cable was fitted with a military specification BNC plug. Although this type of plug may offer a degree of weather protection, I would be very inclined to add some self-amalgamating tape for peace of mind.

At the shack end, the line feed unit had BNC sockets for the antenna feed and the output to the receiver. At this point it is probably appropriate to mention that there were, in fact, two options for the feed between the line feed unit and the loop amplifier.

The standard system using a single feeder was unbalanced and should be fine in most circumstances. However, there may be occasions when, due to the cable run, interference is coupled into the outer of the cable and so passed on to the receiver.

The Liniplex has an optional feeder system that has been designed to overcome this problem. The system uses two feeders between the loop amplifier and the line feed unit. The antenna signal being distributed between the two cables as a balanced feed. Selecting the balanced option was simply a case of operating a slide switch in line feed and loop amplifier.

The next stage was to connect the line feed unit to the receiver. This was conveniently achieved using the supplied BNC to PL-259 lead. Power was next and that was supplied by a sealed, external transformer that was permanently wired into the line feed unit.

I must admit the final presentation of the Liniplex was very smart, if perhaps a little unusual.

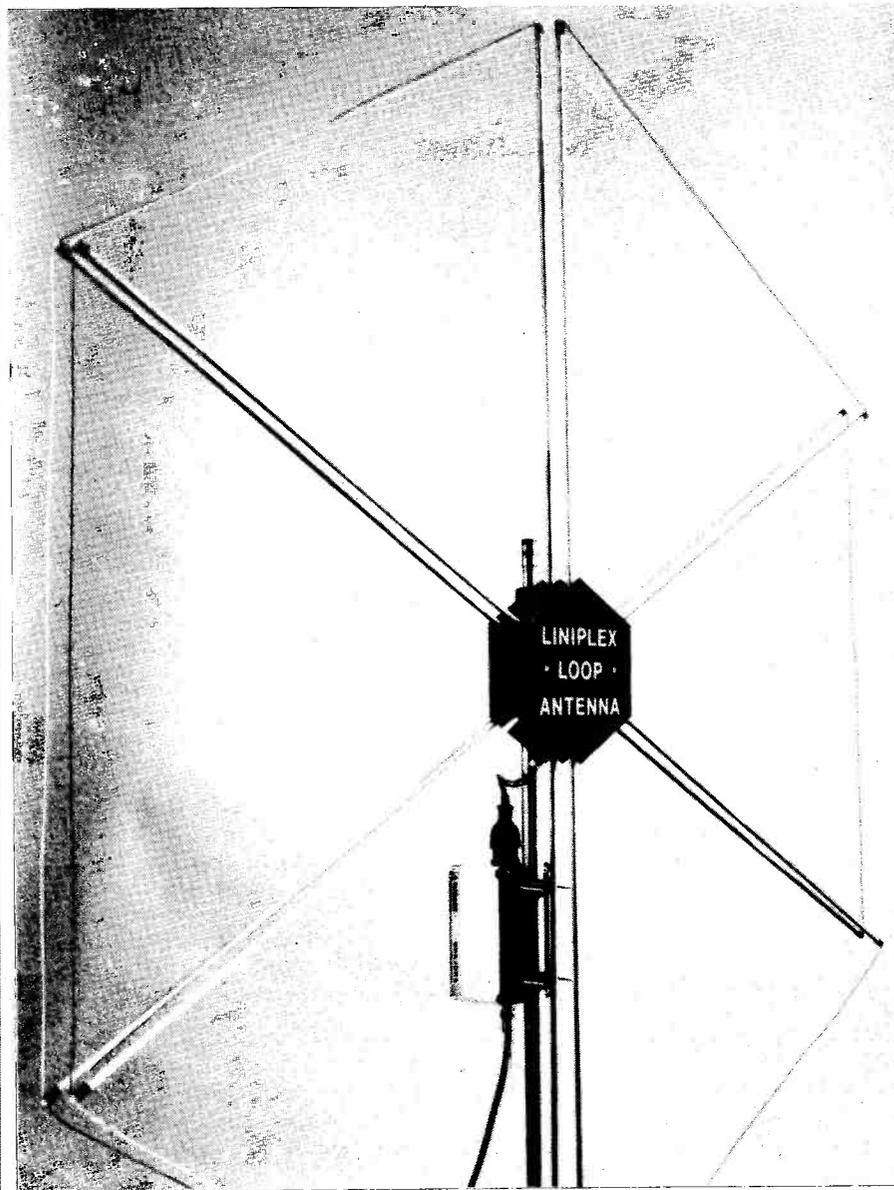

# LINIPLEX LOOP ANTENNA

## The Acid Test!

The Liniplex is one of many antenna designs on the market and, of course, the most important question is - does it work? The simple answer is yes, but a little more explanation is justified.

For the on-air tests the antenna was mounted on a wooden pole approximately 1.5m above the ground, as recommended in the manual. The receiver used for the tests was an Icom IC-720A amateur transceiver with general coverage receiver. To gauge how well the Liniplex was performing, it was compared with my full size G5RV antenna.

One final point on the tests concerns the ground conductivity. This is important because the horizontal sensitivity of the Liniplex is related to this factor. In the case of the review site, the ground conductivity is known to be very good.

So, having set the scene, it was time to check out the performance. The first task was to check the relative sensitivity throughout the wide operating range. The results here were surprisingly good for such a small antenna. The signal strengths from both antennas were pretty much equal from 1.0MHz through to 15MHz. At frequencies above 15MHz the signal strengths gradually dropped, to the worst case of 6dB below that of the G5RV.

At the lower end of the spectrum the situation was reversed. Here the Liniplex was well controlled and produced respectable signal strengths right down to v.l.f. The G5RV, not surprisingly, did not perform too well at these low frequencies.

This is not a slight on the G5RV as it was never intended for use outside the

amateur bands. But, even with the G5RV strapped to form a vertical T, it was still out-performed by the Liniplex.

Another area where the Liniplex scored was computer interference rejection. I use an IBM PC for l.f. FAX reception but this causes a high level of QRM at v.l.f. When I used the Liniplex, this interference was greatly reduced, even though the Liniplex was only 3m from the computer.

Although signal strength is important it's not the whole story. What is really important is the final signal quality. It was here that the compromises of this active antenna became clear.

When listening to the comparative signal quality of the two antennas it became clear that the signal to noise ratio from the Liniplex was worse than the G5RV. This is no more than I would expect as the small capture area of the Liniplex has to be compensated by amplification. It is this amplification that deteriorates the signal to noise ratio.

Another important aspect of the Liniplex's performance was directivity. The horizontal capture pattern was a

figure of eight, whilst the vertical pattern was semi-circular. The horizontal directivity had the potential to be very useful for nulling out interfering signals. In practice the directivity was not very marked. This was simply because the majority of h.f. signals arrive at a vertical angle and so miss the figure of eight pattern. In most cases the depth of null attainable was in the order of 10dB.

Although the null depth was comparatively small, its presence does imply that the antenna needs some form of rotator. If this is not done you can rest assured that the signal in the null will be the one you want!

## Summary

Considering its size the Liniplex performed well during the tests. The standard of construction was very good and it had a look of quality. The directional properties of the antenna were a mixed blessing as some sort of rotation system may well need to be employed.

Overall then, an interesting antenna that will no doubt find favour with those who are unable to erect more conventional antennas due to restricted space.

The Liniplex loop antenna costs £396.75 in the UK and includes 15m of RG58 feeder, 1.5m adapter cable with SO239 connector for a receiver and mains power supply. Carriage is an additional £13. The antenna is supplied by **Phase Track Ltd., 16 Britten Road, Reading RG2 0AU. Tel: (0734) 752666**, who I would like to thank for the loan of the review model.

It is also available in Germany from: Alltronic GmbH, Eichborndamm 178, D-1000 Berlin 51, West Germany. Tel: 030 414 50 65. □

Abbreviations	
BNC	type of coaxial connector
dB	decibel
FAX	facsimile
kHz	kilohertz
l.f.	low frequency
m	metre
MHz	megahertz
mm	millimetre
p.c.b.	printed circuit board
PL 259	type of coaxial connector
QRM	man-made electrical noise
v.l.f.	very low frequency

## SHORT WAVE MAGAZINE PCB SERVICE

Printed circuit boards for SWM constructional projects are now available from the SWM PCB Service. The boards are made in 1.5mm glass-fibre and are fully tinned and drilled. All prices quoted in the table include Post and Packing and VAT for UK orders.

Orders and remittances should be sent to: **PW Publishing Ltd, FREEPOST, Enefco House, The Quay, Poole, Dorset BH15 1PP**, marking your envelope **SWM PCB Service**. Cheques should be crossed and made payable to PW Publishing Ltd.

When ordering please state the Article Title as well as the Board Number. Please print your name and address clearly in block capitals and do not enclose any other correspondence with your order. You may telephone your order using Access or Visa. A telephone answering machine will accept your order outside office hours.

**Please allow 28 days for delivery. Only the p.c.b.s listed here are available.**

Board	Title of Article	Issue	Price £
SR006	Medium Wave AM Radio	Nov 90	3.34
SR005	R210 Converter	July/August	6.87
SR004	PRO-2004 Modifications	Oct 89	6.63
SR003	HF to VHF Converter	Aug 89	5.22
SR002	Weather Satellite Reception	Jun 88	3.88
SR001	Audio Filter	Jul 87	6.00



Telephone orders: (0202) 665524

# AMATEUR RADIO SATELLITES

Arthur C. Gee G2UK  
Part 2

Amateur satellites are small, complex spacecraft that have been launched into orbit around the earth. They can be put into a circular orbit about 1000km above the earth's surface or into an elliptical orbit which passes well out into space at its furthest point from the earth - apogee - and close into the earth at its nearest point - perigee. These two types of orbit are shown in **Fig. 2.1**.

It must be realised that once in an orbit around the earth, it stays in that orbit until such time as various things happen to change it, bringing the satellite back into the atmosphere where it burns up. On the other hand, the earth is rotating on its north/south axis once every 24 hours, giving us day and night and tilts back and forth on its axis, giving us summer and winter.

**What exactly are amateur radio satellites and what uses have they? What is the manner of their passage through space and how can this be predicted?**

in space, signals being returned from it come down at a far greater distance than they do in the ionosphere and you can hear Japanese, American, Australian and similar DX stations far more easily than via the usual h.f. bands. Very much higher frequencies can be used which are not refracted by the ionosphere so that this freedom from 'bending' can be taken advantage of. Apart from listening for DX

stations, as we saw last month in Part 1, satellites such as UoSATS send back to earth all sorts of data of a scientific interest such as telemetry, c.w. or data information on temperature, voltages, etc., on the satellite and much else. This can be copied in various degrees of complexity, depending on the interest of the s.w.l. You can even set up a receiving system to receive c.c.d. camera pictures from some of the satellites if you like to get involved to this extent. Another angle the s.w.l. can undertake is simply monitoring the satellites, recording their times of appearance and the characteristics of their signals and so on and reporting this regularly to the various organisation interested in these matters. Again you can listen for 'unlisted' satellites which show up from time to time. The tracking, recording and monitoring of these can be a most fascinating activity. So, if you wish, these is an endless series of interesting aspects you can participate in.

## Getting Started

How do we get started, then? We have already dealt with the requirements of the receiver and its antenna. We now need to know when we can hear the satellites.

The easiest way to do this is to make use of an 'Oscalator Tracker' and a booklet of orbital prediction tables. Referring back to the model globe mentioned above, it is possible to represent the motions

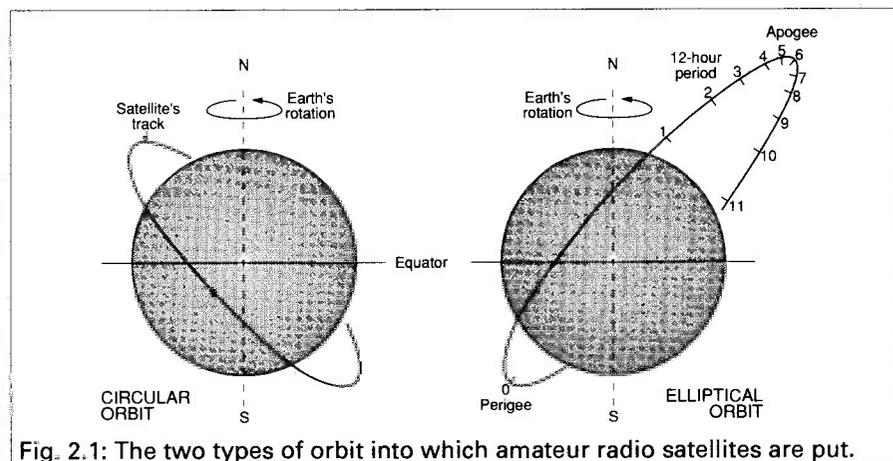
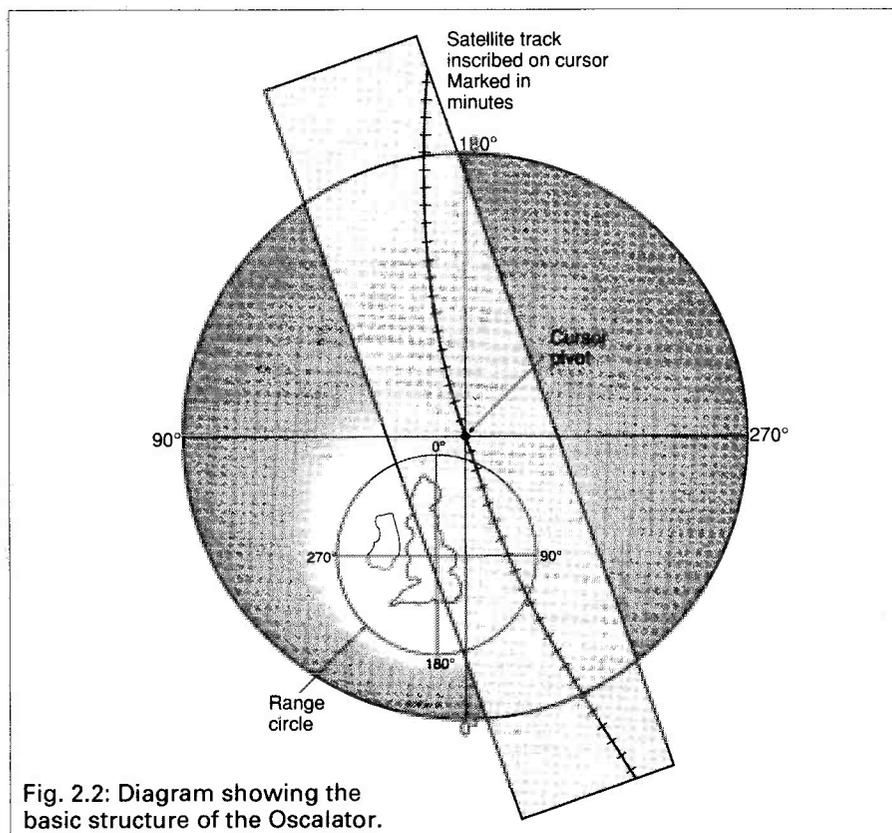

**Fig. 2.1: The two types of orbit into which amateur radio satellites are put.**

All this means that the satellite's path traced out on the surface of the earth is a very complex one indeed, which will have a very significant effect on the position and direction of an antenna set up to receive its signals. It is this aspect of amateur satellite activity which puts some otherwise interested s.w.l.s off.

However, as we shall see, its not so confusing as it might at first seem. A few simple gadgets have been devised to take the confusion out of it! You can get a good idea of what is going on by getting a small globe of the world and fixing a ring of wire around it going from pole to pole, about 12mm or so above the globe's surface. Slip a glass or wooden bead on the wire before you fix it to the globe. Then you can spin the globe round on its pivot and as you move the bead along the wire you'll see just how complicated their respective motions are one to the other.

What do amateur satellites do? Well, those intended for communications, provide communication facilities between amateur radio stations in much the same way as h.f. radio does, with the advantage that DX can be worked very much more easily than on the h.f. bands. As the satellite is high up in the sky or out



**Fig. 2.2: Diagram showing the basic structure of the Oscalator.**

# ARE

**COMMUNICATIONS**  
THE SHOP WITH THE SMILE

WE SELL ALL  
WELL-KNOWN  
BRANDS LET US QUOTE  
FOR YOUR CHOICE  
**KENWOOD — ICOM — STANDARD**

ONLY FROM US -  
WITH SSB  
NOW ONLY

**£499**



IC-R100 Mobile/Base Receiver  
now with **SSB!**

**WHY SETTLE FOR ANYTHING LESS!**

For the enthusiast who prefers a more permanent installation the IC-R100 is ideal giving full frequency coverage of 500kHz-1800MHz and AM/FM. FM wide modes of operation. The IC-R100 boasts 100 memory channels to store your favourite stations and has features similar to the little pocket receiver. 48 monthly payments of 17.97.

## IC-R1



This scan receiver now at a new **AMAZING** price

**£379**

Frequency range 100kHz to 1300MHz no gaps A.M. or F.M. Also available on easy terms.

**48 payments of £13.65 per month.**

**Other Scanners Available - JUPITER II FAIRMATE UNIDEN**

## ICOM

### IC-725 or 726

HF Transceivers for both mobile or base - the 726 has 6 metres inc.



**PHONE FOR OUR PRICE YOU MIGHT BE AMAZED.**

## IC-R72

### THE NEW ICR72 RECEIVER 100kHz to 30MHz SSB AM CW

Powered by either internal batteries or external supply. Superb selectivity and sensitivity

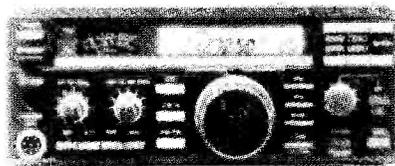

**PHONE FOR OUR PRICE**

## ICR7000 HF

### HF Receiver 500kHz - 2GHz



Now available on super credit terms. 48 Monthly payments of £35.61. Cash/cheque/credit card price.

**£989** with HF Fitted

Yes, 500kHz to 2 GHz **CONTINUOUS** receive in one unit



a.p.r. 34.4%

## YAESU

NOW INCLUDING FM BOARD  
**YAESU FT 747**  
NOW **£499** Inc VAT  
CW & AM Filters are available if required.



**AVAILABLE WITH NO DEPOSIT AND 48 MONTHS TO PAY - £17.97**

The FT747 HF Transceiver SSB/CW/AM (and optional FM) 100 Watts pep output on all HF Bands and general coverage on receive 100kHz-30MHz. Dual VFO 20 memories. Altogether a super economical HF Transceiver.

## A DREAM COME TRUE

**Bored with two metres?  
Then why not turn that 2m rig  
onto the HF bands**

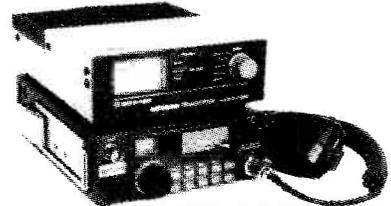

**FT290R II £395 2 METRE TRANSVERTER  
TOKYO HX240 £249**

With the HX 240 feed in 3 to 10 watts on 2m and transmit on 10-15-20-40 or 80 with 40 watts output.

## KENPRO

Once again **A.R.E. COMMUNICATIONS** BREAK THE PRICE BARRIER! Now a 2 Metre Hand Held transceiver made by Kenpro. Model

**KT22E for £129** inc. VAT

Package includes NICAD pack charger and antenna

- ★ Fully synthesised
- ★ Thumbwheel tuning
- ★ 10MHz cover on RX
- ★ 1750kHz Tone Burst
- ★ 600kHz Shift for repeater operation
- ★ Low and High power switch

**£129**  
or 12 Monthly payments of £12.58



**YOURS - FOR LESS THAN 50P PER DAY**

**PHONE 081-997 4476**



Opening Hours Monday-Friday 9.30-5.30

**NOW OPEN SATURDAY 10.00-5.00pm**

ARE Communications Limited. 6 Royal Parade. Hanger Lane. Ealing. London W5A 1ET. England

Tel: 081-997 4476 Fax: 081-991 2565

# RADIO AMATEURS EXAM? PASS FIRST TIME!

**Before you enrol check the benefits of  
RRC'S unique Home Tuition Service**

RRC has helped thousands of students to success in their examinations with this unique system of postal tuition, one which guides you, step-by-step, to qualify in the shortest possible time. Only The Rapid Results College offers you all these advantages:

- |  |   |
|--|---|
| <input checked="" type="checkbox"/> A qualified personal tutor             | <input checked="" type="checkbox"/> Free advice before you enrol                    |
| <input checked="" type="checkbox"/> Study material prepared by specialists | <input checked="" type="checkbox"/> Telephone Helpline                              |
| <input checked="" type="checkbox"/> Completely self-contained courses      | <input checked="" type="checkbox"/> Free 'How to Study' Guide                       |
| <input checked="" type="checkbox"/> Handy pocket-sized booklets            | <input checked="" type="checkbox"/> Instalment Plan                                 |
| <input checked="" type="checkbox"/> Personal study programme               | <input checked="" type="checkbox"/> Free Postage on course material                 |
| <input checked="" type="checkbox"/> Regular marked tests                   | <input checked="" type="checkbox"/> Worldwide Airmail Service                       |
| <input checked="" type="checkbox"/> Courses regularly updated              | <input checked="" type="checkbox"/> Extra tuition free if you don't pass first time |
| <input checked="" type="checkbox"/> 48 hour despatch                       |   |

**POST COUPON TODAY FOR FREE RADIO AMATEURS PROSPECTUS**  
Please send me my prospectus as quickly as possible.

Mr/Mrs/Miss/Ms \_\_\_\_\_

Address \_\_\_\_\_

Postcode \_\_\_\_\_

**RRC** The Rapid Results College   
Dept. JV101 Tuition House, London SW19 4DS. FREE ADVICE 081-947 7272 (9am-5pm)  
PROSPECTUS: 081 946 1102 (24 hour Recordacall Service quoting Dept. No. above.)

**SSE** HIGH QUALITY ACCESSORIES  
FOR SCANNING MONITOR RECEIVERS

**JIM PSU-101**

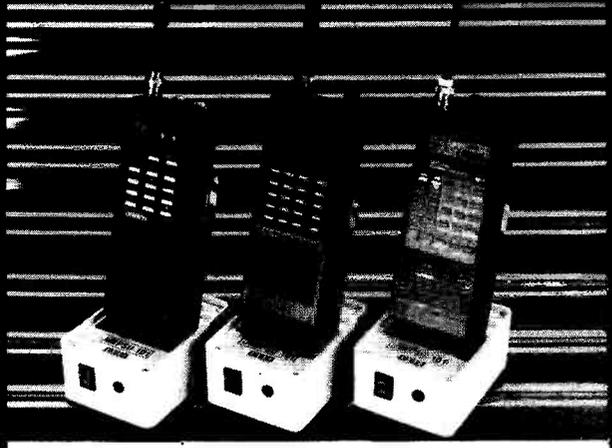

- JIM PSU-101MKII.** A high quality UK manufactured fully regulated 220-240V AC power supply with Radio Base Holder combined! For use with: FAIRMATE HP-100E, AR-1000, YUPITERU MVT-5000, REALISTIC PRO-38, ICOM IC-R1, UNIDEN UBC50XL, BC55XLT, UBC70XLT, UBC200XLT, UBC205XLT, UBC100XLT. Special version available with 9VDC or or 6VDC for PRO-34 or WIN108 etc. **PRICE: £26.50**
- JIM BC14A.** A newly developed constant current Ni-cad charger with inbuilt charge timer control. No more worries about over-charging. Auto-switch-off after 14-15 hours. Ideal AOR900, 800, 850, CB Handhelds etc. **PRICE: £19.50**
- JIM AF15.** Protect your mobile scanner etc. when used with mains supply from overvoltage caused by power supply failure. Why take the risk! Fit the AF15 today. **PRICE: £15.85**

Payment by postal order or cheque. Prices include postage.  
Further information on SSE products send A4 SAE to: **Solid State Electronics (UK)**, 6 The Orchard, Bassett Green Village, Southampton SO2 3NA. Tel: (0703) 769598.

**NEW**  
PSU-101 MAIL

**BBC WORLD MAIL ORDER**



**PASSPORT TO WORLD BAND RADIO 1991**

The 1991 guide to shortwave listening is now available.  
*It includes:*  
Complete SW listening guide by frequency  
Buyer's guide to SW Radios  
In-Depth articles on SW

**Price £14.95 post free. Published September 1990**

BBC WORLD MAIL ORDER DEPT SW-NOV BUSH HOUSE, STRAND LONDON WC2B 4PH	Allow 28 days for delivery. Pay by cheque to BBC World or by Access, Visa or Amex Please quote number & expiry date
--	--

Visit BBC World Service Shop, Bush House, Strand  
Mon-Sat 10-5 (Holborn or Temple Tube)  
Shortwave Books and Receivers, Media and Broadcasting Books.

# MARCO TRADING

## ELECTRONIC COMPONENTS & EQUIPMENT

**MAIL ORDER • WHOLESALE  
RETAIL**



**LATEST 1991 CATALOGUE  
AVAILABLE NOW**

- ★ Free pre-paid envelope
- ★ Many new lines
- ★ Pages of special offers
- ★ Free gifts

**SEND: £1.50 to:**  
**Marco Trading**  
 Dept PW10  
 The Maltings  
 High Street  
 WEM Shrewsbury  
 SY4 5EN  
 Tel: 0939 32763

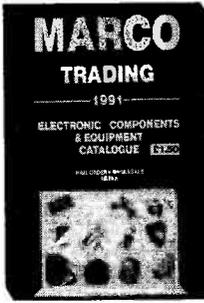



# AMATEUR RADIO SATELLITES

indicated by the globe model on a flat surface. This provides the basis for a tracking calculator, from which we can calculate the place, time and position of the satellite in its orbit around the world.

The 'Oscalator' consists of a sketch map of one or other of the world's hemispheres - in the UK of course it is the Northern Hemisphere - glued on to a suitably sized piece of stiff card or plywood. The North Pole of the map centres on the centre of the board upon which the map is glued. A transparent cursor is provided with the 'Oscalator' kit, on which is marked the track of the particular satellite we are going to listen for.

The mid-point of the track is marked on the cursor and the cursor is fixed through this point to the map, with a paper fastener or other suitable fixing to give a pivot to the cursor so that it can be moved around the map. This is made

clearer in **Fig. 2.2**. A different cursor is needed for each satellite as the track of the orbit of each satellite does vary one from another. In actual practice several of the satellites do have similar orbits, so one 'Oscalator' will do for more than one.

## Orbital Prediction Tables

In addition to the map tracking board, we need some orbital prediction tables. These tell us just where the satellites orbital path is in relation to points on the earth's surface. It gives the times the satellite crosses the equator and the longitude of the crossing for each day during the period covered by the tables.

These tables are produced in booklet form and are known as an *Orbital Prediction Calendar*. They usually cover a period of two months or so and have predictions for the most popular amateur

satellites. The *Calendars* are issued to members of AMSAT-UK every two months for a small additional subscription. Details can be obtained from AMSAT-UK, 94 Heronsgate Road, London E12 5EQ. Don't forget an s.a.e.

With an *Orbital Prediction Calendar* and an *Oscalator*, you can obtain all the information you need for knowing the time the satellite will be available for use in your particular location and the bearing of a beam antenna when you start to use this type of antenna, as you will no doubt do once you have gained some experience of 'satellite-working'!

So, why not get an *Oscalator* kit from AMSAT-UK and a copy of the current *Orbital Predictions Calendar*? If you can get the kit made up by next month, when we describe in more detail how to use them, you will have them ready and be able to understand the instructions much more easily. □



Abbreviations	
c.c.d.	charge coupled device
c.w.	continuous wave (Morse)
DX	long distance
h.f.	high frequency
km	kilometres
mm	millimetres
s.w.l.	short wave listener

**Fig. 2.3:** A model showing the comparison between the circumference of the world and the track out into space of a satellite in an elliptical orbit (Molniya orbit).

## WHAT'S NEW EXTRA

### Catalogues, Brochures & Newsletters

Hamlin has produced a readable 19-page brochure on its magnetic sensors. Well-illustrated, it incorporated information on the basic theory and operation of the devices, factors affecting contact closures, temperature effects on sensor sensitivity, the benefits of reed proximity sensors, load/life performance details, etc.

A comprehensive guide to the various application areas for these products is included. In the automotive area, for example, the latest electronically-activated air bag systems and brake fluid and washer fluid level detection are reviewed. For fluid handling, power pump showers are highlighted. Other applications are in the area of mechanical handling where hydraulic/pneumatic cylinders and linear actuators are featured. **Hamlin Electronics. Tel: (0379) 644411.**

Marco Trading have sent us their 1991 Electronic Components and Equipment Catalogue. It is available for £1.50 from: **Marco Trading, The Maltings, High Street, Wem, Shrewsbury SY4 5EN. Tel: (0939) 32763.**

Unitel has produced a comprehensive brochure on its range of fuses and fuseholders. The range of fuses from Beswick, Littlefuse and Siba cover T, F and FF types, glass and ceramic, in both 20 and 5mm and 1.25 x 0.25in dimensions. Details are also provided on axial lead fuses from Littlefuse.

The fully illustrated brochure highlights an extensive selection of fuseholders from Bulgin, Littlefuse and Schurter in varying styles. Information is also provided on fuseclips and fuseblocks. Copies of the brochure are available, free-of-charge, from **Unitel. Tel: 0438 312393**

The latest Tandy 1990-91 Electronic Catalogue is now available free-of-charge from over 500 Tandy Stores and Authorised Dealers throughout the UK. Produced annually the full-colour 140-page catalogue contains a complete section by section showcase guide through the product range and features details on all Tandy Stores and Dealers.

Anyone wishing to obtain the new Tandy Catalogue should simply visit their local store or dealer.

*Antique Wireless Newsheet No. 138* arrived in the SWM offices from the Vintage Wireless Company Ltd. This month's newsheet contains a large components and bits & pieces section, details of more 'standard stock items' such as high impedance headphones, audio anthology Vol 3 and rubber 'revitaliser' and a re-introduction of the audio and radio repairs at their workshop.

The newsheet is normally issued at regular intervals and each subscription is for 12 issues. For the UK the rate is £5, overseas (including Eire) it's £6.00. **The Vintage Wireless Company Ltd. Tudor House, Cossham Street, Mangotsfield, Bristol BS17 3EN.**

The DX Association of Great Britain's latest

newsletter makes interesting reading, as usual. There's a review of the Lowe HF-225 receiver, details of broadcast stations schedules, what's been heard on the band, computing in radio and aviation and radio part one to mention just a few of the items.

Subscriptions cost £10 for the UK and Eire, £11 for Europe and £15 world-wide. **D Young, 44A Porter Terrace, Murton, Co Durham SR7 9PT.**

The latest issue of *Radiophile* is another good read. The principle items in this month's copy are a profile on the General Electrics L-643 and L-651 radios, Investigative Servicing, Bunfight at the OK Corral, Maths made Tolerable and the information department.

A six issue subscription costs £10 for UK and Eire, but is likely to go up soon because of rising postage charges. **Radiophile Larkhill, Newport Road, Woodseaves, Stafford ST20 0NP.**

The **Maplin 1991 Buyer's Guide to Electronic Components** will be available from WH Smith, Maplin shops or direct by mail order from September 7., price £2.45 (+50p if ordered direct - UK price). This year also there are many more 'famous brand products' featured such as Black and Decker and MiniCraft tools, 'Big Cat' Eminence loudspeakers. New product lines also include Kodak films and Olympus camera and extended product ranges include batteries, books, cable, protection devices, tools and projects.

# COMMUNICATIONS

## BEARCAT SCANNERS

Recently appointed as the UK distributors for this high quality product range — we offer the complete selection of mobile and base scanners with full service back up.

### BEARCAT BC800 XLT

Base Scanner with 900MHz UHF Band

Fantastic Value at ..... £149

\* 40 Channels of Memory

\* 240V AC Mains

\* Covers 29-54, 136-174, 118-136, 406-512, 840-912MHz

SPECIAL PURCHASE

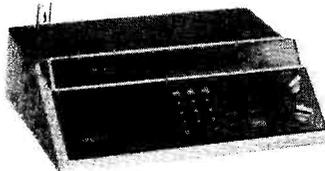

### BEARCAT UBC 175 XLT

(16 CH. Memories) An economical base scanner covering all the popular aircraft, marine and public service bands.

Coverage 66-88, 118-174, 406-512 MHz ..... £169.99



### BEARCAT 760XLT

New Model with 900MHz Coverage

With 100 memory channels and coverage of the UHF band, the 760XLT is ideal at home or in the car. Pre-programming of preset bands is possible for fast access. Freq.

Coverage 66-88, 136-174, 406-512 MHz) ..... £235



### UBC 145 XLT (16 CH. Memories)

A low cost base scanner suitable for marine and public service reception

Coverage 66-88, 136-174, 406-512 MHz ..... £115

### BEARCAT HANDHELD SCANNERS

UBC 50XL (10 CH MEM.) ..... £99.95

(66-88 MHz, 136-174 MHz, 406-512 MHz.)

BC 55 XLT (10 CH MEM.) ..... £99.95

(29-54 MHz, 136-174 MHz, 406-512 MHz)

UBC 100XL (16 CH MEM.) ..... £179

(66-88 MHz, 118-174 MHz, 406-512 MHz)

UBC 100XLT (100 CH MEM.) ..... £199

(66-88, 118-174, 406-512 MHz.)

### UBC 200 XLT

200 CH MEM.

(66-88, 118-174, 406-512, 806-956 MHz.)

£229

The 100 XLT and 200XLT handhelds feature removable battery packs for easy charging - and have proved popular because they are simple to operate giving excellent performance and reliability.



## SONY RADIOS

We are the main short wave stockist

Sony ICF SW1E Short Wave + VHF, world's smallest s/wave radio ..... £149.95

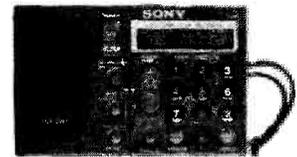

Sony ICF 2001 D (150kHz-136MHz) . . . . . £275

Sony ICF 7600 D Pocket s/wave s/hand. .... £99

Sony Air 7 airband h/held. .... £229

Sony Pro 80 wideband h/held. .... £299

Sony AN1 active antenna. .... £49

## COMMUNICATIONS RECEIVERS

Low HF225 (30kHz-30MHz) ..... £429

Kenwood R2000 (150kHz-30MHz)

10 memories. .... £595

Kenwood R5000 (100kHz-30MHz)

100 memories. .... £875

ICOM R71E (100kHz-30MHz)

32 memories. .... £855

ICOM R9000 (100kHz-2GHz)

1000 memories. .... £3995

## LOW NOISE PRE-AMPLIFIERS

### MODEL M75

For base and handheld scanners.

• 25—2100 MHz

• Low noise GaAs FET

• Selectable filters for improved performance

• Variable Gain Control ..... £69.95

These new Pre-Amplifiers are a must for the scanner enthusiast and will allow reception of signals that were inaudible without them.

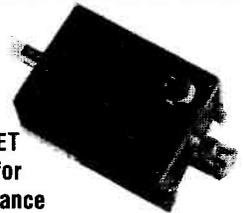

### MODEL M100

Same spec as M75 but with full RF switching, may be used with transceivers on transmit up to 5 watt o/p power ..... £79.95

### MODEL M50

A new low cost pre-amp without filters or gain control. Offers low noise GaAs FET at 20 dB fixed gain. .... £49.95



Nevada

Communications

189 London Road

North End

Portsmouth PO2 9AE

HOTLINE

(0705) 662145

FAX (0705) 690628

DISTRIBUTORS OF RADIO COMMUNICATIONS EQUIPMENT

WITH DEALERS THROUGHOUT THE UK & EUROPE

FAST MAIL ORDER SERVICE WE SHIP WORLDWIDE

# STOCKIST OF SCANNING RECEIVERS

## BLACK JAGUAR MkIII

Independantly tested by a European magazine, the Black Jaguar was found to be the most sensitive handheld scanner on the market! That probably explains why it is still so popular. Features include 16 channel memories, selectable AM/FM and the facility to power the set from the mains/car using one of the many accessories now available. Covers civil and military airbands plus lots more! Frequencies: 28-30, 50-88 MHz, 115-178 MHz, 200-280 MHz, 360-520 MHz



£199

## BLACK JAGUAR ACCESSORIES

- (SUITABLE FOR ALL MODELS, BJ200, CHALLENGER ETC.)
- Mobile Mount ..... £6.95
  - Base Mount ..... £5.95
  - BJ1 Car Supply (Mk111 version only) ..... £14.95
  - BCA6 Mains Slow/Fast Charger ..... £14.95
  - Airband Rubber Duck Ant ..... £6.75
  - SA7 UHF Stub Antenna ..... £5.95
  - Telescopic Antenna ..... £6.75
  - BCA3 Mobile Antenna Charger ..... £14.95

## AOR SCANNERS

**AR 3000** wideband scanner 100kHz to 2036MHz with no gaps! Now available ..... £765



- AR 2002** popular base scanner with coverage 25-550 MHz, 80-1300 MHz and 20 memory channels ..... £487
- AR 950** new low cost base with 900 MHz UHF band ..... £249

## MASTHEAD ANTENNA SWITCH

For Scanning Enthusiasts select 2 antennas at the masthead remotely from one cable. Frequency: DC to 1.3 GHz Connectors: 'N' Type ..... £49.95

## JUPITER SCANNERS

- MVT 5000** Handheld (100 mem.) (25 - 550MHz, 800 - 1300MHz) ..... £249
- MVT 6000** Mobile (100 mem.) (25 - 550MHz, 800 - 1300MHz) ..... £299

## ICOM

NEW

We are ICOM specialists and carry the complete range in stock including these NEW models:-

**IC-R1** The new miniature wideband handheld scanner that covers 150kHz to 1300 MHz with 100 memories and many features.....£399



**IC-R100** Mobile or base extra wideband scanning receiver covering 500kHz to 1.8GHz with 100 memory channels and reception of AM, FM, WFM ..... £499

**IC-R72** A new HF communications receiver covering 100kHz to 30MHz. Receivers SSB/AM/CW with FM board as optional extra 99 memory channels and 10dB pre-amp fitted as standard ..... £645

**IC-R7000 ICOMS** Most popular communications receiver. Covers 25 MHz to 2 GHz with 99 memories and all mode reception ..... £925

Call Paul our ICOM specialist for details of other ICOM amateur radio products we stock - or for details of the latest models and prices.

**STOP PRESS** Arriving Soon

## NEW YUTPITERU VT125 Super Sensitive Airband Radio

Features:—  
30 Memory Channels  
Frequency:— 108—142MHz  
Search Steps: 100/50kHz  
Priority — Lockout — etc.  
Since our recent appointment as Yutpiteru Distributors — more new products are on the way — WATCH THIS SPACE! £169



## LOW LOSS JAPANESE COAX

Essential for optimum performance with wideband UHF scanners. We have directly imported this cable which has exceptional low loss and is good for frequencies up to 3 GHz. Loss at 1 GHz for 10 mtrs is 1.3 dB  
MODEL 8D (11.1mm) ..... £1.40 per MTR  
MODEL 5D (8.1mm) ..... £0.56 per MTR

## BOOKS

- Short Wave Confidential Freq List ..... £8.95
- VHF/UHF Frequency Guide ..... £5.95
- Marine Frequency Guide ..... £4.95
- VHF/UHF Airband Guide ..... £3.50
- Comprehensive Airband Guide ..... £5.99
- Scanners II by P. Rouse ..... £7.95
- Scanners 3rd Edition ..... £8.95
- Flight Routings Guide 1990 ..... £4.95
- Monitoring the Iraq/Kuwait Conflict..... £3.95

## SCANNING ANTENNAS

- Nevada WB 1300 discone** (25-1300 MHz) Stainless steel top of the range 'N' type connector ..... £59.95
- CTE Micro Scan** (180-1300 MHz) New low cost ground plane ..... £12.00
- CTE Sky Band** (25-1300 MHz) Stainless Steel Discone (PL259 con.) . . . £24.00
- Nevada Mobile Antenna** (50-1300 MHz) Magnetic Mount ..... £27.90
- Create Wideband Beam** (105-1300 MHz) 20 Element ..... £89
- PA15 400-96MHz Collinear Base Ant.** (9dB at 900MHz) ..... £49

## ASA DIGITAL AIRBAND RADIO

This new low cost receiver is designed for aviation enthusiasts featuring a digital display for accurate reception and tuning. Coverage: 85-108MHz FM, 118-136MHz AM, 162-165MHz weather, 520kHz-1.6MHz ..... £59.95



## FAIRMATE

As the UK distributor for Fairmate we are constantly working with them to update and produce new features and models.

**FAIRMATE HP100E MKII** 1000 CH MEMORY Latest UK version. C/w all accessories. 8-600MHz, 800-1300MHz ..... £249

## FAIRMATE HP100E Special Model WB1

A new limited edition version with extended frequency coverage, includes 3 antennas and charging unit. 1-650MHz, 800-1300MHz.....£289

## UNIVERSAL SCANNER BASE UNIT PSU101 MKII

A mains operated unit which will both charge and power the handheld scanner. Complete with convenient desktop stand for use at home. Suitable for the following models:-

- Fairmate HP100E,
- Jupitar II,
- AOR 1000, £26.50
- ICOM IC-R1,
- Uniden BC 50XL,
- Uniden BC 55XL,
- Uniden BC 70XLT,
- Realistic PRO 38,
- Uniden 200 XLT,
- Uniden 100 XLT.

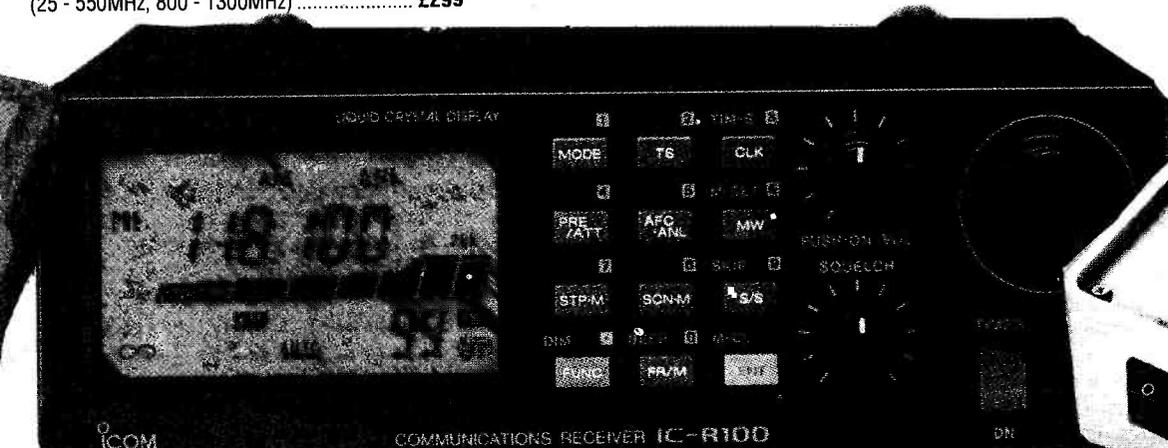
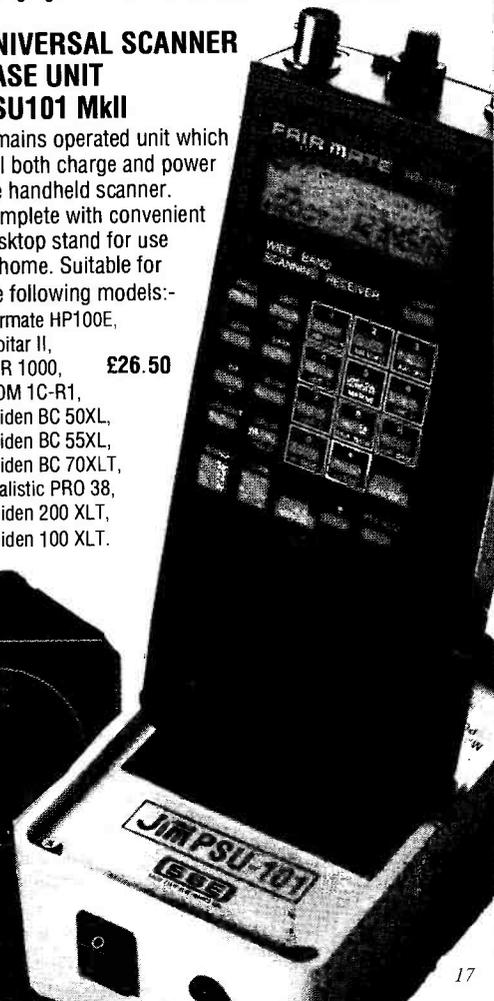

# SOLAR SWLING

Greg Baker

Living on even a small Australian farm has many joys for an s.w.l. and radio enthusiast. Forty hectares gives a lot of room for all manner of antennas and the local government authorities wouldn't know, or care, what antennas I erected. My Kenwood R-2000 is more than adequate, as a receiver, to pull in whatever wanders past the antennas, so it all sounds ideal.

However, I have one other thing to think about - providing my own electrical power.

This isn't unusual in Australia. Vast areas have no grid electricity and outback stations most often provide their own power. My problem is self-inflicted though.

The farm is far from the real outback. Forty hectares, 100km from Canberra and 300km from Sydney is hardly outback and the house is just 300m from an 11kV power line.

So the problem isn't the availability of power. It's the cost of connection to the grid - and I don't just mean in money terms either, although \$A6000 plus (say £2800) isn't cheap to get 240V a.c. to the house. What I am referring to is the environmental cost and loss of privacy that comes with the 20m swath clear of trees which accompanies all high voltage power lines in this part of the world.

Not feeling like having a house at the end of a wind tunnel, we opted to go it alone and put in a solar power system.

## Interesting Exercise

While I could have had a solar power company devise a system for me, I decided to work it out myself. It is an interesting exercise, first sizing a solar array and bank of storage cells, then installing it. It means also that whatever

**The most usual s.w.l. problem is with antennas and using them to pull in stations wherever they are. Greg Baker's problem is different - he has to provide his own power in the Australian bush.**

goes wrong at any time I am in a good position to know what the problem is and how to fix it. Of course, when you do it yourself there is no-one to blame either - but looking for scapegoats is a bit unproductive at the best of times.

We have two interconnected systems, one for the house and one for the outbuildings. The house system has to run, apart from the R-2000 and 27MHz CB transceiver, the lighting, television, cassette recorder and player, refrigerator, computer, disk drive and typewriter.

This system uses twelve BP Solar GL3641/12 photo-voltaic modules in two arrays of six each pointing, because it is the southern hemisphere, due north. Each module puts out 2.24A at 14V. This makes a total charging current of nearly 27A at 14V, though output voltage does vary with the state of charge of the bank of storage cells.

The charging current is regulated with an SCI-1 regulator made by Specialty Concepts Incorporated from California in the USA. The SCI-1 can regulate up to 30A at a nominal 12V into the lead-acid storage cells. From a discharged state, the regulator passes as much current to the storage bank as the arrays will provide. This continues until the storage bank has reached the full charge termination voltage of 14.8V, allowing gassing of the

cells at the end of each charge cycle. Thus the electrolytic is properly stirred to avoid stratification and the charge is equalised between individual cells. Stratification is the phenomenon of the electrolyte becoming more dense towards the bottom of the cells after long periods at float charge. This leads to a reduction in the capacity of the cells to store energy.

At the full charge voltage, the regulator switches to float mode which keeps the voltage to the float voltage of about 14.1V. Any system demands are provided from the excess current available above that needed to maintain this float voltage.

If the system demands more than is available from the solar array, the storage cells provide the difference. When the storage cell voltage falls to 12.5V, the regulator switches from float mode to full charging mode, replenishing the storage cells as the solar arrays and system allow.

The SCI-1 regulator sheds all load at about 11.5V for the bank, 1.9V per cell. This 1.9V means that the cell is more than 50% discharged, so we manually shed load if sunless days continue and the storage cells lose voltage. Some regulators can automatically shed load in step, but the SCI-1 does not.

## Storage Cells

The storage cells themselves are three parallel connected banks of six series connected 2V lead-acid cells. Each cell has a capacity of 225Ah hours at 2V, each series connected bank therefore stores 225Ah hours at 12V and the three banks together store 675Ah at 12V.

This arrangement into 2V cells gives great flexibility, allowing tapings to be made at 6V for the cassette player, typewriter and disk drive, 8 volts nominal (but nearer 9V) for another cassette player and computer and, of course, 12V for other devices like the R-2000.

The cells are Century PG227 cells, each of 190 x 160 x 270mm in size, contain 2.9 litres of electrolyte and have a mass of 15kg. They are provided with heavy lead interconnecting rods or optionally with large diameter, flexible, insulated leads. The size of these links keeps resistance losses to a minimum, though regular attention is needed to make sure the joints are free from corrosion.

The cells are in transparent polystyrene cases which makes it easy to check the electrolyte level. In addition, they have a built-in hydrometer consisting of three balls of different densities and colours. Each white ball falls to the bottom of its cage at 10% discharge, each green ball falls at 50% discharge and each red ball at 100% discharge. Though the cells are deep cycle types, their life can be



# SOLAR SWLING

prolonged further by reducing the depth of discharge in each discharge-charge cycle. The maximum discharge shouldn't exceed 50% more than once or twice a year which is why we manually shed load as overcast days continue.

## Reserve

The other system has three photo-voltaic modules made in Australia by Solarex. One is a square X100 module, the other two rectangular X100GT modules. They put out 2.1 and 2.4A at the nominal 14V for X100 and X100GT modules respectively. This makes a total charging current of 6.9A through a basic Solarex shunt regulator into one bank of six series connected Century PG227 2V cells. This system is used for outbuilding lighting and as a reserve for the main system.

The two systems can be connected to one another via a pair of 12mm<sup>2</sup> insulated copper cables running the 40m between the outbuilding system and the house and buried underground in 20mm black polyethylene water pipe.

The house and outbuildings we've wired ourselves with colour coded wire pairs connected from two 12 sq mm wires as house bus bar. The smaller wires are 4 sq mm. Thus voltage drop

from the storage cells to the R-2000 is kept to less than 0.2V. The R-2000 starts to object when voltage drops much below 12V so line savings are crucial over the 15m of wire from the storage cells.

House requirements are low and the system can operate for more than six days without sun. However, we start shedding unimportant load before then. The cassette player and computer go first and we're more careful with lighting than usual for those who provide their own power.

Next goes the R-2000 because I'm out-voted when I try to claim that it is essential. Short wave listening just has to wait until the sun re-emerges. The television is next, barring the nightly ABC news broadcast, a necessity when daily newspapers are a twenty minute drive away. Finally, the refrigerator goes and we swap over to a paraffin powered back-up. The lighting would be last, but it's never come to that.

## QRM

The main s.w.l. headache with the system, apart from losing it all together if overcast weather continues, has been with interference from the direct current devices we've installed.

The 12V, 20W fluorescent lights are the worst offenders. They are run from small, in-built, solid-state inverters that not only push r.f. energy back down the power line and radiate from it, they radiate r.f. themselves. An r.f. choke stops the power line acting as a radiator, but not the direct radiation from the inverter circuitry. While we could install a Faraday screen around all light fittings, we're not too keen on looking like a prison or railway station.

The one fluorescent fitting without an r.f. choke, located in a storage shed 35m away, radiates strongly enough to make the R-2000 quite unusable when that light is on. Fortunately, some fluorescent inverters are better than others so we've re-arranged the best to where we spend the evenings, my XYL reading while I write and tune around.

Maintenance is confined to regular checking of electrolyte and topping up when necessary, checking leads and connections and adjusting the solar arrays up and down through the year to catch maximum sunlight.

And with all that there is still a pleasure in being in charge of the whole system: power, radio and antenna. All I need is a few radio signals to complete the picture. But that's all taken care of.

**HAVING DIFFICULTY GETTING YOUR COPY OF SHORT WAVE MAGAZINE ?**

**Then place a regular order with your newsagent**

**OR WHY NOT TAKE OUT A SUBSCRIPTION AND SAVE MONEY**

**SUBSCRIPTIONS TO SWM**

Please indicate the type of subscription required:

### SHORT WAVE MAGAZINE 1 YEAR

- £19.00 (UK)
- £21.00 (Europe)
- £22.00 (Rest of World)

### PRACTICAL WIRELESS 1YEAR

- £19.00(UK)
- £21.00 (Europe)
- £22.00(Rest of World)

### SPECIAL JOINT SUBSCRIPTION 1 YEAR ONLY

- £32.00 (UK)
- £35.00 (Europe)
- £37.00 (Rest of World)

Prices current at October 1990

Subscription to commence with issue dated.....

To: PW Publishing Ltd., FREEPOST, Subscriptions Dept., Enefco House, The Quay, Poole, Dorset BH15 1PP

Name.....

Address.....

I enclose cheque/PO (Payable to PW Publishing Ltd) £.....

Charge to my Access/Visa Card the amount of £.....

Card No.

Valid from ..... to .....

Signature.....



VISA

Credit Card Orders can be taken on (0202) 665524.

# HF RADIO WAVE PROPAGATION

F. C. Judd G2BCX Part 3

We now deal with the longest, but rarely attainable, single propagation path (longest possible 'skip' distance), some more anomalous modes such as scatter and back-scatter, auroral curtain reflection and ground, or surface wave, propagation.

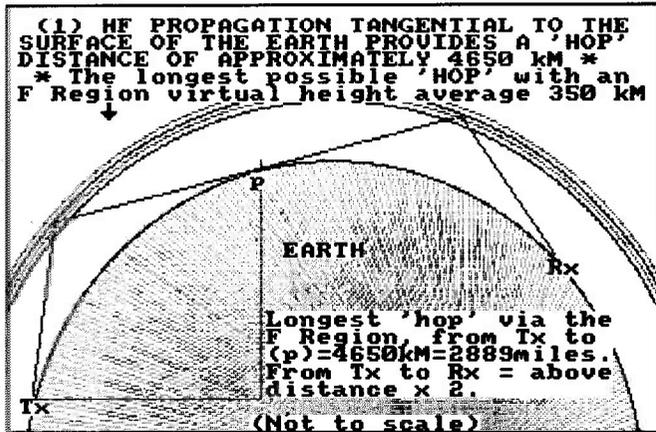

(1) The annotation explains how the longest single 'hop' (earth - F region - earth) is obtained. This is only possible if the angle of maximum vertical radiation from the transmitting antenna is zero and the wave, therefore, takes a path 'tangential' to the surface of the earth to meet the F region as shown here.

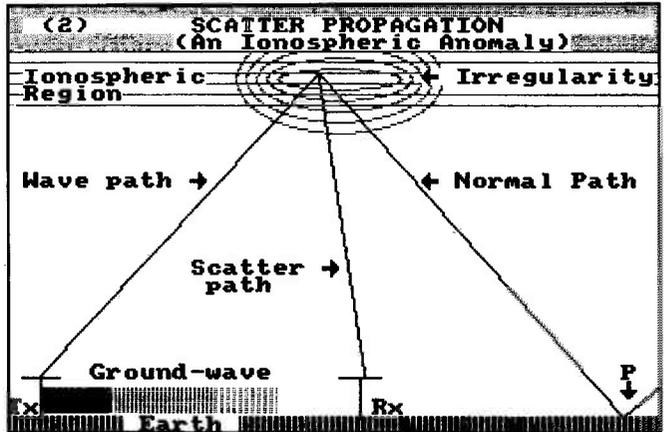

(2) Scatter propagation can occur in various ways and one is due to the occurrence of irregularity in an ionised region. A forward wave is refracted in the normal way but a patch of irregular ionisation can also refract the same wave at the same time, along a steeper, but still forward, path. Signals propagated this way are usually not very strong.

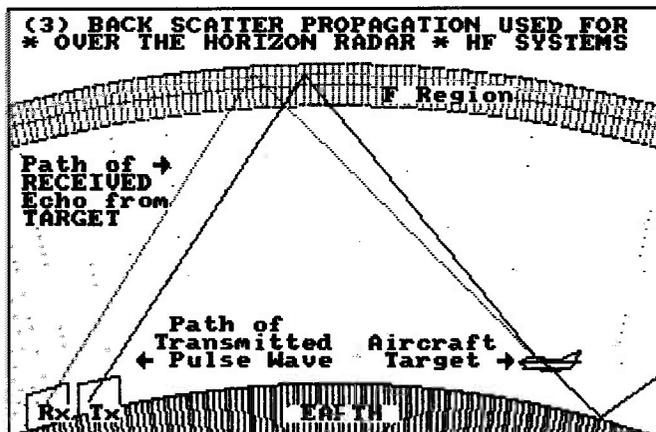

(3) In which 'scatter' propagation via the F region is used to advantage. This is the 'back scatter' mode employed by the US Defense Department for the detection of high or low flying aircraft, or guided missiles, at very long ranges, known as 'over the horizon radar (OTHR)'. (*Practical Wireless* August 83). An h.f. spectrum 'surface radar' system (this makes no use of the ionosphere) is now in operation in the UK.

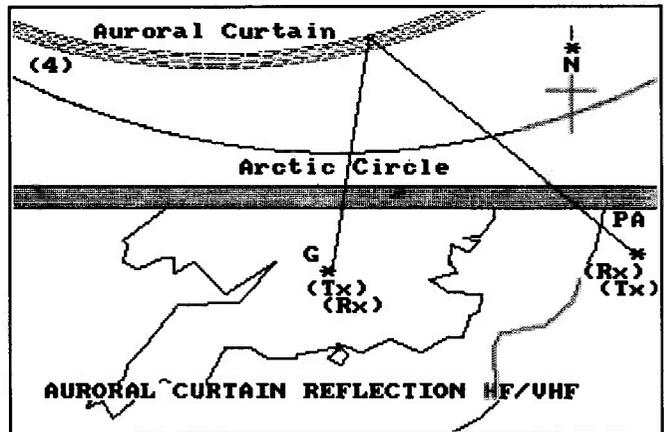

(4) The 'Auroral Curtains' that form at the extremes of the Northern and Southern hemispheres can become ionised in the same way as an ionospheric region and can, therefore, reflect radio waves at both h.f. and v.h.f. An actual v.h.f. path is shown here which allowed a two-way radio contact to be carried out between central England (G) and Holland (PA).

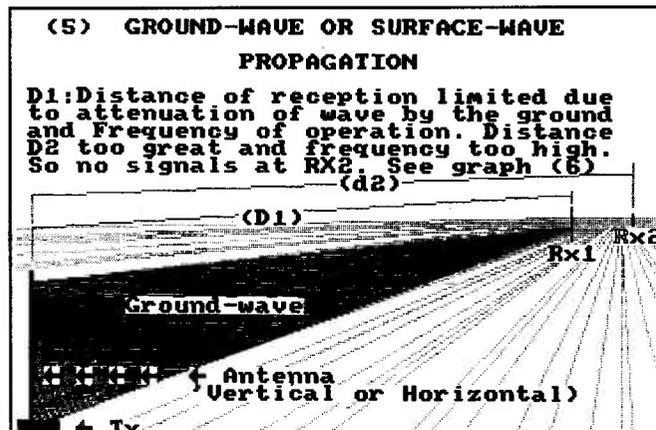

(5) Ground wave propagation is normally only used by amateurs on their allocated h.f. bands and by CB operators at 27MHz for short range operation. Above about 2MHz, ground attenuation becomes greater with increasing frequency. Beyond about 30MHz is the v.h.f. spectrum where the conditions governing propagation are quite different.

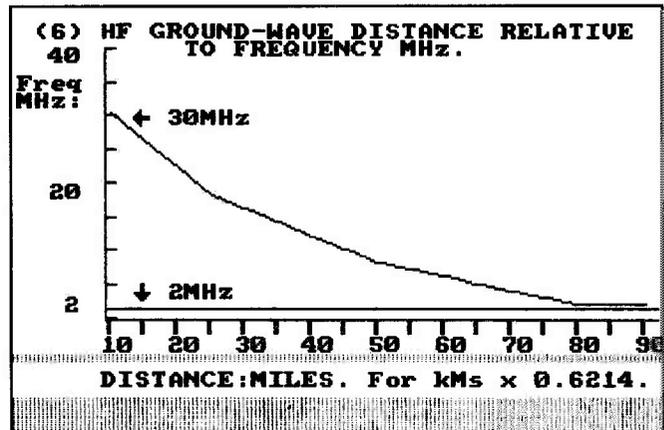

(6) Approximate 'ground wave' propagation distance versus frequency of operation up to 30MHz. Note that at 2MHz the curve flattens out at about 80km. At lower frequencies (medium wave band) the distance may not extend to much more than 100km although this increases as the frequencies become lower still (long wave band).

# IF YOU ARE THINKING OF BUYING A NEW SCANNER...

MAKE SURE YOU RING US FIRST FOR THE BEST DEAL

FAIRMATE HP100 .....£?  
JUPITER .....£?

AOR1000 .....£?  
BEARCAT .....£?

Part Exchange Welcome...Part Exchange Welcome...Part Exchange Welcome...Part Exchange Welcome

## AIR PRO II

PROFESSIONAL AIRBAND RECEIVER  
WITH DIGITAL FREQUENCY DISPLAY  
FULL VHF AIRBAND

AIRPRO II DESIGNED FOR PILOTS  
AND RADIO ENTHUSIASTS.

The first reasonably priced digital handheld receiver. Features AM/FM/Air Bands and comes complete with rubber and retractable antennas, belt clip and a set of batteries plus 12 months guarantee.

NOW IS THE TIME TO UPDATE YOUR OLD AIR  
BAND RADIO? (for a real performance receiver)  
SPECIFICATIONS:

<b>GENERAL</b>	
Bands .....	4
Input Voltage .....	12V DC
Audio Power .....	
Output .....	170mW
Physical Height .....	210mm
Width .....	82mm
Depth .....	61mm
Weight .....	0.5kg
Current Drain .....	
Receiver .....	100mA
Display .....	70mA

### RECEIVER

	<b>AM</b>	<b>FM</b>
Sensitivity	(20dB SINAD) 4.7mV/m	(30dB SINAD) 4µV
Frequency Range	520-1650kHz	88-108MHz
Selectivity	10dB	25dB
Image Rejection	25dB	20dB

	<b>AVIATION</b>	<b>WEATHER</b>
Sensitivity	(30dB SINAD) 4.1µV	(30dB SINAD) 5.3µV
Frequency Range	118-136MHz	162.5MHz
Selectivity	40dB	10dB
Image Rejection	25dB	30dB

**£59.95** PLUS £3.00 P&P

## S.R.P. TRADING

Manufacturers and distributors of communications equipment  
Unit 20, Nash Works, Forge Lane, Belbroughton,  
Nr Stourbridge, Worcestershire.

Telephone: (0562) 730672 Fax: (0562) 731002  
Open Mon-Fri. 9-5am. Sat 9-1am.

## SKY SCAN DX-DISCONE 25 to 1300MHz

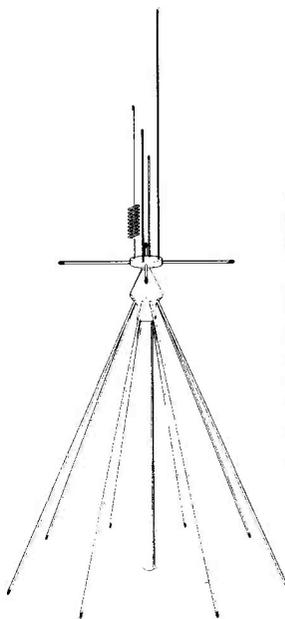

Most discones only have horizontal elements and this is the reason that they are not ideal for use with a scanner. Most of the transmissions that you are likely to receive on your scanner are transmitted from vertically polarised antennas. The Sky Scan V1300 discone has both vertical and horizontal elements for maximum reception. The V1300 is constructed from best quality stainless steel and aluminium and comes complete with mounting pole. Designed and built for use with scanners.

**£49.95**  
+ £3.00 p&p.

## SKY SCAN MAGMOUNT

For improved performance, wide band reception, 25 to 1300MHz. Comes complete with protective rubber base, 4m RG.58 coax cable and B.N.C. connector. Built and designed for use with scanners.

**£19.95**  
+ £3.00 p&p.

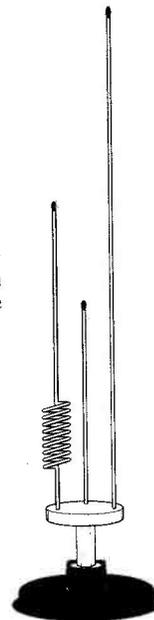

### SKY SCAN - DX DISCONE

VHF 50-107 MHz	AIR 108-136 MHz	VHF-H 137-175 MHz	UHF 176-525 MHz
----------------------	-----------------------	-------------------------	-----------------------

526-1300MHz CELLULAR PHONES

Name .....  
Address .....  
.....  
.....

Cheque P/O .....



Visa/Access No.

Expiry Date .....

Signature: .....

# ASK ELECTRONICS LTD

248-250 TOTTENHAM COURT ROAD  
LONDON W1P 9AD

TEL: 071-637 0590/071-637 0353 TELEX: 27768  
FAX: 071-637 2690



## PHILIPS

### D 1875

- Compact 12-Band Portable Radio • LW/MW/FM/9 short wave • Large tuning control • Tuning LED indicator • Telescopic and ferroceptor aerials • DC supply connection • Earphone connection • Wrist strap • Attractive pouch

**£49.95**

ALSO IN STOCK  
PHILIPS D1836  
SAME AS D1875  
ONLY

**£39.95**

### D 2345

- Portable Radio • LW/MW/FM/2 x SW • Fine Tuning Control • Mains/battery supply

**£24.95**

**WE ALSO STOCK A WIDE RANGE OF  
MULTI STANDARD TV'S AND VIDEOS**



**£119.95**

### D 2935

- All electrical Digital World Receiver • LW/MW/FM/13 x SW • Continuous tuning over total AM band • Direct keyboard tuning • 9 station memory • Variable pitch BFO for CW/SSB reception • Touch panel switching • LCD frequency display • Mains/battery supply

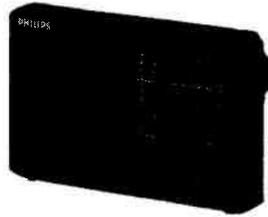

### ICF 2001D

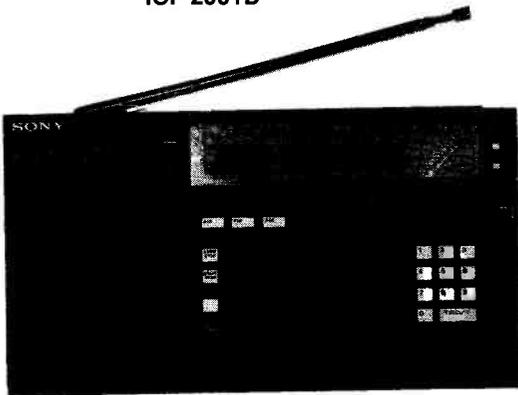

## SONY

### FINEST ALL-ROUND PRO-RECEIVER IN THE BUSINESS

- FM/LW/MW/AIR multi-band reception • 32 station preset memory • Synchronous Detector Circuit • PLL quartz-locked synthesizer circuit • Digital/analog tuning • 2-way scan modes (auto stop, 1.5 sec. hold) • 2-position AM selectivity • AM RF-gain control • 3-way scan tuning (memory, broadcast, define) • 3-position tone control • Direct meter band access • 4-event programmable timer • AM attenuator • SSB reception • External antenna for AM, FM and AIR band • 288x159x52mm (w/h/d) • 1.7kg.

2001D SYSTEM - ICF-2001D with active antenna AN-1 in one complete package.  
**\* £319.95\***



### ICF 7600DS

- PLL synthesized multiband digital radio • 4 - way tuning • Direct frequency LCD read out • 10 memory presets • 10 key auto and manual scan • Full continuous waveband coverage 153-29995kHz; FM76 - 108MHz • Single side band and fine tune controls • Tone control • External aerial socket • Record out socket • 12/24 hour LCD clock • 65-minute sleep timer • Supplied with waveband manual, case and wrist strap

**\*£139.95\***

ICF SW1E **£145.00**

ICF SW1S KIT **£199.95**

ICF SW1E AND CONVENIENT SUPPLIED ACCESSORIES: ACTIVE AERIALS, AUTOMATIC MULTIVOLTAGE MAINS ADAPTOR, HARD CARRYING CASE  
**THE WORLD'S SMALLEST SHORTWAVE RADIO**

- FM stereo MW/LW/SW PLL synthesized tuner • Dual conversion system • LCD frequency read out • Multiple tuning system • 10 key/scan/memory • 10 memory presets • Cassette size case • Clock/timer facility • Supplied with stereo headphones, compact antenna

ALSO IN STOCK THE NEW \*SONY ICF-7600 SW\*  
**\*£149.95\***

### WA 8800



### SLIM STYLED TRAVELLERS SHORTWAVE MULTIBAND AND STEREO CASSETTE RECORDER

- FM/MW/SW x 8.0 band • Dual conversion circuit (SW) • Auto reverse stereo cassette deck • LCD clock/alarm/timer/60 minute sleep timer • Tape counter • Auto shut off • Stereo recording facility • Built-in Stereo speaker • Stereo mic supplied • DC in socket • Black finish

**\*£199.95\***

### NEW ARRIVAL:- SONY CRF-V21

- FAX/RTTY/Satellite/Weather FAX • Frequency range 9kHz - 29.9999MHz • Sat. 137.62 - 141.12MHz • Up to 1.691GHz/1.6945GHz using ANP1200 (optional antenna) FM-76MHz - 108MHz

**P.O.A.**

### Panasonic RF - 9000

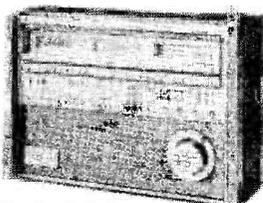

FM 87.5-108MHz  
LW/MW/SW (1.6110-2.9003MHz)  
SW (2.9010-30.0000MHz)  
Frequency Range: LW 150.0-420.0kHz  
(2000-714.3m) MW 520.0-1610.9kHz  
(576.9- 186.2m) SW 1.6110-  
2.9009MHz (186.2 - 103.4m)  
Precision: Direct Readout to 100Hz for  
SSB/CW/AM. Direct Readout to 10kHz for FM

**£1800.00**

Panasonic RF-B10 .....	<b>£59.95</b>
Panasonic FR-B20L .....	<b>£69.95</b>
Panasonic RF-B40DL .....	<b>£124.95</b>
Panasonic RF-B65 (inc Mains adaptor) .....	<b>£169.95</b>
Sony ICF SW20 .....	<b>£64.95</b>
Sony ICF PRO 80 .....	<b>£289.95</b>
Sony ICF AIR-7 .....	<b>£209.95</b>
Sony AN 1 (Antenna) .....	<b>£49.95</b>

**ALL MAJOR CREDIT CARDS ACCEPTED ALSO CHEQUES AND  
POSTAL ORDERS**

**ALL SETS ARE GUARANTEED  
PRICES INCLUDE V.A.T.**

**ALL GOODS DESPATCHED WITHIN 48 HOURS**



# SCANNING

Alan Gardener

## Product News

Tandy have three new products featured in the scanning receiver section of their 1991 catalogue. The first of these is the top-of-the-range PRO-2006, which I briefly mentioned in the August 1990 column.

The new model is basically the same as the PRO-2005 it is replacing, with a couple of modifications. These bring the scanning speed up to either 13 or 26 channels per second, which is double the rate of the PRO-2005. On top of that an additional 100 memory channels are provided, making a total of 400 in all, arranged in 10 banks of 40. All the other facilities remain the same - except the price which is now £349.

The next new scanner is the Patrolman PRO-2025. Retailing at £99 this is

This month the column is shorter than usual as the scanning enthusiast has *What Scanner*. However, Alan takes a look at a new range of products from Tandy.

etc., and as such should be useful as a cheap scanner which could be permanently fitted in a car or used as a watch receiver in a boat.

The final new item is a wide-band, magnetically mounted, mobile antenna. This consists of a short vertical whip section with two loading coils mounted at approximately one and two thirds of the way up. The antenna is supplied with 4m of cable which is terminated in a

kits, each one costing around £5. More details can be obtained by sending an s.s.a.e. to: P Beckett, 3 Pasture Close, Whitmore, Staffs ST5 5DQ.

## Other Goodies

Looking through the rest of the catalogue there are a host of items which will be of interest to scanner users including extension speakers, 12V mains power supplies, plugs, sockets, adaptors, antennas, etc. One item which several readers have recommended is a CD cassette adaptor. This looks like a normal compact audio cassette with a short lead running from it.

The intended purpose of the unit is to allow a portable CD player to be connected into the car cassette player, without having to perform any modifications. The adaptor lead plugs into the headphone socket of the CD player and the adaptor fits into the car in place of a normal cassette. This magnetically couples the audio signal from the CD player into the car stereo allowing high quality reproduction of CDs.

The adaptor can also be used with other equipment - hand-held scanners for example. Just plug the scanner into the adaptor, keep the scanner volume control low and set the listening level on the car cassette. It is a good idea to turn the treble up and bass down with the tone controls or graphic equaliser as this can make a big improvement to the intelligibility in noisy vehicles. One final point is to check if your cassette player is front or side loading as some types are not suitable, so ask before buying.

If you have any questions you would like to ask or any tips to pass on, why not drop me a line at PO Box 1000, Eastleigh, Hants SO5 5HB. Until next month - Good Listening. □

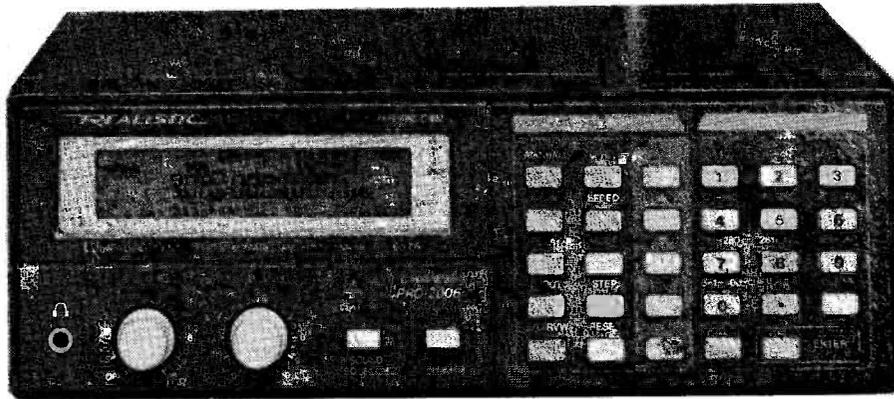

intended to be a low-cost, 16-channel scanner designed specifically for mobile use. The name 'Patrolman' gives a clue to the purpose the model is being sold for in America, but I am sure that it will find a range of other uses this side of the Atlantic. Being primarily designed for the American market it is only capable of receiving n.b.f.m. transmissions. It covers the frequency bands 66-88, 136-174 and 406-512MHz, which are suitable for use in most European countries.

In order to keep production costs down, the method of frequency entry and display is similar to that used on the PRO-38 hand-held, with each digit appearing in sequence. Whilst this does not make the scanner suitable for searching frequency bands it is ideal for monitoring known local frequencies such as amateur repeaters, marine channels,

Motorola-type car radio connector, an adaptor to convert this to a common BNC connector is also available for £2.29 if required. The price of the antenna is £29.95.

Incidentally if you want to upgrade your PRO-2005 to the same level of performance as the new 2006, then P. Beckett is offering a range of modification



The new Realistic Patrolman PRO-2025 16-channel programmable scanner.

**RADIO LINE**

THE UP-TO-DATE NEWS & INFORMATION SERVICE FOR  
THE LISTENING ENTHUSIAST

**0898 654676**  
UPDATED EVERY SATURDAY

**RADIO LINE**

Calls charged at 33p per minute cheap rate,  
44p per minute at all other times.

# Waters & Stanton

0702 206835

or 204965

**BEST PRICES! FAST MAIL ORDER**

## Just Published!

SEVENTH EDITION

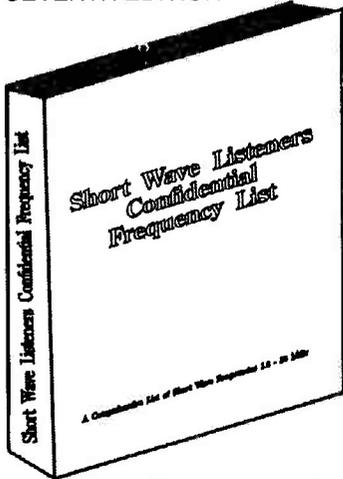

Order by Phone  
0702 206835

Short Wave  
Listener's  
Confidential  
Frequency List

**£8.95**

Post &  
Packing  
**£1**

- Best times for UK reception
- Military & Civil Air channels
- Marine Channel numbers
- Military Ground & Sea listings
- Broadcast & Press listings
- AM SSB CW RTTY SITOP FAX
- Every entry reviewed or updated
- 200 Pages packed with information
- Numerical Frequency listings
- Block designations of primary users
- Station location and modes

**New!**

### AR- 1000 Hand Scanner

The AR- 1000 is the latest version of the "Fairmate" but with a few extras. 8- 1300MHz AM/FM/WFM

You get the AC Mains supply, an extended frequency coverage down to 8MHz, and UK programmed bans. The receiver has been specially produced for the UK and European band plans and makes for easier operation. Of course you still get your 1000 memories and all the extras such as case, DC lead, aerial, etc. You also get the advantage of our after sales service!

**Our Price £245**

Add £3 Post & Insurance



**New!**

### ICOM R1 "Micro" Scanner

150kHz- 1300MHz! The radio Spectrum in your palm, includes 100 memories, 11 search steps, AM/FM, Wide FM, Clock Timer, S-Meter, Power Save, Rotary Channel Control, and much more. We now have the latest version in stock shipped in July.

**Our Price £389**

Add £3 Post & Insurance



### BUYING A RECEIVER?

We have comprehensive stocks of all the latest models and some of the most experienced staff in the business. Add to this some really super prices and you will realise why so many customers purchase their equipment from us. *P.S. We also have excellent service facilities!*

#### KENWOOD R2000

150kHz - 30MHz  
SSB-CW-AM-FM  
10 Memories VHF Option



#### KENWOOD R5000

100kHz - 30MHz  
SSB-CW-AM-FM-FSK  
10 Memories  
VHF Option



#### SONY ICF 2001D

150kHz - 30MHz +  
Airband  
SSB-CW-AM  
32 Memories Mains/Batt



#### ICOM R7000

25MHz - 2GHz!  
SSB-CW-AM-FM  
99 Memories Many  
Options



### JUPITER 25— 1300MHz

Simply the "BEST"  
The Most Logical  
The Most Sensitive  
The Most "Widely Used"

MVT 5000 (New Price)  
Now includes Ni-cads, case  
and 12V charge lead.

#### General Features

- Switchable AM/FM
- 25-550MHz & 800- 1300MHz
- Proper manual up/down electronic tuning
- 100 memories in 5 banks of 20
- Selective bank scanning
- 10 programmable band segments
- Priority channel
- Any memory channel can be temporarily passed
- Steps of 5, 10, 12.5, 25 or 30kHz
- Auto frequency correction for step changes
- Band Search or memory Scan
- Carrier or audio locking
- Permanent/temporary hold
- Delay
- Slow/Fast speed (20 steps per second)
- Battery saver circuit
- Large speaker for good audio
- BNC Socket
- Proper English manual for UK market
- Not an American import
- Key lock
- Telescopic antenna

INCLUDES  
AC PSU

MVT 6000 BASE/MOBILE



FREE DELIVERY ON ALL JUPITERS

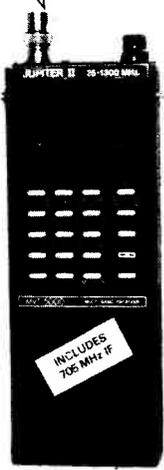

### NEW INSTANT "HP" BY MAIL ORDER

If you are unable to travel to us we can now offer excellent credit facilities by mail order. Simply write or telephone for application form and subject to acceptance, you will receive a "Waters & Stanton" instant credit card. After that you need only telephone your order for immediate despatch. Initial purchase is subject to 10% minimum deposit. From then on your repayments are flexible to suit your own pocket. And should you go into credit, then you will receive interest! Send for full details. Large SAE please.

Retail and Mail Order:  
Retail Only:

18-20, Main Road, Hockley, Essex SS5 4QS. Tel: (0702) 206835/204965  
12 North Street, Hornchurch, Essex. Tel: (04024) 44765

VISA & ACCESS MAIL ORDER. 24 Hour Answerphone. open 6 Days a Week 9am-5.30pm  
Rail: Liverpool St./Hockley or District Line/Hornchurch

**ALL MAJOR BRANDS STOCKED LARGEST IN SOUTH EAST**

KENWOOD YAESU ICOM JAYBEAM AZDEN MIZUHO REVEX JUPITER ALINCO

SAGANT ADONIS SONY PANASONIC DATONG TONNA DIAMOND PAKRATT AOR ERA

# BOOKCASE

## **DSWCI TROPICAL BANDS SURVEY 18th Edition 1990**

**Edited by Hans van den Boogert  
Danish Short Wave Clubs International  
ISSN 0100-1968**

**36 pages, 7 IRCs or 30 Danish Crowns by post, 9 IRCs  
or 35 Danish Crowns by Airmail**

**Available from DSWCI, c/o Bent Nielsen, Betty  
Nansens Allé 49, 1 tv, DK-2000 Frederiksberg,  
Denmark.**

In this A4, offset-printed booklet you will find all the active broadcast stations in the 2 to 5.9MHz frequency range, listed by frequency with their power and transmission times.

It is completely updated and is based upon monitoring information from DXers all over the world, including 'special envoys' to rarely visited countries in Latin America, Africa and Asia. Each station is classified by a code, which tells the reader how often the station has been reported since May 1989 world-wide and in Europe. The survey is double-spaced for ease of updating.

## **RECEIVER SHOPPING LIST Edition 12 July 1990**

**Radio Nederland Wereldomroep**

**56 pages, sent free of charge**

**Available from Radio Nederland, Box 222, 1200 JG  
Hilversum, The Netherlands.**

Two years ago, Radio Nederland published the previous edition of this list. At the start of 1989 they stopped sending it out because there were so many changes in the market place that the information contained in it was no longer current.

The new editions includes price checks made in the UK, Canada, Holland, USA, Japan, South Africa, New Zealand and Australia. Other chapters are 'Choosing a Receiver', 'Current Receiver Survey', 'Recently Discontinued Receivers', 'SW Equipment Sources', 'Military Surplus Receivers', 'Vintage Wireless Societies', 'Selected Reference Books', 'Service Sheet Sources' and 'Receiver Information Sources'.

## **PRACTICAL GUIDE TO PACKET OPERATION IN THE UK**

**Mike Mansfield G6AWD**

**68 pages, £6.00**

**Available from SWM Book Service, 85p post and packing**

Increased opportunities present themselves to the amateur radio world every so often. Some are welcome, others aren't. Packet radio appears to fall into both camps depending on your point of view, in fact it seems to have split the amateur world like no other mode!

This book aims to demonstrate the clear concepts of packet radio to the beginner. The warts and the highs of the system are clearly laid out. Problem areas are discussed and suggestions are made for solutions - or at least minimise the problems.

There are two parts to the book. The first section introduces the technical aspects of packet radio and takes the reader through the setting up and understanding of the settings that may be adjusted.

The second, and possibly more useful, section provides a comprehensive guide to all common reference material required whilst operating a packet station.

## **MORE ADVANCED TEST EQUIPMENT**

**CONSTRUCTION BP249**

**R.A. Penfold**

**Bernard Babani (publishing) Ltd ISBN 0-85934-194-1**

**102 pages, £3.50**

**Available from the SWM Book Service, 85p post and packing**

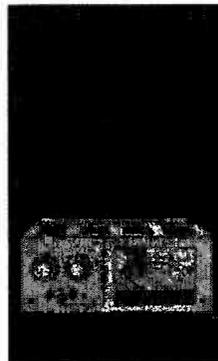

This book carries on from BP248, describing some slightly more advanced projects for readers who have a certain amount of experience at project construction. Full circuit diagrams, plus notes on construction, are provided. Detailed notes on any necessary setting up are also provided, together with information on using the projects to good effect.

In the book you will find - a digital voltmeter, a.f. digital meter, digital capacitance meter, digital resistance meter, digital transistor tester, digital current tracer, digital heat-sink thermometer, crystal calibrator, bench power supply, pulse generator and a dynamic transistor tester.

These projects provide the constructor with a very useful range of test equipment for project servicing and development. Although the projects are not really suitable for complete beginners, anyone having even a modicum of practical electronics construction experience should have little difficulty in building them.

## **TEST EQUIPMENT CONSTRUCTION BP248**

**R.A. Penfold**

**Bernard Babani (publishing) Ltd ISBN 0-85934-193-3**

**104 pages, £2.95**

**Available from SWM Book Service, 85p post & packing**

This book describes in detail how to construct some simple and inexpensive, but extremely useful, pieces of test equipment. Stripboard layouts are provided for all designs, together with wiring diagrams where appropriate, plus notes on their construction and use.

The test equipment you will find includes an a.f. generator, capacitance meter, test bench amplifier, a.f. meter, audio millivoltmeter, analogue probe, high resistance voltmeter, c.m.o.s. probe, transistor tester and a t.t.l. probe.

Apart from providing the home constructor with a useful range of test gear, building these projects should also be an interesting and rewarding exercise in its own right. The designs are suitable for both newcomer and more experienced hobbyist alike.

# A MEDIUM WAVE AM RADIO

R.G. Evans BSc G4XAT

This effective circuit uses the ZN416E a.m. radio i.c. from Ferranti. The i.c. is similar to an earlier device, the ZN414, but incorporates a built-in audio amplifier. It was designed to operate two 32Ω earpieces (*à la* Walkman) but produces more than adequate volume from a single 64Ω loudspeaker if required.

## Circuit Operation

Referring to the circuit diagram, **Fig. 1**, L1 and C2 form a tuned circuit whose resonant frequency can be varied from about 600kHz to 1.6MHz. A voltage is induced in L1 from the radio signal transmitted from a radio station, the electromagnetic waves being 'collected' by the ferrite rod antenna.

This voltage is amplified, limited by the automatic gain control circuitry and detected, i.e. the audio information recovered from the radio signal, by the first stage of the ZN416. The recovered audio signal first is amplified by a buffer stage before being fed to the headphones. All of this is done by the ZN416E i.c. and all on 1.5V!

## Components

For adequate results a reasonable sized ferrite rod must be used, although small rods with many turns of wire could be used. The variable capacitor (C2) is a miniature a.m./f.m. tuning type, but you could use one taken from a cheap transistor radio if you wanted to.

No volume control is used, nor is one necessary. Ferrite rod antennas are directional, a property you can use to null out an interfering station (especially at night) or to reduce the volume of a desired station (unlikely).

Some buildings have a steel framework which will cause considerable screening of m.w. signals. If you can't tune in to anything, take the radio outside. Do not expect to be amazed by the quality, m.w. a.m. is inferior to v.h.f. f.m., but there is nothing quite like building your first radio!

## Construction

The complete radio, with the exception of the ferrite rod antenna, the headphones and the battery, is built onto a simple p.c.b. as shown in **Fig. 2**.

The printed circuit board was designed to provide enough room with solid mounting for all the parts. More compact designs are possible but, as usual, there is a compromise.

Solder the fixed capacitors in place first, followed by the tuning capacitor with the i.c. next. The switch is the last component to be fitted.

Check all your work carefully for dry

This medium wave receiver is simple and cheap to build - what's more, it will give you the satisfaction of knowing that you have done it all yourself.

joins and solder whiskers. If all appears to be alright you can connect up the battery - making sure that it is the correct way round of course! Switch on and you should be able to tune in several stations.

The p.c.b. is available from the SWM PCB Service and a number of kits, not including headphones and battery, will be available from the same source at £11 inclusive of VAT and postage. □

## YOU WILL NEED

### Capacitors

10nF	2	C1, 5
100nF	1	C3
470nF	1	C4
0-126pF	1	C2 (Maplin FT78K)

### Inductors

60 - 80 turns	1	L1
(30s.w.g. e.c.w. wound on ferrite rod.)		

### Integrated Circuits

ZN416E	1	IC1 (Electromail 630-550)
--------	---	---------------------------

### Miscellaneous

Switch s.p.d.t. S1 (Electromail 664-200), 64Ω headphones, LS1; AA cell and holder, printed circuit board, Ferrite rod (Circuit 35-14757)

Fig. 1.

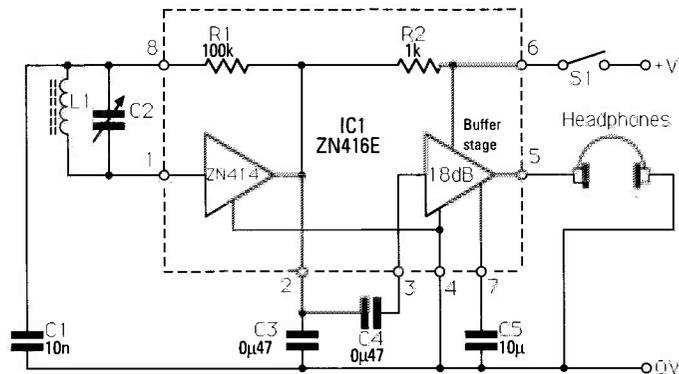
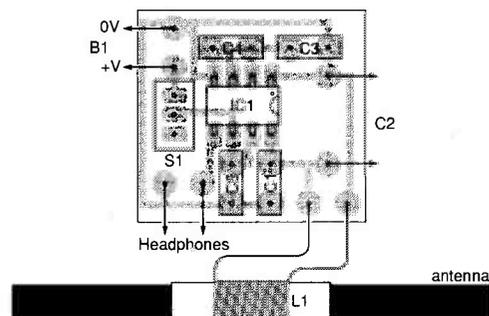
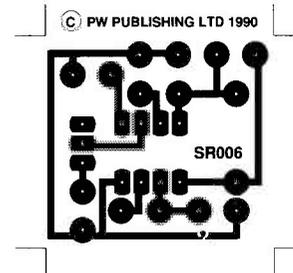

Fig. 2: Full-size p.c.b. track plan and component placement drawing.



# RAYCOM BRINGS YOU THE LATEST TECHNOLOGY - FIRST!

SALES HOTLINE 021 552 0073 and HELPLINE 021 552 0051 (Office Hours)  
 FULL RANGE OF ICOM, YAESU, BEARCAT, NAVICO, MFJ AND MANY MORE

The **TOKYO HX240** HF Transverter when coupled to an all-mode 2m rig will give you 50 watts on 80 to 10m. RAYCOM have put together this unique unit with the new YAESU FT290RII inc. DC and COAX leads!!!



**SPECIAL THIS MONTH ONLY!!!**  
**HX 240 - £229**

- FT290R II ..... £429.00
- TOKYO HX240 ..... £249.00
- 1/2 Size G5RV ..... £ 14.95
- 12 Amp PSU ..... £ 59.95
- Nicads & Wall Charger ..... £ 31.30
- Total regular price ..... £784.20**

**RAYCOM PACKAGE DEAL £699.00**

**YOU SAVE £85.20!!**

## THE UK SCANNER EXPERTS

### LATEST NEWS FROM ICOM! WE HAVE THE SCANNER!!!

Demand for the new IC-R1 handheld and the IC-R100 base/mobile scanning receiver is extremely high, with the result that supplies have been sporadic. We are the only dealer in the UK to have consistent supplies of the IC-R1/R100. **RAYCOM's buying power wins!**

- IC-R1 500kHz to 1300MHz.....£399.00
- IC-R100 500kHz to 1800MHz.....£499.00

**Ring our hotline now to order your R1 or R100!**  
**Buy it now! e.g. R1 £40 deposit, payments £15/month (APR 36%)**

### OTHER HIGH QUALITY SCANNERS FROM RAYCOM

- BEARCAT UBC 50/55XL 66-88/136-174/406-512MHz ..... £99.95  
 10 memories, channel review, including **FREE** charger worth £4.95
- BEARCAT BC 70XLT 66-88/136-174/406-512MHz ..... £149.99  
 20 memories, full frequency display, with **FREE** car charger kit worth £4.50
- BEARCAT UBC 100XLT 66-88/118-174/406-512MHz ..... £199.99  
 100 memories, airband, search, including **FREE** car charger kit worth £4.50
- BEARCAT UBC 200XLT 66-88/118-174/406-512/806-956MHz ..... £229.99  
 200 memories, top of the range including **FREE** car charger kit worth £4.50
- BEARCAT UBC760XLT 66-88/108-174/350-512/806-956MHz MOBILE ..... £229.99  
 100 memories, 5 search bands, including **FREE** mains adapter worth £4.95
- JUPITER MVT 5000 Hand-held ..... only £249.00  
 25 to 550MHz and 800 to 1300MHz, 100 Memories
- NEW JUPITER MVT 6000 mobile ..... SPECIAL OFFER £319.00**  
 25 to 550 MHz and 800 to 1300MHz, 100 Memories

MANY OTHER TYPES & MODELS STOCKED - SAE FOR DETAILS & USED LIST

## HP100E/AR1000

### FAIRMATE HP100E

Since its launch a few months ago, this has become the UK's most popular scanning receiver. The HP100E covers 25 to 550MHz and 830 to 1300MHz with selectable channel steps of 5, 10, 12½ or 25kHz. You can also program channel steps in any multiple of 5 or 12½kHz up to 100kHz. With 1000 memory channels arranged in 10 banks of 100 the scanning functions are really versatile.

Three modes are available - AM, WFM and NFM. This means that you can also listen to your local FM radio station as well as Heathrow approach or your local VHF repeater.

If that's not enough, **Raycom** have an exclusive British made shortwave converter. The converter and a small mod are all that's needed to add 200kHz to 30MHz coverage to your HP100E (or your AR1000!)

- HP100E/AR1000 ..... £249.00
- SW Converter ..... £59.00
- Modifications ..... £15.00
- Total regular price ..... £323.00**

**SAVE MONEY - SAVE £24!!**  
**RAYCOM PACKAGE DEAL £299.00**

## AOR AR-3000



There are many scanning receivers to choose from today but several features make the AR3000 stand out from the others. Frequency coverage is from

100kHz to 2036MHz—**NO GAPS!** It is truly multi-mode, covering WFM, NFM, AM, USB, LSB and CW. Frequency steps are programmable in 50Hz steps from 50Hz to 100kHz (so you do get 9kHz steps on MW). It has 400 memory channels in four banks of 100 so can store all your favourite frequencies and can search through these at 20 channels per second. It can also perform a limited scan in each of the four banks and an accessory socket can control a tape recorder remotely, and a built in clock/timer helps. For computer buffs, full control over all functions is available via a built in RS232C interface. Details of operating protocols are in the manual and best of all, **it's in stock now!!!**  
**AOR AR3000 ..... £740.00**

## CHARGE IT!

Why not take advantage of the **RAYCOM Credit Card** and spread the payment for that scanner you've always wanted. Example: Yaesu FRG9600 MKV package £70 deposit and £28 per month (APR 36%). Call for a quote and written details! Licensed credit broker.

## YAESU FRG9600



- 9600 standard 60-905MHz ..... £469.00
  - 9600 MkII 60-950MHz ..... £499.00
  - 9600 MkII pack 60-950MHz .. £545.00
  - 9600 MkV 0.2-950MHz ..... £625.00
  - 9600 MkV pack 0.2-950MHz .. £699.00
  - Standard to MkII upgrade ..... £ 40.00
  - Standard to MkV upgrade ..... £149.00
  - MkII to MkV upgrade ..... £129.00
- All packs include PSU and ROYAL 1300 discnet!

RAYCOM COMMUNICATIONS SYSTEMS LIMITED, INTERNATIONAL HOUSE, 963 WOLVERHAMPTON RD, OLDBURY, WEST MIDLANDS B69 4RJ. TEL 021-544-6767, Fax 021-544-7124, Telex 336483 IDENTIG.

**RAYCOM**  
 COMMUNICATIONS SYSTEMS LIMITED

Telephone 021-544-6767

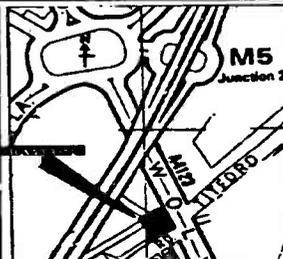

**RAYCOM gives you more BUYING POWER**  
 ALL MAJOR CREDIT CARDS ACCEPTED. BC, ACCESS, DINERS. INSTANT CREDIT UP TO £1000 (SUBJECT TO STATUS) WITH RAYCOM CREDIT CARD (APR 36%). INTEREST FREE CREDIT ON CERTAIN ITEMS AT MRP. CALL FOR MORE DETAILS.

#### ORDERING INFORMATION

WE STOCK ICOM, YAESU, BEARCAT, MFJ, BUTTERNUT, CUSHCRAFT, AEA, NAVICO, STANDARD, TEN-TEC AND WELZ AMONG MANY OTHERS. SEND SAE FOR FULL LIST.

TEL: 021-552-0073

PHONE BEFORE 4PM FOR NEXT DAY DELIVERY BY COURIER (£15.00) - OR 2PM FOR DELIVERY BY POST (£10.00). PLEASE ALLOW TIME FOR CHEQUES TO CLEAR. MANY OTHER ITEMS IN STOCK. PLEASE CALL FOR MORE INFO AND FOR EXTRA SPECIAL DEALS!

INFOLINE 0836-771500 5-9pm (week days)

OPENING HOURS 9-5.30 MON TO SAT,  
 73 DE RAY GAKZH, TOM G6PZZ,  
 COLIN and JOHN on the hotline.

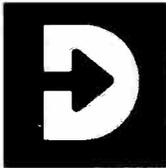

**D A T A L O G**  
E L E C T R O N I C S L I M I T E D

Clayton Wood Close  
West Park  
Leeds LS16 6QE  
Tel: 0532 744822  
Fax: 0532 742872

## For products you can rely upon to give amazing results

For information on **Active Antennas, RF Amplifiers, Converters, Audio Filters, the Morse Tutor and Speech Processors** send or telephone for a free catalogue and selective data sheets as required.

All our products are designed and made in Britain.

Orders can be despatched within 48 hours subject to availability.



— VISA AND ACCESS WELCOME —

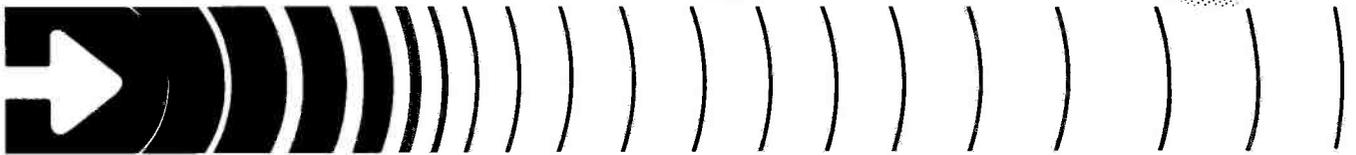

# TURBO-CHARGE YOUR SCANNER !!

Do you own an **R7000, FRG9600** or **AR2002?**

Why not upgrade your Scanner into a professional monitoring station with the **SCANMASTER** remote control unit from E.M.P. Ltd

**SCANMASTER** plugs into the 'Remote' socket on your scanner and takes over its operation and hence greatly expands the facilities and functions available.

**SCANMASTER** is like a T.N.C. in that you supply it with 12 volts D.C. and talk to it with a terminal via its RS232 interface.

**SCANMASTER** can be left stand-alone for un-attended monitoring.

**SCANMASTER** is in constant use by many 'official' organisations.

**SCANMASTER** has many powerful and easy to use features such as:

- \* Over 700 memories available.
- \* Remarks can be assigned to memories.
- \* Parallel Printer Interface for hard copy output.
- \* Real Time Clock for time/day logging.
- \* Frequency offset button for split channels.
- \* Signal strength logging via A/D.
- \* Squelch relay output for switching tape-recorder On/Off.
- \* Versatile search facility.
- \* Extensive User Manual.
- \* And many more features.

**Special Price (UK) .....£149.99 including Postage & Packing.**

28 day money back guarantee if not entirely satisfied. When ordering, please state which scanner you have.

**E.M.P. Limited . 51 High Street . Portland . Dorset . DT5 1JQ . Tel (0305) 826900.**



Despatched by return of post (subject to availability).  
Main Dealer: Garex Electronics. Tel: (0364) 72770 Fax: (0364) 72007.  
Dealer Enquiries Invited



# AIRBAND

## Godfrey Manning G4GLM

This year's biggest disappointment for your intrepid Airband team was braving one of the public days at the Farnborough show. The two-vehicle entry lanes couldn't cope with the expected 70 000 visitors. The crowd was led into crushingly dense, blind alleys in the static park and ambulances had to dodge their way through the spectators.

On the other hand, all four exhibition halls were almost empty of visitors. No wonder many exhibitors gave up early. A little more support from the visiting enthusiasts would have made the exhibitors' efforts worthwhile but at least yours truly didn't have to fight through a crowd! I still don't know why the Antonov 225 didn't display on the Sunday but, well, these things happen. All in all, an event I'd rather miss. I personally would prefer to support my local air show where I'll get better value for money.

I hope **Dave Lawrence G6HXR** (Snodland, Kent) enjoyed the Warbirds display at West Malling. Apparently, despite rumours to the contrary, there may be another one (most likely August Bank Holiday 1991). Dave also visited Biggin Hill and recommends the shop there. He reminds us that *High in the Sky* is due to emerge in its next edition and is a valuable Selcal/registration tie-up source. The Heathrow a.t.i.s. is now relayed on the Biggin v.o.r. (BIG: 115.1MHz).

## Hardware

Perhaps I'm the only one to be confused by the Skyscan DX antenna from our regular advertiser SRP Trading, but I think a note about the technicalities of this device would help. Each antenna covers all of the frequencies mentioned in the advert, not just one sub-band. Inside the tubular, plastics sleeve is a nest of elements which combine together to give the required bandwidth. This would be a cheaper and more compact substitute for a discone. Termination is an SO-239; pity it's not a lower-loss BNC or N. If installing outdoors, don't forget to waterproof the connection with self-amalgamating tape. An easy source of this is the leak repair tape sold for do-it-yourself plumbing. Remember to peel the plastic backing off the tape and to stretch well when applying. Finish with a layer of ordinary pvc insulating tape.

## Question Time

Like me, **Dave Seton** (Heald Green, Cheshire) has been interested in aircraft from a very early age, and the novelty endures - in his case after 27 years! Dave sometimes has the chance to watch aircraft as part of his job on BBC Outside Broadcasts. He asks how the Spitfire, Hurricane and Lancaster of the Battle of

The display season - now just a memory - is recalled in this month's column.

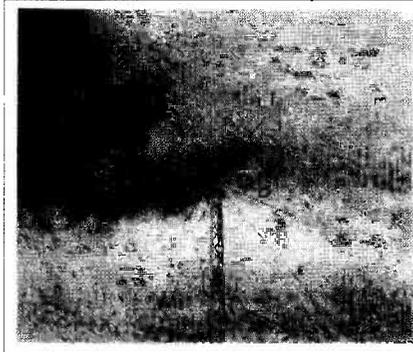

The Radnor n.d.b. (RNR, 404.5kHz).



Britain Memorial Flight communicate while displaying. Most usually they simply talk on the v.h.f. frequency on which the display is being controlled. Throat microphones are in use due to the high cockpit ambient noise, so the voices sound as if strangled. That's because they are! If you don't believe me, come and try the throat mic in my Museum (Tel: 081 - 958 5113); it feels uncomfortable and sounds strange. Think what it's like on a long flight.

Some questions from **P.J. Salisse** (Highgate, London). I don't know the answers so over to you: where's reporting point KRAUT and what is the callsign ROOK? One I can help with is the Novair h.f. operations control. This is (was?) based in a hangar at Gatwick Airport. Novair itself has now ceased trading - a sad story of an airline being bought as peripheral business by a larger organisation which then decided the returns weren't high enough.

Who can quote the locations of the following reporting points (given with their associated bases)? SHACK

(Alconbury), EAST FIX (Upper Heyford), KAREN, DALE, MARY (Bentwaters, Woodbridge) GATE ALPHA (Wash Range). **Jon Harrowing** (South Humberside) is asking.

**Simon Lucas** (24km from Leeds/Bradford Airport) questions position reporting. Over the North Atlantic, aircraft report on reaching pre-determined positions as listed in their flight plan clearances. This means a typical reporting interval of around 20 minutes. Military traffic might have other procedures requiring, perhaps, more frequent reports. Unfortunately it is hard to comment in this column since there is not much publicly available information on the less consistent military procedures.

## Follow-Ups

Now for a musical interlude. In the September issue **Dick Casey** (Bansha, Co. Tipperary) reminisced about the broadcast version of Airmet. **Geoff Halligey** (Bridgend, Mid-Glamorgan), one-time aircraft radio operator, remembers this 290kHz a.m. service from about 1945 to the mid-50s. An RAF bandsman played the interval signal on a trumpet. The notes are GCAGEAGCDEG and take on the time values necessary to send 'AIRMET' in Morse (di-dah, di-dit, di-dah-dit, dah-dah, dit, dah). All the notes are in the octave based on middle C apart from C which is one octave higher. This is rather hard to imagine so why not ring our RADIOLINE on 0898 654676 where, soon after this issue is published, you'll be able to hear a rendition of this long-lost tune - played by guess who.

In September **Terry Ford** (Sheffield) queried two frequencies. Research by **Thomas Goode** (Chesham, Buckinghamshire) reveals 122.75MHz to be the Danger Area Activity Information Service for D306 Cowden Range and D307 Donna Nook. 135.0MHz remains a mystery.

Some readers have asked to see the appearance of an n.d.b. **Alan Jarvis** (Cardiff) took the photos which show the Radnor n.d.b. with the top of the mast which is, presumably, some sort of 'capacity hat' loading arrangement. Thanks for donating the slides to my Museum, Alan.

## Frequency & Operational News

First, the *General Aviation Safety Information Leaflet 8/90* from the Civil Aviation Authority. The only frequency change since last time is that the Sumburgh v.o.r. moves up from 117.30 to 117.35MHz. Then there's *Aeronautical Information Circular (AIC) 66/1990* from the same source which announces the

# AIRBAND

closure of runway 15/33 at Southend. Lastly *AIC 65/1990* introduces the Shannon Oceanic Transition Area (SOTA) which will be controlled from Shannon, not Prestwick.

Bounded by N5100 W01500 - N5100 W00800 - N4830 W00800 - N4900 W01500 this block is immediately south of that tongue of Shannon flight information region sticking out to the west of Ireland. Controlling frequencies are yet to be promulgated.

Thanks **Tim Christian** (North Walsham, Norfolk) who adds 6.628MHz to those frequencies previously mentioned as newly acquired by New York and Santa Maria. In the Mediterranean 5.661MHz is operated from Malta.

Local information from **Dave Seton** is that Manchester Ground is now on 121.8 with the old frequency, 121.7MHz, becoming Manchester Delivery. The full title is clearance delivery. Prior to engine start, aircraft call to confirm slot times and the airways clearances to be followed after take-off. If the slot time is delayed there might be no point in starting the engines too early.

The delivery controller typically has landline communication with departure

Abbreviations			
AIC	Aeronautical Information Circular	MHz	megahertz
a.m.	amplitude modulation	mic	microphone
ATCC	Air Traffic Control Centre	Mil	Military
a.t.s.	automatic terminal information service	mins	minutes
DAAIS	Danger Area Activity Information Service	n.d.b.	non-directional beacon
h.f.	high frequency	pvc	polyvinylchloride
kHz	kilohertz	SOTA	Shannon Oceanic Transition Area
		v.h.f.	very high frequency
		v.o.r.	v.h.f. omnidirectional radio range

flow management regulation, that necessary evil of our congested airspace, and this is how slot times are issued. It remains the responsibility of ground movements control to ensure that aircraft don't come into conflict whilst taxiing.

**Alan Jarvis** found out why Filton Approach moved from 130.85 to 122.72MHz. The frequency was shared with Belfast Harbour (now called Belfast City) who would sometimes try to answer when flights called Filton.

**Colin Frowen** (15 Poveys Close, Burgess Hill, West Sussex, RH15 9TA) offers readers copies of his latest Europe & Mediterranean ATCC frequency list providing a stamped addressed envelope is supplied. Highlights are new frequencies of 132.025 at Brest and 135.15MHz at Paris upper airways. Colin

also mentions new North Atlantic NAT-A frequency 8906kHz.

**Ron King** (Lewes, East Sussex) would like me to bring to your attention some frequencies that are listed in the official publications. London Mil North is on 262.8 and South 250.6MHz. The new Eastern Radar primary contact frequency is 268.2MHz. The London Joint Area Organisation has new frequencies for each of its five sectors: Pole Hill/Irish Sea 285.9; Daventry 289.6; Clacton 232.5; Dover/Lydd 290.15; Seaford/Hurn 293.65MHz.

I've enjoyed your letters as ever this month; back with you again next time.

The next three deadlines (for topical information) are November 2, November 23 and December 7. All letters to the *SWM* offices please. □

## SERVICES

### Subscriptions

Subscriptions are available at £19 per annum to UK addresses £21 in Europe and £22 overseas. Subscription copies are despatched by Accelerated Surface Post outside Europe. For further details see the announcement elsewhere in this issue.

Airmail rates for overseas subscriptions can be quoted on request. Joint subscriptions to both *Short Wave Magazine* and *Practical Wireless* are available at £32 (UK) and £37 (overseas).

### Components for SWM Projects

In general all components used in constructing *SWM* projects are available from a variety of component suppliers. Where special, or difficult to obtain, components are specified, a supplier will be quoted in the article.

The printed circuit boards for *SWM* projects are available from the *SWM* PCB Service. See page 11 for full details.

### Back Numbers and Binders

Limited stocks of most issues of *SWM* for the past ten years are available at £1.65 each including P&P to addresses at home and overseas (by surface mail).

Binders, each taking one volume of the new style *SWM*, are available price £4.50 plus £1 P&P for one binder, £2 P&P for two or more, UK or overseas. Please state the year and volume number for which the binder is required. Prices include VAT where appropriate.

Orders for p.c.b.s, back numbers, binders and items from our Book service should be sent to **PW Publishing Ltd., FREEPOST, Post Sales Department, Enefco House, The Quay, Poole, Dorset BH15 1PP**, with details of your credit card or a cheque or postal order payable to PW Publishing Ltd. Cheques with overseas orders must be drawn on a London Clearing Bank and in sterling.

Credit card orders (Access, Mastercard, Eurocard or Visa) are also welcome by telephone to Poole (0202) 665524. An answering machine will accept your order out of office hours.



# CODE 3 DATA DECODING SOFTWARE

Mike Richards G4WNC

The IBM PC and its clones are becoming increasingly popular among amateurs and short wave listeners. However, there has been very little in the way of multi-mode decoding software designed primarily for the listener. That has now changed with the introduction of the Code 3 decoding package from Hoka Electronic in the Netherlands.

In its basic form it covers an incredible 24 data modes from Morse code right through to 4-channel t.d.m. As you can imagine it is not possible for me to give detailed coverage of each of these modes here. Instead I will give a general overview with a detailed look at some of the more interesting features.

## Starting Up

The package was supplied as software on a 3.5in disk and a separate f.s.k. converter. The first thing to establish was the system requirements, which fortunately were quite basic. Code 3 required an IBM compatible computer running with DOS 2.0 or higher and at

**With the rapidly growing interest in utility stations, any new decoding package inevitably attracts much attention. This new system from Hoka represents something of a breakthrough in true multi-mode decoding.**

least 640K RAM. The graphics display can be either CGA, EGA, VGA or Hercules, which covers all the common types. The only other essential is a standard serial port that is used to handle the output from the f.s.k. converter.

around a summary of the key functions for each available mode. Whilst this was useful there was none of the essential background information necessary to get the best out of the program. An example of this was the internal buffer options that are in fact a very powerful and unique feature. There was no description of how these operated and how useful they could be for identifying unusual modes. The only areas where there was some background was the analysis modes, but I felt even this was inadequate. I suspect these inadequacies

special program missing, I could only operate from the floppy. The disadvantage of this being rather slow disk access times.

One important area that was not mentioned anywhere, was calibration of the interrupt frequency. This is important as it effects the timing of the whole program and the accuracy of the baud rate measurement. I was fortunate in that the default settings matched my Amstrad PC-2086 computer so no adjustment was necessary. For anyone who is not so lucky, it was a case of trial and error. The interrupt frequency had to be adjusted until correct baud rate indications were given for a station of known speed.

## Hardware

The hardware side of the installation was very straightforward. The f.s.k. decoder supplied for the review was the top of the range LF3. This was housed in a plastics case measuring 190 x 110 x 70mm. The decoder was mains powered via its own internal power unit, the power being supplied by a standard two-pin continental plug. The connection between the computer and the decoder comprised a 500mm flying lead that was terminated with a 9-way D connector. This lead was simply connected to the serial port on the computer. In my case I had to change the plug as the Amstrad has a 25-way serial port.

The only other connection required was the audio output from the receiver to the decoder. This again was very simple, as a standard phono socket was provided on the front of the LF3 decoder. There were no details of the audio level requirements in the manual, but the review decoder worked perfectly with input levels between about 10mV r.m.s. and 2.0V r.m.s. This wide range meant that it should work comfortably with most common receivers.

## Facilities

Once the program has started you are presented with a multi-screen menu that listed all the decoding modules and facilities. The selection of the required module being simply a case of moving the highlight with the cursor keys until it is over the desired module. This was a standard arrangement that was quick and easy to use.

Probably one of the basic requirements of a utility decoding system is a good tuning indicator. The Code 3 handles this area extremely well. The most useful when first tuning in to a station is the SHIFT SPEED MEASUREMENT. This gives a l.f. spectrum analyser display on the screen with a calibrated X axis. Calling this feature



With a complex package such as this, a manual is essential. The Code 3 was supplied with a twenty-page, A4 size, manual, that was bound in a simple plastics cover. This system had the advantage that updates or user information could easily be added to the manual. Sadly the manual content was rather limited and left many areas with no coverage at all.

The main core of the manual centred

stem from the need to translate the original, but it seems a shame to spoil such a good package with a poor manual.

There was one redeeming feature and that was the on-line help screens. These were available for most of the decoding modules. These were accessed by pressing ? with the appropriate mode selected.

Moving on to the installation, the Code 3 was supplied on a floppy disk but the manual contained details of how to install on a hard disk. Copy protection was very effective being based around a security file. This file had to be transferred to your working disk using a special program. As the review copy was supplied with this

# CODE 3 DATA DECODING SOFTWARE

a tuning indicator was something of an understatement as it was really a comprehensive analysis mode. Tuning information was given as a spectrum analyser display and also as the off-set in Hz from the centre frequency.

As if this wasn't enough the measured shift was displayed and baud rates for asynchronous and synchronous signals. If you needed more detail on the baud rate a precision measurement could be taken that had a resolution of 0.0001 baud! There was also an option to use the spectrum analyser in averaging mode where subsequent scans were averaged together. So you can see that this was an extremely useful feature and one of the best I have encountered.

Once a station and mode had been selected there was another more conventional tuning indicator provided with all the text modes. This comprised a simple bar display at the top of the screen with two square blocks, one for mark and the other for space. The correct tuning point was when these blocks straddled the centre point of the display. Before we leave the tuning aspects I ought to mention the automatic threshold. This was available from most modes and provided automatic correction of receiver drift for up to 30% of the selected shift. This was very useful when monitoring stations for long periods, as it minimised the need to compensate manually for receiver drift.

Once the receive module had been selected, you were presented with a status panel at the top of the screen that showed the selected mode and the current setting of the various parameters. Changing parameters was achieved with single key presses e.g. - or + to raise or lower the baud rate. With so many modes included it was clearly not possible to have one set of key definitions. The

result being that these varied from one mode to the next. However, where possible, common keys were used. Details of the key functions for the current mode could be obtained either from the manual or by typing '?', which was handy. The only snag with this system was that when you returned to the decoding module the parameters were changed to the default values.

With so many modes included in the Code 3 it is not possible to give a complete description of all the facilities in each mode. What I will attempt to do is to cover the most significant of these facilities.

## Inverted Signals

One of the basic necessities of this type of program is to be able to cope with inverted signals where the mark and space frequencies are reversed. The Code 3 handles this with the 'M' key. This acts as a toggle, providing a mark to space reversal when the key is pressed. Another troublesome area with some modes is multiple carriage returns where lines of text are printed double spaced. By pressing 'R' the program automatically inhibits the printing of multiple carriage returns.

The Code 3 could be set to work to any one of ten separate shifts ranging from 85Hz through to 1000Hz. The selection technique was quite novel but effective. First the S key is pressed followed by a number between 1 and 0 according to the required shift. An interesting point to note here is that this wide range of shifts was rarely needed. This was because of the way the advanced decoding logic handled the signal. In most cases the shift could be left at the default 1000Hz.

When receiving codes that employ a

shift character, it's useful to have an un-shift on space feature to provide rapid correction of missed shift characters. This facility was included in the Code 3.

Another area that can be frustrating, is the screens full of rubbish that you tend to get when tuning around the bands. This is not a problem with the Code 3 as you have the option to inhibit the screen output whenever you like. Related to this was the ability to take a hard copy or print-out of the receive text.

This leads on nicely to the internal buffer and disk capture features of the Code 3. This is an area where the Code 3 performs very well. With many systems the internal buffer simply stores the decoded text for later retrieval. The Code 3 differs in that it actually stores the raw data. This system comes into its own when analysing and decoding new signals as you only need to grab a sample of the signal. You can then sort out the correct decoding mode at your convenience! The basic disk storage facility saves the raw data buffer to a file of your choice. The only disadvantage with this system is that the data takes a lot of disk space, as a full buffer is approximately 260K.

If the ASCII storage option is fitted you can store decoded text to disk in much the same way as some more conventional decoders.

## Operating Modes

As I mentioned earlier, in its basic form the Code 3 can handle some 24 modes and this can be increased further if required. I have shown the basic specification of these modes in a separate table for clarity. Let's have a closer look at some of the modes.

The implementation of AX-25 amateur packet was very good and could handle

```
|| c[R]i           [M]arklevel = 0           BUFF [T] [O]D [Y]P ||
|| [U]os          [S] 300 [B]aud 50.00      Read      1150 ||
||                ITA-2          mask 0 >< B Y [A]tc  Write  1181 ||
```

zczcaa

092421 - vietnamese government delegation here.

pyongyang september 24 (kcn) -- a vietnamese government delegation headed by tran luo, minister of heavy industry, arrived here today to attend the second meeting of the inter-governmental committee of economic and scientific-technological cooperation between the dprk and viet nam.

it was met at the airport by kye hyong sun, minister of machine industry, and nguyen van trong, vietnamese ambassador to korea.

the administration council gave a banquet for the delegation in the evening. -0-

nnnn

Hoka Code 3 RTTY screen dump.

# WHAT SCANNER

AUTUMN 1990  
£1

**WHAT SCANNER**  
*Comprehensive details  
of available makes*

**NEWSCAN**

**WHAT IT ALL MEANS**  
*Terminology Explained*

*Reviews*

**BLACK JAGUAR**

**HOWES AA2 ACTIVE  
ANTENNA**

*Plus*

**SCAN THESE!**  
*Handy Book Reviews*

**SCANNING THE MARINE  
BANDS**



# INTRO

Scanning is becoming an evermore popular part of the radio hobby. Many scanner users don't consider themselves radio hobbyists, so 'normal' is this past-time!

It can be a very interesting hobby whether you have a specific interest in one section of the spectrum, like airband, or whether you enjoy listening to many different types of signals. We've not attempted to address the 'legality' argument. Instead we would draw readers attention to the comment made by Peter Rouse in 'Marine Bands'.

Buying your first scanner can be just as much of a headache as trying to change to a better model. This is where our comparative guide comes into its own. All the information has been obtained from either the manufacturers, or our own review tests.

Many newcomers stumble over the jargon involved - we've tried to explain the most common terms.

We can't hope to be 'all things to all scanner users', but let's hope you all enjoy reading this edition of *What Scanner*. Don't forget there is a regular scanning column in *Short Wave Magazine* every month and many new scanners on the market are reviewed all year long.

Finally, thanks to Nevada for the loan of the scanners on the front cover.

EKR

# NEWSCAN

## Tandy Modifications

Owners of the Tandy PRO2005 and PRO2005 scanners may be interested to know of a modification that adds a search and remember facility. There are two modification modules available.

The PS-90 has two modes of operation. A simple mode where frequencies found during a search are stored in the ten monitor memories and a complex mode where the frequencies are stored directly in the scanner's main memory.

The SS-45 module has only one mode of operation and this stores the frequencies found in a search in the monitor memories.

For full details on these modules and information on fitting them, contact:

**B.S. Sutherland, 336  
Charlton Road, Bristol BS10  
6JZ. Tel: (0272) 500742.**

## The Comet Range

Arrow Radio are importers of the Comet range of antennas and recently the range has been expanded to cover the scanner market.

The CRZ12DB is an active antenna for base station use. Powered from mains via a small power unit, the antenna consists of a multiple stripline printed circuit antenna within a robust glass-fibre mast assembly only 1.24 metres long. The antenna offers wide-band reception between 500kHz and 1.5GHz, with an antenna gain of 9dBi. A further gain is provided by the controller (up to 16dBi), which is installed near to the receiver in use.

The CRZ12DB, as supplied, includes the antenna, mast support, clamps and controller, together with a metric PL259 plug for RG58 cable and a d.c. coaxial plug for providing 12V d.c. to the controller from any suitable source.

Please note, the antenna

must not be used for transmitting.

The CRZ-07 is an active antenna, designed for mobile use. It consists of a stainless steel whip, 1.02m long with base loading that fits a standard SO239 socket that can be gutter, hatch-back or single hole mounted using Comet standard fittings.

A controller, with a curly cord and cigar lighter plug, is provided. The antenna affords coverage of 500kHz to 1.5GHz with 9dBi gain and up to 16dBi gain from the controller. Again, this antenna is not suitable for transmitting.

The CRZ12DB is available for £96.30 plus 3.00 post and packing. The CRZ-07 costs £66.50. Both are available from **Arrow Radio** outlets in Chelmsford, Glasgow and Wigan. Otherwise the Comet range of antennas are available from Sandpiper, Dee-Comm, Long Electronics (Eire), KW Electronics, Raycom Communications and others.

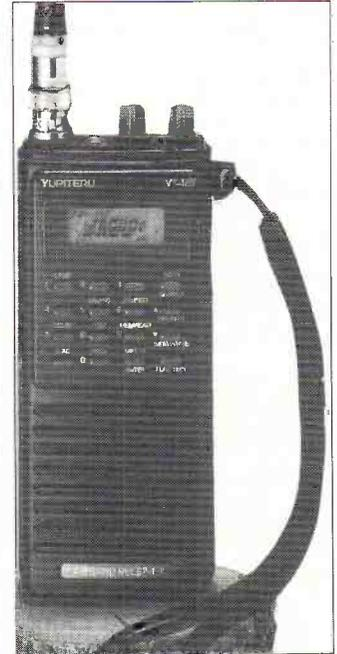

## Yupiteru in the UK

Nevada Communications has just been appointed the UK distributor for the Yupiteru range of scanning receivers. Although some of their radios were imported last year, they were sold in the UK under the Jupiter label. This will be the first time they have done direct business under their brand name in the UK.

Nevada have just released the first of a programme of new models - the VT-125. This hand-held covers 180-142MHz and has been designed to give maximum performance in the airband range. It has many features including 30 memory channels, 50/100kHz steps, priority, delay, etc., and is expected to retail at £169.00.

Keep your eyes open as **SWM** hopes to have one of these new sets for review very soon.

**Nevada Communications,  
198 London Road, North End,  
Portsmouth PO2 9AE. Tel:  
(0705) 698113.**

## The Gulf Situation

In the early hours of 2 August 1990, Iraqi armoured divisions, backed-up by over 100 000 troops entered the small Gulf state of Kuwait. So, what's really happening out there? Is it only the radio and TV stations that can find out?

The new book *Monitoring the Iraq/Kuwait Conflict* answers both those questions. It shows the reader how to listen into the in-flight conversations between the fighters in the Gulf, ship-to-shore calls, the US Navy and broadcast stations. It explains where to find the action, saving hours of scanning the bands, and clearly details what will be heard and the background. Not only are there many frequencies that have been monitored by the author, but also sections on the joint US and Gulf Air Force, VIP and presidential flights, commercial aviation and Gulf shipping.

The 24-page, A5 book is available from the publishers at £3.95 plus 50p postage in the UK, overseas postage is 75p for the EEC and sea mail or £1 for airmail.

**Interbooks, 8 Abbot Street, Perth PH2 0EB. Tel: (0738) 30707.**

## MONITORING THE IRAQ/KUWAIT CONFLICT by Langley Pierce



A guide to monitoring the radio transmissions of Aircraft, Ships and Military in the Gulf.  
- Lists the latest frequencies in use. -

# WHAT IT ALL MEANS

**Scan:** The term used to describe the type of operation where the receiver runs through frequencies which have been pre-programmed into the equipment memory channels by the user. For example, local airport frequencies or amateur repeater channels. The receiver scans through these memory channels and stops when a signal is detected. The number of memories that can be scanned depends on the make of the receiver, but most offer a minimum of 20, with the facility to 'lockout', or temporarily remove, from the scan, those memories which are not of interest at the moment.

**Search:** Often confused with Scan, this is the other main feature on most receivers or scanners. If you don't know the exact frequency that a particular service operates upon but you have a rough idea, or perhaps you want to monitor activity on one of the amateur bands, then use can be made of the search facility. The user programmes into the receiver the upper and lower frequency limits of the band to be searched, and also the frequency step size that the receiver is to search with. The receiver then automatically searches over the set range and stops when a signal is detected.

**Signal Strength Meter:** This is useful in determining how close a received station is, or how good a particular antenna is.

**Tuning Knob:** Most receivers only have UP and DOWN buttons to permit manual tuning of the receiver (other than by direct keyboard entry). This can be very frustrating if you wish to quickly change from one frequency to another, or want to manually search for new active frequencies. If you think that you may wish to do this, then consider the provision of a tuning knob very seriously.

**Squelch Relay Output:** Useful if you want to monitor frequencies over a long period of time by connecting a tape recorder to the receiver. Doing

this permits you to compress several days of activity into just a few hours.

**Computer Interface:** If you are interested in finding new frequencies or logging channel usage then this is the option to look for. Many receivers now boast of computer ports and an increasing amount of software is becoming available, making it very easy to get sophisticated systems running.

**Sensitivity:** This is the ability to hear signals and should be lower than  $1\mu\text{V}$  for 12dB S/N on a.m. and  $0.5\mu\text{V}$  for 12dB S/N on n.b.f.m.

**Selectivity:** This is the ability to reject unwanted signals on adjacent frequencies. The best choice seems to be around  $\pm 7.5\text{kHz}$  at -6dB for most services in Britain, but up to  $\pm 12\text{kHz}$  at -6dB is usable.

**Spurious response/image rejection:** This is the ability to reject unwanted signals. The image rejection is usually a problem with older designs of receiver and can result in the other transmissions interfering with the wanted signal. It is generally worse on the u.h.f. ranges of receivers where the wider bandwidth circuits cannot provide such a high degree of selection of the wanted signal as is possible on the lower frequency ranges. One common manifestation of this problem is that of local police transmissions appearing in the 430MHz amateur band, usually making reception of weaker signals impossible. A minimum of 50dB rejection should be expected for both image and other spurious responses, however a lower figure is to be expected on hand-held models as a result of design economics in order to get the circuitry to fit inside the case.

**Frequency:** This is the actual spot in the radio spectrum that a signal can be found. Frequency used to be expressed in terms of wavelengths, however as radio developed over the years it became more common to define it as the number of variations or

cycles the electromagnetic wave that forms the radio signal alternates through a second. In modern times, the unit was renamed hertz after one of the pioneers of radio communication. Unfortunately, this can lead to confusion as the term is rather less descriptive than its predecessor. The relationship between wavelength and frequency is fixed by the rate at which radio waves travel through the air. This is 300 million metres per second - which happens to be the same as the speed of light, another form of electromagnetic radiation. Wavelength is obtained by dividing 300 by the frequency in MHz.

**Band:** Is generally used to refer to a group of consecutive frequencies used for a similar purpose. For example the '2m amateur band' extends from 144 to 146MHz and is so-called because the frequency expressed in terms of wavelength approximately to - you guessed it - 2 metres. Actually it's nearer to 2.0689655 metres but what are a few decimal places between friends?

**Channels:** If we now subdivide the band into regularly spaced frequency slots we obtain channels. This makes it simpler for users of a particular band to change operating frequencies. Instead of saying 'change to frequency of one hundred and forty five point five two five megahertz' they can now say 'go to channel S22' which is much easier to remember, providing all the users agree on the same channel numbering system. This also makes life a lot easier for non-technical users of communications equipment for example v.h.f. marine radios, where an operator can simply turn a switch on the equipment to a pre-set channel without having to know the exact operating frequency.

**Hand-held:** A hand-held scanner is primarily designed just for that purpose. It has to be physically small, light-weight and be capable of operating for several hours from an internal battery pack. In order to achieve this, the designer initially has to determine what level of

performance is acceptable.

With a hand-held scanner it is assumed that most of the time operation will only be with a small antenna attached to the receiver. Because of this, the level of signals present at the antenna socket is likely to be very much lower than that which would be expected from an external base station antenna. In order to maximise performance many hand-held scanners have a large amount of r.f. gain, limited r.f. stage filtering and low level of local oscillator injection.

Whilst this is acceptable for hand-held use problems can arise when a larger antenna is connected. If a number of strong signals are present they can overload the r.f. stages of the scanner. Although no physical damage will result it is unlikely that you will be able to hear any wanted signals amongst all the noise and hash produced as a result of strong signals mixing in the r.f. stages.

**Mobile:** Mobile scanners are also designed for use with relatively small antennas but because they can be physically larger than a hand-held and can have a plentiful supply of power from the car battery they can often equal the performance of a dedicated base station scanner. They still have rather high levels of r.f. gain in order to compensate for small antennas and do not have quite as many facilities as you would expect from a base station but they can be used either in or out of the car - providing you have a 12V power supply available.

**Base station:** Base station scanning receivers are often much more bulky than their mobile equivalents. This is usually because of the need to provide an internal mains power supply, but it also has the advantage of spacing out the front panel controls, making operation much more convenient. The r.f. stages are likely to be designed to cope with much stronger signals than their mobile equivalent and many models have additional features such as computer control ports, tape recorder sockets and, in one or two cases, a large tuning knob!

## BLACK JAGUAR BJ2000 MI

By Peter Rouse GU1DKD

**Although not a new scanner, this one does seem to be very popular and we wondered why.**

Although a large number of hand-held scanners are now available on the UK market, the choice for many users, including myself, becomes limited because the vast majority of these receivers do not allow you to program a.m. mode outside the aircraft band. The Black Jaguar falls within the very small group of portables that do allow mode to be programmed with frequency on any band and so was viewed with some interest.

The Black Jaguar, in its Mark II version, has been on the UK market for some time together with an identical scanner marketed under the Challenger brand name (frequency coverage appears to be different on some models).

However, the Mark III is fairly new and has an improved receiver. It is being made to specifications laid down by its UK importer, Nevada Communications, who have also brought the price down. I sought out a sample for review for two reasons. First, I kept hearing good reports from users and second I was in the market for a good hand-held unit myself.

### Band Coverage

The quoted coverage is 26-29.995, 60-88, 115-178, 210-260 and 410-520MHz. Naturally users of this receiver should take great care when tuning through one of the u.h.f. bands shown above as they may accidentally stumble across a whole range of military frequencies (in the event of this happening the user should take note of the Wireless Telegraphy Act and not make any recordings or notes of what they hear nor repeat the content of any messages to a third party).

In fact, the scanner tunes a much wider range of frequencies and on the sample I tested the bands covered were 17.35-29.995, 50-99, 105-184.5, 200-317 and 350-574MHz. Obviously sensitivity will fall-off outside the specified ranges but on a couple of random tests, such as tuning-

in the local a.t.i.s. on 109.4MHz, performance was still usable.

There are 16 memory channels available and each is programmed with frequency, mode, delay and lockout and one one may be assigned as priority. The channels are scanned at a rate of 10 per second and searching is possible between any two user defined frequencies.

### The Box & Bits

The scanner is housed in a plastics case which is sturdy and well finished. It's not the smallest or lightest hand-held on the market but does have a good solid feel and although the case is quite large it is relatively slim and fits easily into a jacket pocket. The keys on the front panel are all single function and clearly marked.

On top of the casing are squelch and volume controls, push-on, push-off switches for power and audio tone and sockets for an earpiece and 6V d.c. input. The antenna socket is a TNC type, which seems an odd choice but an adapter for TNC-BNC is supplied. On the side of

the casing is a push switch which lights-up the l.c.d. and a socket for the NiCad charger.

Other accessories that are supplied with the scanner are a helical rubber coated antenna and a soft, carry pouch which has a transparent window through which the front panel buttons can be pressed. The scanner comes with NiCad battery pack (600mA) and plug-in charger although a two-pin to three-pin electric shaver style adaptor is needed to use it.

There are a range of optional extras available from Nevada which include a vehicle mounting bracket, desk stand, special u.h.f. stubby antenna and mag-mount, vehicle antennas and fast chargers.

### Performance

The Black Jaguar was first subjected to the fumble test. This consists of ignoring the handbook and seeing if you can properly programme the unit and use it without help. I am happy to say it passed with flying colours and is more forgiving than most scanners in that it does not matter whether you

program frequency or mode first.

A selection of locally used frequencies were entered and the scanner left running. Two immediate reactions were that sensitivity seemed better than average for a portable and audio quality was very good (to the point where I wondered why the manufacturers had bothered to include the tone switch). I was interested in the antenna supplied with the set as unlike the close wound helicals supplied with most hand-helds, this one was space wound. Indeed, I did a swap and found that, particularly on the lower band, the Black Jaguar's antenna was obviously performing far better.

I am a great believer in subjective tests but, for once, thought I would put a receiver through its paces on a properly calibrated signal generator. The model I used was not able to provide signals for h.f. and so examination was limited to between 80 and 460MHz. Nevada quote sensitivity for f.m. (12dB SINAD) as 0.5µV at v.h.f. and 0.7µV at u.h.f. Strangely, my own findings were that u.h.f. averaged a fraction above 0.5µV whereas v.h.f. varied between 0.25 and 1.0µV. Even so, on the worse case figures the tail-off below 1.0µV was non-linear and very gradual to the point where, even on the lowest setting of the signal generator, the signal was still only slightly noisy. A figure of 1.0µV (10dB SINAD) is quoted for v.h.f. a.m. and apart from a slight dip in sensitivity at around 150MHz, the figure on the test sample averaged marginally better than quoted across the rest of the range.

### Conclusions

The sensitivity is very good for a scanner of this type (and certainly far better than one of its rivals that shall remain nameless). One minor point that may worry some prospective buyers is that the scanner can only be programmed in steps of 5kHz. This means that some channels based on 12.5kHz spacings are slightly offset however, in practice it seems the filters are wide enough to

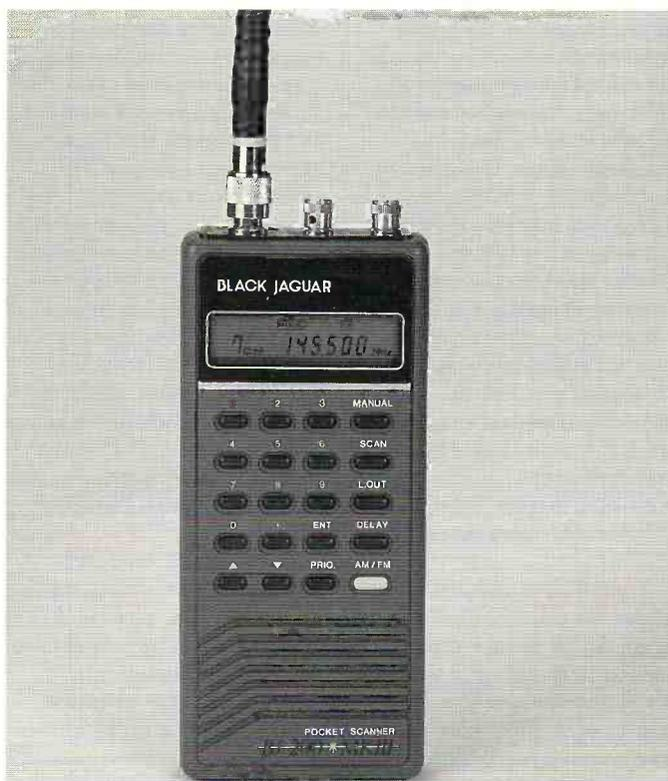

## III HAND-HELD SCANNER

cope and signals can be received with only slight noise. I feel that 16 memories is a bit skimpy compared with most modern scanners where the absolute minimum now seems to be 20.

The set is easy to programme but one criticism concerns the on/off switch which is a push type that requires only a slight pressure. The review sample was borrowed from a friend and during the first fortnight of ownership the button had been accidentally pressed, possibly when put into a briefcase and

the NiCads had discharged and memories were lost.

In the short time I had the set for review, the same thing happened again when the button must have pressed against something. Despite that, I can see why the scanner is so popular and certainly is a very tempting choice at what is a very competitive price.

The Black Jaguar is imported by **Nevada Communications, 189 London Road, North End, Portsmouth. Tel: (0705) 662145** and costs £199.

Abbreviations			
a.m.	amplitude modulation	MHz	megahertz
ATIS	automatic terminal information service	N-type	type of coaxial connector
BNC	type of coaxial connector	s	second
dB	decibel	SINAD	(Signal + Noise + Distortion) to (Noise + Distortion)
d.c.	direct current	TNC	type of coaxial connector
f.m.	frequency modulation	u.h.f.	ultra high frequency
kHz	kilohertz	V	volt
l.c.d.	liquid crystal display	v.h.f.	very high frequency
mA	milliamp	µV	microvolt
MAh	milliampere hour		

### Specification

<b>Coverage:</b>	26-30, 50-88, 115-178, 200-280 & 360-520MHz
<b>Sensitivity:</b>	f.m. 0.5µV for h.f. and v.h.f., 0.7µV for u.h.f. (all 12dB SINAD). a.m. 1.0µV for h.f. and v.h.f., 1.5µV for u.h.f. (all 10dB SINAD)
<b>Selectivity:</b>	60dB ±20kHz
<b>Modes:</b>	a.m./f.m. programmable on any band
<b>Search:</b>	User defined limits
<b>Memory Channels:</b>	16 channels at 10 per second
<b>Programming:</b>	Keypad
<b>Priority:</b>	Yes
<b>Delay:</b>	2s
<b>Lockout:</b>	Yes
<b>Display:</b>	l.c.d.
<b>Power Source:</b>	Internal 600mAh sealed NiCad pack (charger supplied)
<b>External Connections:</b>	Charger, earphone, antenna (N-type)
<b>Additional features:</b>	Supplied NiCads, charger, u.h.f. helical antenna. A u.h.f. vehicle magmount, car mount and desk brackets are available as extras.

Advertisement

# ARE

COMMUNICATIONS  
THE SHOP WITH THE SMILE

**ICOM**  
**IC-R100**

Mobile/UHF-HF Scanner



For the enthusiast who prefers a more permanent installation the IC-R100 is ideal giving full frequency range of 500kHz-1800MHz and AM/FM. FM wide modes of operation. The IC-R100 boasts 100 memory channels to store your favourite stations and has features similar to the little pocket receiver.  
**48 monthly payments of £17.97. a.p.r. 34.4%.**

**CASH PRICE £499**

**WHY SETTLE FOR ANYTHING LESS!**

Only from ARE with SSB facility for USB and LSB at no extra cost.

This is an ARE Modification.



**PHONE 081-997 4476**



Opening Hours Monday-Friday 9.30-5.30  
**NOW OPEN SATURDAY 10.00-5.00pm**

ARE Communications Limited, 6 Royal Parade, Hanger Lane, Ealing, London W5A 1ET. England

Tel: 081-997 4476 Fax: 081-991 2565

By Roger Bunney

Most of the scanner receivers imported into the UK have coverage of the 380-512MHz u.h.f. band. Within this spectrum is a band that carries a vast range of 'local' communications, mainly from hand-held, field units transmitting back to base equipment and mostly operating in simplex mode.

The 440-470MHz is the specific band of interest and, as most scanner users will know, operators within the denoted coverage include factory security, industrial repair teams, marine pilots, local radio outside broadcasts radio links (usually at broadcast quality wideband f.m. although the average scanner, being narrow band f.m., hardly does such broadcast links justice) and radio/TV production talkback, to name but a few. Perhaps of specific interest are the guardians of the law and order, but since you are prohibited from receiving such information you are advised not to listen to such transmissions!

The usual antenna source for a scanner user is the discone, a wide band array largely vertically polarised and omni-directional in response. The author had a specific interest in the 440-470MHz band and lives some miles north of Southampton, screened to the north and west. Since the signals of interest originated to the south, a simple antenna was sought covering 180° with reduced pick-up to the north.

A simple 2-element design was formulated and worked well. It was found that although reception into Southampton some 16km distance was possible - even to hand-held units in the streets back to base - weak reception from Portsmouth

base stations was also possible. Obviously construction of a Yagi would increase signal gain but the loss of the relatively wide beamwidth would be unfortunate. The simplest means to increase antenna output was to 'activate' the dipole and a basic amplifier was eventually constructed in the dipole insulator itself, powered from an indoor p.s.u. similar to domestic u.h.f. TV masthead amplifiers.

The antenna in its 2-element form will give some 3dBd of gain into 75Ω nominal unbalanced. The two prototypes used Band I antenna insulators (large enough to fit a pre-amplifier in easily) with 12.5mm o.d. element rod, thus further enhancing the wide-band performance. The reflector also used Band I type material. Obviously the antenna can be constructed with material to hand - especially if its being fitted inside the roof space - but if external mounting is envisaged then an environmentally protected housing should be used (i.e.

doesn't let the rain in). With the sad demise of 405 line TV, many antenna riggers will be pleased to let you salvage Band I materials from their yard, though a source of ready-made antennas for this coverage is provided later.

Whereas the prototypes were used geographically to one end of a coverage area and limited pick-up could be accepted, there are many locations, such as in the middle of a city, where omni-directional coverage is needed, in such a case the reflector can be omitted. To minimise polar diagram 'holes' caused by the mast, a stand-off of at least 500mm should be considered advisable.

## Construction

Antenna construction is simple, though if the omni-directional coverage is needed and just a single half-wave dipole is fitted, it should be cut longer, say 315mm overall. At least a 460mm stand-off should be sought to optimise the polar diagram. Construction of the amplifier module within the

dipole housing is relatively simple. A piece of **single-sided p.c.b.** material is cut to fit inside the dipole insulator itself, which is normally circular.

The prototypes had two holes drilled to suit the original screw connectors fitted in the housing. One of the screws is soldered into its brass housing (which in turn connects to the antenna element through the body of the insulator itself). The other screw is removed from its brass housing and a 20s.w.g. wire, about 75mm long, is soldered into the brass housing. The brass through-links are best removed from the dipole for this operation.

Once soldering is completed, re-fit the brass fittings. Now fit the circular, single-sided p.c.b., **copper uppermost**, into the dipole insulator with the soldered-in screw protruding through one of the holes drilled earlier in the p.c.b. The 20s.w.g. wire should be passed through the other hole. The protruding part of the soldered-in screw is now soldered to the p.c.b. copper earth plane, thus making one

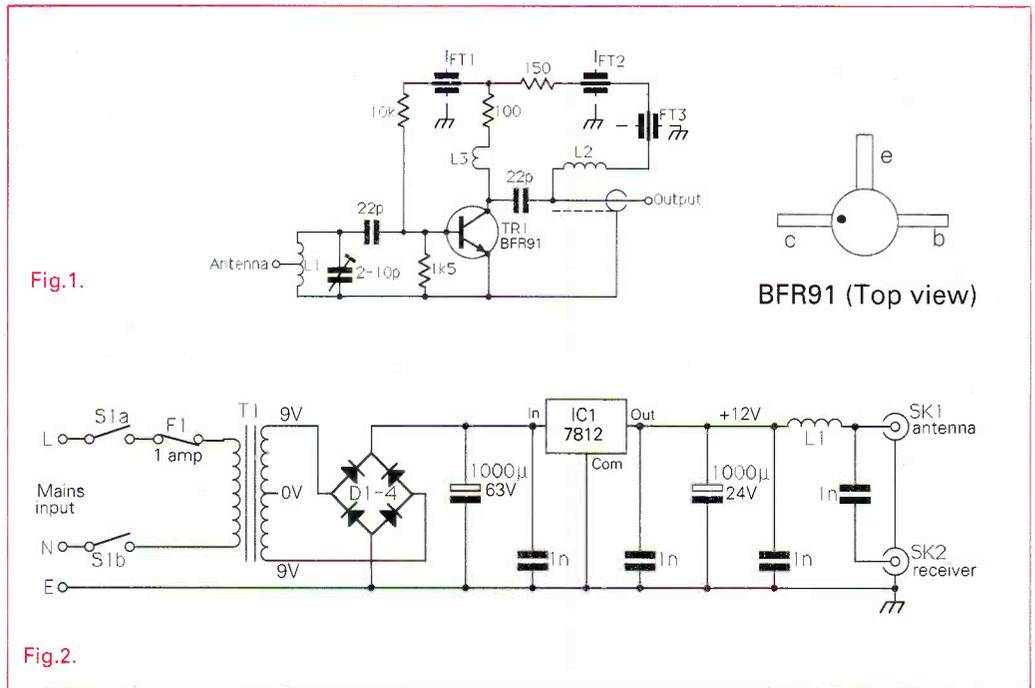

Fig. 1.

Fig. 2.

BFR91 (Top view)



## INNER ANTENNA

connection from the antenna element.

The output connection is via the coaxial cable, this having been brought through the insulator cap with about 1m left to facilitate connection to a downfeeder via Belling Lee connectors. If the exact downfeeder (plus an extra 1m) length is known, then the complete cable can be attached, remembering to thread the cap on first! The braid of the coaxial is twisted and soldered to the p.c.b. to make a very strong mechanical and sound electrical joint. The cable access hole in the insulator cap should be opened up to allow the cable to fit easily.

The amplifier uses a simple, grounded emitter BFR91 with input tuning to improve noise matching and give a basic, selective input circuit. A voltage gain of 12-14dB should be attained at under 2dB noise. Construct the amplifier close to the 20s.w.g. wire connection access hole, above the p.c.b. using normal u.h.f. techniques. Components should be physically as small as possible and the lead lengths kept as short as practical. Make sure that the component leads do not short out to the ground plane.

Power is provided via the coaxial downfeed and a simple p.s.u. is shown in Fig.

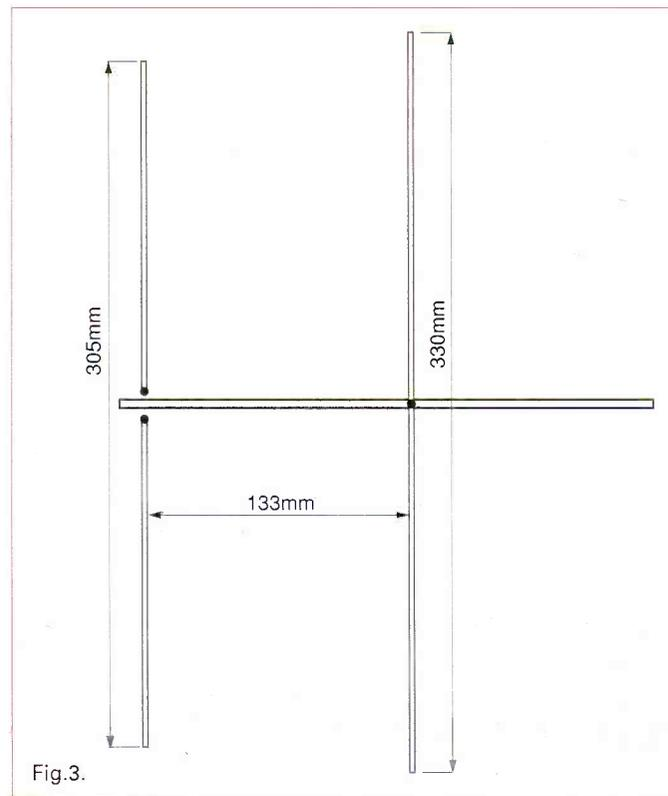

2, although a commercial 12V supply, e.g. Labgear CM7061, with positive to the inner conductor, can be used.

Alignment is simple and best carried out indoors before ascending to the heights. Tune your TV to below Ch. 21 (if you can tune down to 430MHz ATV find the mid point between Ch. 21 and 430MHz ATV) or tune a receiver to approx 455MHz. Locate a steady signal or generate one yourself, adjust the input trimmer to peak the signal (it's very broad in tuning). If it doesn't peak, check that the amplifier is

drawing around 5mA, voltages are correct and that the local Group A TV signals are passing through it with a degree of amplification. If it peaks with minimum capacitance slightly shorten the input tuning line, if with maximum capacitance then increase the tuning line length (L1).

### Results

Results from the active antenna are excellent with signal reception from Portsmouth some 40km to the south-east from main base units. At 16km both

base and hand-helds should be clearly received. For the local radio broadcast links reception may be difficult due to directional antennas unless the 'beam' is in your own basic direction.

Amplification should present no problem unless a base station is next door to you which when operational could result in overloading of the scanner itself - certain scanners are prone to overload - then again, if you live next to a depot of guardians of the law, you'd be very unwise to erect an external 450MHz array!

Power supplies for masthead powering at 12V are made by Labgear, Antiference, Fringe to name but three. A good antenna supply company, such as Aerial Techniques, 11 Kent Road, Parkstone, Poole, Dorset BH12 2EH, (catalogue at 75p), can offer such units.

### Finally

Antenna insulators can be obtained as scrap from your friendly neighbourhood antenna erector à la antique Band I systems - you could of course use an old Band III antenna for this project and cut it down, particularly if an amplifier isn't being constructed within, as there's not much room inside Band III antenna insulators.

## YOU WILL NEED

### Amplifier

Resistors  
5% 0.25W carbon film  
100Ω 1  
150Ω 1  
1.5kΩ 1  
10kΩ 1

Capacitors  
Min. ceramic plate  
22pF 2

Min. trimmer  
2-20pF 1

Feed-through  
1nF 2 FT1,2

### Semiconductors

Transistor  
BFR91 1 TR1

### Inductors

L1 1.5t tap 0.75t, 5mm dia. (25mm of 20s.w.g. tinned copper wire).  
L2 10t, 4mm dia. close

spaced (26s.w.g. e.c.c.w.).  
L3 2t, 4mm dia. (lead-out wire of 100Ω resistor).

### Miscellaneous

Single-sided p.c.b. material.

# Waters & Stanton 0702 206835

FAST MAIL ORDER or 204965

## The One Accessory You Can't Do Without!

### £5.95! + £1 p&p Dispatch by return!

'The Complete VHF/UHF Frequency Guide'  
Revised 1990 - 1991 Edition:

The only publication of its kind, this book is an essential reference for every scanning receiver owner. Prepared from official frequency allocation listings, it provides comprehensive and clearly laid out listings throughout the range 25-2250MHz. Used by professional bodies and amateur enthusiasts alike. It is an essential desk top reference manual for all those involved in radio. Indeed, even if you have not yet purchased a scanning receiver its contents will provide a valuable guide to the frequency ranges your scanner needs in order to cover the services that interest you.

Information is provided regarding the types of service, simplex and duplex frequencies, shipping, coastguards, emergency services, land mobiles, military and civil air lists, amateur radio beacons and repeaters, radio telephones and much more.

Other Titles:

Short Wave Listener's Confidential Frequency List ..... £8.95  
VHF/UHF Airband Frequency Guide ..... £5.95  
HF Oceanic Airband Frequency Guide ..... £3.50  
Marine Frequency Guide ..... £4.95  
Secret of Learning Morse Code ..... £4.95

Post £1 each,  
max £2.

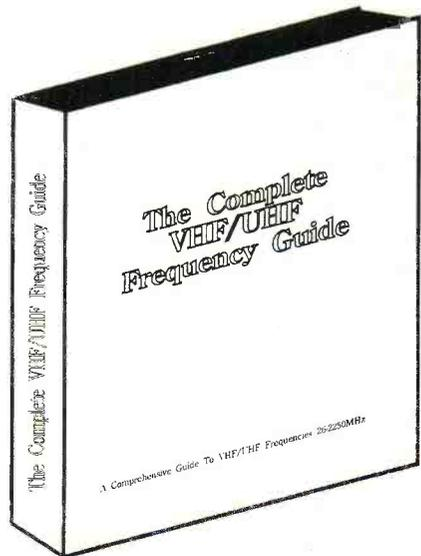

18-20 Main Road, Hockley, Essex SS5 4QS  
Visa or Access by phone - (0702) 206835/204965



# C.M.HOWES COMMUNICATIONS

Mail order to: EYDON, DAVENTRY  
NORTHANTS NN11 6PT  
Tel: 0327 60178



## NEW! ACTIVE ANTENNA FOR SCANNERS

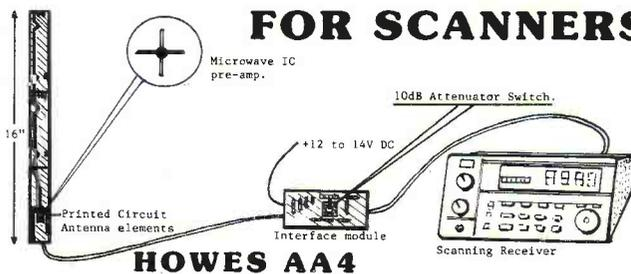

The new **HOWES AA4** Active antenna gives full coverage from 25 to 1300MHz. It is designed to be the ideal solution for those requiring a compact, broadband antenna for use with scanning receivers. The AA4 features advanced technology with a low noise microwave IC as the active element.

- \* Fully broad-band covering 25 to 1300MHz
- \* Low noise microwave IC (NF <3dB). Over 15dB gain.
- \* Third order intercept +15dBm at 500MHz.
- \* Coax powering 12 to 14V DC at less than 20mA.
- \* 10dB switched attenuator on the receiver interface board.
- \* Antenna elements ready formed on printer circuits for easy construction. Size approx 16 inches long, 1.2 inches wide.
- \* Easy to build kit, or ready built modules.

If your scanner reception could benefit from the addition of a remotely located broad-band antenna with built in pre-amplifier, or you would like a much neater, more compact alternative to the large, ugly discone types, then the HOWES AA4 could be just the job! Excellent performance in a small space!

**AA4 kit: £18.80**

**Assembled PCB modules: £24.90**

### AA2 ACTIVE ANTENNA for 150kHz to 30MHz.

The **HOWES AA2** is the active antenna to use with a general coverage HF receiver. Broad-band performance that does not tail off at the higher frequencies. The neat compact answer for those with limited space, holiday use, mobile operation etc. Two selectable gain settings, local or coax powering (12 to 14V), easy to build, and much liked by customers!

**AA2 kit: £7.50**

**Assembled PCB module: £11.50**

### HOWES RECEIVER KITS

We produce a range of easy to build receiver kits which offer a level of performance which is quite amazing for their simplicity. Amateur stations from all over the World can be heard with our **DXR10 three band receiver**. In fact you would be hard pressed to hear any more SSB and CW stations on these bands with even the most expensive sets!

All our receivers have plenty of audio output to drive a loudspeaker, and operate from 12 to 14V DC. There is a full range of accessory kits, these include extra filters, 'S meter', and digital readout. We also have companion transmitter kits for all our amateur band receivers, so you can convert you receiver into a transceiver at a later date.

To make things easy for the constructor we have optional **hardware packages** (case, dial, knobs, sockets etc.) to go with our receiver kits (which contain the electronics).

	KIT	ASSEMBLED PCB	
<b>DXR10</b>	SSB and CW receiver for 10, 12 & 15m bands	<b>£24.90</b>	<b>£36.90</b>
<b>DcRx</b>	Single band receiver for 20/30, 40 or 80m	<b>£15.60</b>	<b>£21.50</b>
<b>DcRx54</b>	5.4MHz HF Airband receiver	<b>£15.60</b>	<b>£21.50</b>
<b>MBRX</b>	HF Marine band receiver, inc. 80 & 160m	<b>£29.90</b>	<b>£44.90</b>
<b>TRF3</b>	Shortwave Broadcast TRF receiver	<b>£14.80</b>	<b>£20.20</b>
<b>DCS2</b>	'S meter' kit for all our receivers	<b>£7.90</b>	<b>£11.90</b>
<b>CSL4</b>	Sharp SSB and CW filters for our receivers	<b>£9.90</b>	<b>£15.90</b>
<b>ASL5</b>	Sharp SSB and CW filter for FRG7, R1000 etc	<b>£14.90</b>	<b>£22.50</b>
<b>CTU30</b>	HF bands & 6M ATU for any RX or 30W TX	<b>£27.90</b>	<b>£33.90</b>

**DXR10 or TRF3 Hardware package: £14.00. DcRx hardware: £15.50**  
**MBRX hardware: £26.00**

Please add **£1.00 P&P** to your total order value.

There are many more kits in our range. Please send a good size SAE for a copy of our free catalogue. Sales and technical advice are available by phone during office hours - you can actually speak to people who know what they are talking about!

All **HOWES KITS** contain a good quality printed circuit board with screen printed parts locations, full instructions and all board mounted components. Our kits offer the challenge and satisfaction of home construction, with the reassurance of help if you need it.

**73 from Dave G4KQH, Technical Manager**

# WHAT SCANNER

## Realistic PRO-38

**TYPE:** hand-held  
**COVERAGE:** 68-88, 136-174, 406-512MHz  
**MODES:** f.m.  
**SENSITIVITY:** 68-88MHz = 0.5µV normal, 2µV limit; 136-174MHz = 0.7µV normal, 3µV limit; 406-512MHz = 0.7µV normal, 4µV limit  
**SELECTIVITY:** At 155MHz -6dB = ±10kHz, -50dB = ±17kHz  
**RESOLUTION:**  
**IMAGE REJECTION:**  
**IF STAGE:**  
**AUDIO OUTPUT:** nominal 260mW  
**SCAN RATE:** 10 channels per second  
**SEARCH RATE:**  
**MEMORIES:** 10  
**FEATURES:** Keyboard lock switch, i.c.d. channel readout, jack for earphone, belt clip and flexible antenna supplied.  
**REVIEWED:** Short Wave Magazine October 1988 (£1.85 back issue)  
**PRICE:** £129.95

## Uniden Bearcat 50XL

**TYPE:** hand-held  
**COVERAGE:** 29-54, 136-174, 406-512MHz  
**MODES:** a.m., f.m.  
**SENSITIVITY:** 29-54MHz = 0.4µV, 136-174MHz = 0.5µV, 406-512MHz = 0.7µV for 12dB SINAD  
**SELECTIVITY:** -55dB @ ±25kHz  
**RESOLUTION:** 5kHz  
**IMAGE REJECTION:** -50dB  
**IF STAGE:** 10.8MHz  
**AUDIO OUTPUT:** 500mW at 10% t.h.d. in 8Ω  
**SCAN RATE:** 15 channels per second  
**SEARCH RATE:** 15 channels per second  
**MEMORIES:** 10  
**FEATURES:**  
**REVIEWED:**  
**PRICE:** £99.99

## AOR AR-2002

**TYPE:** base/mobile station  
**COVERAGE:** 25-550, 800-1300MHz  
**MODES:** a.m., n.b.f.m., w.b.f.m.  
**SENSITIVITY:** n.b.f.m. = 0.3µV, w.b.f.m. = 1.0µV both @ 12dB SINAD; a.m. = 0.5µV @ 10dB S/N  
**SELECTIVITY:** n.b.f.m. ±7.5kHz @ 6dB, w.b.f.m. ±250kHz @ 60dB, a.m. = ±10kHz @ 70dB  
**RESOLUTION:** 5, 12.5, 25kHz  
**IMAGE REJECTION:** -50dB  
**IF STAGE:** 750, 45.03MHz (w.b.f.m.), 455kHz (n.b.f.m./a.m.)  
**AUDIO OUTPUT:** 1W @ <10% distortion  
**SCAN RATE:** 5 channels per second  
**SEARCH RATE:** 6 seconds per MHz  
**MEMORIES:** 20  
**FEATURES:** Tuning knob plus keypad, real-time clock, computer control facilities  
**REVIEWED:** Practical Wireless December 1985 (85p photocopy)  
**PRICE:** £487.30

## Revco RS-2000E

**TYPE:** base station  
**COVERAGE:** 60-179, 380-520MHz  
**MODES:** a.m., f.m.  
**SENSITIVITY:** v.h.f. f.m. = 0.5µV, u.h.f. f.m. = 1.0µV  
**SELECTIVITY:** -60dB @ ±25kHz  
**RESOLUTION:** 5, 12.5 or 50kHz  
**IMAGE REJECTION:**  
**IF STAGE:**  
**AUDIO OUTPUT:** 2W  
**SCAN RATE:** 5 or 10 channels per second  
**SEARCH RATE:** 5 or 10 channels per second  
**MEMORIES:** 70  
**FEATURES:** Auto search and store  
**REVIEWED:**  
**PRICE:** £279

## JIL SX-200N

**TYPE:** mobile/base station  
**COVERAGE:** 26-98, 108-190, 380-514MHz  
**MODES:** a.m., n.b.f.m.  
**SENSITIVITY:** f.m. => 60dB @ ±25kHz, a.m. => 80dB at ±10kHz  
**SELECTIVITY:** 26-180MHz f.m. = 0.4µV, 380-514MHz = 1.0µV both at 12dB S/N, 26-180MHz a.m. = 1.0µV at 10dB S/N, 380-514MHz a.m. = 2.0µV S/N  
**RESOLUTION:** 5, 12.5kHz  
**IMAGE REJECTION:**  
**IF STAGE:** 10.7MHz, 455kHz  
**AUDIO OUTPUT:** 2W  
**SCAN RATE:** 4 or 8 channels per second  
**SEARCH RATE:** 5 or 10 channels per second  
**MEMORIES:** 16  
**FEATURES:**  
**REVIEWED:** Practical Wireless October 1981 (£1.65 back issue)  
**PRICE:** £325



## Yaesu FRG-9600

**TYPE:** base station  
**COVERAGE:** 60-905MHz (up to 460MHz for s.s.b.)  
**MODES:** n.b.f.m., w.b.f.m., n.b.a.m., w.b.a.m., s.s.b.  
**SENSITIVITY:** n.b.f.m. = 0.5µV, w.b.f.m. = 1.0µV both @ 12dB SINAD, n.b.a.m. = 1.0µV, w.b.a.m. = 1.5µV both @ 10dB S/N, s.s.b. = 1.0µV @ 15dB S/N  
**SELECTIVITY:** n.b.f.m. ±15kHz, w.b.f.m. ±180kHz, n.b.a.m. ±2.4kHz, w.b.a.m. ±6kHz, s.s.b. ±2.4kHz all @ 3dB  
**RESOLUTION:** 100Hz, 1, 5, 10, 12.5, 25 or 100kHz depending on mode  
**IMAGE REJECTION:** 60-460MHz = -50dB, 460-905MHz = -40dB  
**IF STAGE:** 45.754, 10.5MHz & 455kHz  
**AUDIO OUTPUT:** 1W into 8Ω with less than 10% t.h.d.  
**SCAN RATE:** not given  
**SEARCH RATE:**  
**MEMORIES:** 100  
**FEATURES:** 0.6m whip antenna, 1.8m d.c. power cable, mobile mounting bracket & wire stand.  
**REVIEWED:**  
**PRICE:** £520

## Realistic PRO-32A

**TYPE:** hand-held  
**COVERAGE:** 68-88, 108-136 (a.m.), 136-174, 380-512MHz  
**MODES:** a.m., f.m.  
**SENSITIVITY:** 68-88MHz = 0.6µV, 136-174MHz & 380-512MHz = 1.0µV f.m. 20dB S/N at 3kHz deviation; 108-136MHz = 2µV a.m. 20dB S/N at 60% modulation  
**SELECTIVITY:** -6dB @ ±9kHz, -60dB @ ±15MHz  
**RESOLUTION:** 5, 12.5 or 25kHz  
**IMAGE REJECTION:**  
**IF STAGE:** 455kHz, 10.7MHz  
**AUDIO OUTPUT:** 300mW  
**SCAN RATE:** 4 or 8 channels per second  
**SEARCH RATE:** 4 or 8 channels per second  
**MEMORIES:** 200  
**FEATURES:** lockout, delay and priority channel, helical antenna.  
**REVIEWED:** Short Wave Magazine November 1987 (£1.65 back issue)  
**PRICE:** £239.95

## JIL SX-400

**TYPE:** base station  
**COVERAGE:** 26-520MHz (100kHz-1.4GHz with converters)  
**MODES:** a.m., n.b.f.m., w.b.f.m.  
**SENSITIVITY:** v.h.f. f.m. = 0.5µV, u.h.f. f.m. = 0.5µV both @ 12dB S/N, v.h.f. a.m. = 1.0µV, u.h.f. a.m. = 2.0µV both @ 10dB S/N  
**SELECTIVITY:** f.m. = 60dB @ ±15kHz, a.m. = 60dB @ ±10kHz both with S/N 45dB  
**RESOLUTION:** 5, 6.25, 10, 12.5kHz  
**IMAGE REJECTION:** v.h.f. = 50dB  
**IF STAGE:** 10.7MHz, 455kHz  
**AUDIO OUTPUT:** 2W into 4Ω load  
**SCAN RATE:** 4 or 8 channels per second  
**SEARCH RATE:** 5 and 10 channels per second  
**MEMORIES:** 20  
**FEATURES:**  
**REVIEWED:**  
**PRICE:** £650



## Regency HX850E

**TYPE:** hand-held  
**COVERAGE:** 75-106 or 60-90, 118-175, 406-496MHz  
**MODES:** a.m., n.b.f.m.  
**SENSITIVITY:** v.h.f. f.m. = 0.7µV, u.h.f. f.m. = 1.0µV both @ 12dB SINAD, v.h.f. a.m. = 1.0µV @ 10dB S/N  
**SELECTIVITY:** f.m./a.m. ±7.5kHz @ 6dB  
**RESOLUTION:** 5, 10 & 12.5kHz

## Uniden Bearcat 70XLT

**TYPE:** hand-held  
**COVERAGE:** 29-54, 136-174, 406-512MHz  
**MODES:** f.m., a.m.  
**SENSITIVITY:** 29-54MHz = 0.4µV, 136-174MHz = 0.5µV, 406-512MHz = 0.7µV  
**SELECTIVITY:** -55dB @ ±25kHz  
**RESOLUTION:** 5kHz  
**IMAGE REJECTION:** -50dB  
**IF STAGE:** 10.8MHz  
**AUDIO OUTPUT:** 140mW at 10% t.h.d. into 8Ω  
**SCAN RATE:** 15 channels per second  
**SEARCH RATE:** 15 channels per second  
**MEMORIES:** 20  
**FEATURES:**  
**REVIEWED:**  
**PRICE:** £199.99



**MEMORIES:** 20  
**FEATURES:**  
**REVIEWED:** Practical Wireless May 1984 (£1.65 back issue)  
**PRICE:** Available second-hand

## Realistic PRO-2004

**TYPE:** base/mobile station  
**COVERAGE:** 25-520, 760-1300MHz  
**MODES:** a.m., w.b.f.m., n.b.f.m.  
**SENSITIVITY:** w.b.f.m. 25-520 & 760-1100MHz = 3µV, 1100-1300MHz = 10µV all @ 30dB S/N @ 22.5kHz n.b.f.m. 25-520MHz = 0.5µV, 760-1300MHz = 0.3µV all at 20dB S/N @ 3kHz dev. a.m. 25-520 & 760-1100MHz = 2µV, 1100-1300MHz = 3µV all at 20dB S/N @ 60%  
**SELECTIVITY:** n.b.f.m. & a.m. ±9kHz @ -6dB, ±15kHz @ -50dB, w.b.f.m. ±150kHz @ -6dB, ±300kHz @ -50dB  
**RESOLUTION:** 5, 12.5 or 50kHz  
**IMAGE REJECTION:** -60dB  
**IF STAGE:** 611.5-607.505MHz, 48.5MHz, 455kHz (a.m.)  
**AUDIO OUTPUT:** 1.8W @ 3% t.h.d.  
**SCAN RATE:** 8 or 16 steps per second  
**SEARCH RATE:** 8 or 16 steps per second  
**MEMORIES:** 300  
**FEATURES:** Lock-out key, squelch, priority function key and large i.c.d. read-out  
**REVIEWED:** Short Wave Magazine April 1987 (£1.65 back issue)  
**PRICE:** £329.95

## Uniden Bearcat UBC-175XL

**TYPE:** base station  
**COVERAGE:** 66-88, 118-174, 406-512MHz  
**MODES:** a.m., f.m.  
**SENSITIVITY:** 29-54 & 136-174MHz = 0.3µV, 406-512MHz = 0.5µV, 118-136MHz = 0.8µV @ 12dB SINAD  
**SELECTIVITY:** -45dB @ ±25kHz  
**RESOLUTION:** 5kHz  
**IMAGE REJECTION:** -55dB  
**IF STAGE:** 10.8MHz, 450kHz  
**AUDIO OUTPUT:** 800mW @ 10% t.h.d.  
**SCAN RATE:** 5 or 15 channels per second  
**SEARCH RATE:** 5 or 15 channels per second  
**MEMORIES:** 16  
**FEATURES:** priority scan, channel lockout, auto squelch, short term memory back-up, wood veneer case  
**REVIEWED:** Short Wave Magazine December 1987 (£1.65 back issue)  
**PRICE:** £169.99



## Uniden Bearcat 100XL

**TYPE:** hand-held  
**COVERAGE:** 66-88, 118-174, 406-512MHz  
**MODES:** a.m., f.m.  
**SENSITIVITY:** 30-50MHz = 0.3µV, 118-136MHz = 0.8µV, 136-174MHz = 0.4µV, 406-512MHz = 0.5µV for 12dB SINAD  
**SELECTIVITY:** 50dB at ±25kHz  
**RESOLUTION:** 5kHz  
**IMAGE REJECTION:** -50dB  
**IF STAGE:** 10.8MHz  
**AUDIO OUTPUT:** 300mW at 10% t.h.d.  
**SCAN RATE:** 15 channels per second  
**SEARCH RATE:** 25 frequencies per second  
**MEMORIES:** 16  
**FEATURES:** Priority channel, keyboard lock, auto squelch, battery low indicator, back-lit display  
**REVIEWED:**  
**PRICE:** £189.99

# WHAT SCANNER

## Black Jaguar BJ200 Mark III

**TYPE:** hand-held  
**COVERAGE:** 26-30, 50-88, 115-178, 210-280, 360-520MHz  
**MODES:** a.m., f.m.  
**SENSITIVITY:** f.m. = 0.5µV for h.f. & v.h.f. & 0.7µV for u.h.f. all 12dB SINAD; a.m. = 1.0µV for h.f. & v.h.f., 1.5µV for u.h.f. all 10dB SINAD  
**SELECTIVITY:** 60dB @ 20kHz  
**RESOLUTION:** 5, 10, 12.5kHz  
**IMAGE REJECTION:** more than 40dB  
**IF STAGE:**  
**AUDIO OUTPUT:** 250mW into 8Ω  
**SCAN RATE:** 10 channels per second  
**SEARCH RATE:**  
**MEMORIES:** 16  
**FEATURES:** priority and memory lockout on scan, selectable a.m./f.m.  
**REVIEWED:** What Scanner Autumn 1990 (with SWM)  
**PRICE:** £235.00

## WIN 108

**TYPE:** hand-held  
**COVERAGE:** 108-135.975MHz  
**MODES:** a.m.  
**SENSITIVITY:** 0.5µV @ 12dB SINAD  
**SELECTIVITY:** -59dB @ 25kHz  
**RESOLUTION:** 25, 50kHz  
**IMAGE REJECTION:** -55dB  
**IF STAGE:** 10.7MHz, 455kHz  
**AUDIO OUTPUT:** 320mW at 10% t.h.d.  
**SCAN RATE:** 10 channels per second  
**SEARCH RATE:** 5 seconds per MHz at 25kHz steps  
**MEMORIES:** 20  
**FEATURES:** priority channel, display/hold, channel lockout, keyboard lock, external power and speaker jacks, display lighting  
**REVIEWED:** Short Wave Magazine December 1988 (£1.65 back issue)  
**PRICE:** £175.00

## Uniden Bearcat 580XLT

**TYPE:** mobile/base station  
**COVERAGE:** 29-54, 118-174, 406-512MHz  
**MODES:** a.m., f.m.  
**SENSITIVITY:** h.f. & v.h.f. = 0.4µV, u.h.f. = 0.5µV all @ 12dB SINAD  
**SELECTIVITY:** -55dB @ 25MHz  
**RESOLUTION:** 5, 10, 12.5kHz  
**IMAGE REJECTION:**  
**IF STAGE:**  
**AUDIO OUTPUT:** 2.5W @ 10% t.h.d.  
**SCAN RATE:** 15 channels per second  
**SEARCH RATE:**  
**MEMORIES:** 100  
**FEATURES:** 2 second delay, lockout, priority scan  
**REVIEWED:**  
**PRICE:** £199.00

## Sony AIR-7

**TYPE:** hand-held  
**COVERAGE:** 150kHz-2.19MHz, 76-136, 144-174MHz  
**MODES:** a.m., w.b.f.m., n.b.f.m.  
**SENSITIVITY:** f.m. = 2µV @ 20dB S/N, airband = 1.25µV @ 12dB SINAD, 144-174MHz = 0.5µV @ 12dB SINAD  
**SELECTIVITY:**  
**RESOLUTION:** 5, 9, 10, 25 or 50kHz  
**IMAGE REJECTION:**  
**IF STAGE:**  
**AUDIO OUTPUT:** 400mW into 8Ω  
**SCAN RATE:**  
**SEARCH RATE:**  
**MEMORIES:** 10  
**FEATURES:** key protect, backlit l.c.d. readout, priority channel  
**REVIEWED:** Practical Wireless November 1986 (85p photocopy)  
**PRICE:** £247

## Revco RS-3000

**TYPE:** base station  
**COVERAGE:** 26-32, 60-90, 118-180, 380-512MHz  
**MODES:** a.m., n.b.f.m.  
**SENSITIVITY:** v.h.f. & h.f. = 0.5µV, airband & u.h.f. = 1µV both 10dB S/N  
**SELECTIVITY:**  
**RESOLUTION:** 5, 12.5, 25kHz  
**IMAGE REJECTION:**  
**IF STAGE:** 21.4MHz, 455kHz  
**AUDIO OUTPUT:** 1.5W @ 10% t.h.d.  
**SCAN RATE:**  
**SEARCH RATE:**  
**MEMORIES:** 50  
**FEATURES:** compact size, l.c.d. readout, priority memory channel  
**REVIEWED:** Short Wave Magazine June 1988 (£1.60 back issue)  
**PRICE:** £199.00

## Realistic PRO-2021

**TYPE:** base/mobile  
**COVERAGE:** 68-88, 108-136, 138-174, 380-512MHz  
**MODES:** a.m., f.m.  
**SENSITIVITY:** 66-88MHz, 138-174MHz & 380-512MHz = 1µV, 108-136MHz = 2µV  
**SELECTIVITY:** -6dB @ ±3kHz, -50dB @ ±15kHz  
**RESOLUTION:** 5, 12.5 & 25kHz  
**IMAGE REJECTION:**  
**IF STAGE:** 10.7MHz, 455kHz  
**AUDIO OUTPUT:** 300mW  
**SCAN RATE:** 4 or 8 channels per second  
**SEARCH RATE:**  
**MEMORIES:** 200  
**FEATURES:** Squelch control, mobile mounting bracket included, sockets for external antenna, speaker and tape socket  
**REVIEWED:** Short Wave Magazine August 1988 (85p photocopy)  
**PRICE:** £219.95

## AOR AR800E

**TYPE:** hand-held  
**COVERAGE:** 75-105, 118-136, 140-174, 406-495, 830-950MHz  
**MODES:** a.m., f.m.  
**SENSITIVITY:** 75-105, 118-136 & 140-174MHz = 0.4µV, 406-495MHz = 0.5µV, 830-950MHz = 1µV all @ 12dB SINAD, 118-136MHz a.m. = 0.8µV @ 10dB S/N  
**SELECTIVITY:** -23dB @ ±12.5kHz, -45dB @ ±25kHz  
**RESOLUTION:** 5, 10, 12.5kHz (v.h.f.), 12.5kHz (u.h.f.), 25kHz (offset by 12.5kHz) on 830-950MHz  
**IMAGE REJECTION:** -24dB @ 145MHz  
**IF STAGE:** 21.4MHz, 455kHz  
**AUDIO OUTPUT:** 140mW at 10% t.h.d.  
**SCAN RATE:** 13 channels per second  
**SEARCH RATE:** 7.5 seconds per MHz at 12.5kHz steps  
**MEMORIES:** 20  
**FEATURES:** NiCad battery pack and charger supplied, two helical antennas, illuminated l.c.d. readout and delay/hold function  
**REVIEWED:**  
**PRICE:** £199.00

## Kenwood RZ-1

**TYPE:** base/mobile station  
**COVERAGE:** 500kHz-905MHz  
**MODES:** a.m., n.b.f.m., w.b.f.m.  
**SENSITIVITY:** a.m. = 5µV @ 10dB S/N, n.b.f.m. = 6µV @ 12dB SINAD, 60-905MHz = 3µV, w.b.f.m. = 1µV  
**SELECTIVITY:**  
**RESOLUTION:** 5, 12.5, 20, 25kHz  
**IMAGE REJECTION:**  
**IF STAGE:** 45.75, 10.7MHz  
**AUDIO OUTPUT:** 2W into 8Ω @ 5% t.h.d.  
**SCAN RATE:**  
**SEARCH RATE:**  
**MEMORIES:** 100  
**FEATURES:** text store feature, picture symbols available on display  
**REVIEWED:** Short Wave Magazine April 1988 (£1.65 back issue)  
**PRICE:** £465

## Sony ICF PRO-80

**TYPE:** hand-held  
**COVERAGE:** 150kHz-108MHz (115.15kHz - 223MHz using FRG-80 converter)  
**MODES:** w.b.a.m., n.b.a.m., f.m., n.b.f.m., s.s.b.  
**SENSITIVITY:** f.m. & m.w. = 420µV, f.m. = 90µV/30dB S/N  
**SELECTIVITY:** ±3.8kHz @ 50dB, ±400kHz @ 50dB for f.m.  
**RESOLUTION:** 3, 5, 10, 50kHz plus fine tune  
**IMAGE REJECTION:** 77dB (l.w., m.w., s.w., v.h.f.), 40dB (f.m.)  
**IF STAGE:** 55.845MHz, 455kHz, 10.7MHz (f.m.)  
**AUDIO OUTPUT:** 400mW at 10% t.h.d.  
**SCAN RATE:**  
**SEARCH RATE:**  
**MEMORIES:** 40  
**FEATURES:** converter supplied, soft case, shoulder belt, frequency handbook, key protect facility, fine tune control  
**REVIEWED:** Short Wave Magazine March 1988 (£1.65 back issue)  
**PRICE:** £235.00

## Signal R-535

**TYPE:** base station  
**COVERAGE:** 108-142.995, 220-379.995MHz  
**MODES:** a.m.  
**SENSITIVITY:** v.h.f. = 0.32µV, u.h.f. = 0.46µV both for 12dB SINAD  
**SELECTIVITY:** ±25kHz @ 55dB  
**RESOLUTION:** 5, 10, 25, 50, 100kHz (v.h.f.); 25, 50, 100, 500kHz, 1MHz (u.h.f.)  
**IMAGE REJECTION:** v.h.f. = >55dB, u.h.f. = >25dB  
**IF STAGE:** 21.4MHz, 455kHz  
**AUDIO OUTPUT:** 360mW into 8Ω  
**SCAN RATE:** 12 channels per second  
**SEARCH RATE:** 2.5 seconds per MHz in 25kHz steps  
**MEMORIES:** 60  
**FEATURES:** connection of RS232 interface possible and portable operation available  
**REVIEWED:**  
**PRICE:** £249

## Uniden Bearcat 100XLT

**TYPE:** hand-held  
**COVERAGE:** 29-54, 118-174, 406-512MHz  
**MODES:** a.m., f.m.  
**SENSITIVITY:** h.f. = 0.4µV, v.h.f. = 0.8µV, u.h.f. = 0.5µV  
**SELECTIVITY:** ±25kHz @ 55dB  
**RESOLUTION:** 5, 10, 12.5kHz  
**IMAGE REJECTION:**  
**IF STAGE:**  
**AUDIO OUTPUT:** 480mW  
**SCAN RATE:** 15 channels per second  
**SEARCH RATE:** 25 frequencies per second  
**MEMORIES:** 100  
**FEATURES:** antenna, earpiece, a.c. adapter included  
**REVIEWED:**  
**PRICE:** £225.00

## Bearcat 210XW

**TYPE:**  
**COVERAGE:** 30-50, 136-174, 406-512MHz  
**MODES:** f.m.  
**SENSITIVITY:** 30-50 & 136-174MHz = 0.3µV, 406-512MHz = 0.5µV  
**SELECTIVITY:** ±25kHz @ 55dB  
**RESOLUTION:** 5kHz  
**IMAGE REJECTION:**  
**IF STAGE:**  
**AUDIO OUTPUT:** 1.5W r.m.s. into 8Ω @ 10% t.h.d.  
**SCAN RATE:**  
**SEARCH RATE:**  
**MEMORIES:** 20  
**FEATURES:** readout facility, delay function, telescopic antenna supplied  
**REVIEWED:**  
**PRICE:** £169

## Bearcat 800XLT

**TYPE:** mobile/base station  
**COVERAGE:** 29-54, 118-174, 406-512, 806-912MHz  
**MODES:** f.m.  
**SENSITIVITY:** 29-54 & 136-174MHz = 0.3µV, 118-136MHz = 0.8µV, 406-512MHz = 0.5µV, 806-912MHz = 0.7µV  
**SELECTIVITY:** -55dB @ ±25kHz  
**RESOLUTION:** 5, 12.5, 25kHz  
**IMAGE REJECTION:**  
**IF STAGE:**  
**AUDIO OUTPUT:** 1.5W @ 10% t.h.d.  
**SCAN RATE:** 15 channels per second (rapid)  
**SEARCH RATE:** 15 frequencies per second  
**MEMORIES:** 40  
**FEATURES:** priority channel, scan delay, direct channel access and channel lockout  
**REVIEWED:** Short Wave Magazine March 1989 (£1.65 back issue)  
**PRICE:** £257

## Icom IC-R1



**TYPE:** hand-held  
**COVERAGE:** 100kHz-1.3GHz  
**MODES:** a.m., n.b.f.m., w.b.f.m.  
**SENSITIVITY:** a.m. = 1.6µV (2-25MHz) 0.79µV (25-905MHz) for 10dB S/N; n.b.f.m. = 0.79µV (2-25MHz) 0.4µV (25-905MHz) w.b.f.m. = 6.3µV (2-25MHz) 3.16µV (25-905MHz) for 12dB SINAD  
**SELECTIVITY:** a.m. more than 15kHz/-6dB, n.b.f.m. more than 15kHz/-6dB, w.b.f.m. more than 150kHz/-6dB  
**RESOLUTION:** 0.5, 5, 8, 9, 10, 12.5, 15, 20, 25, 30 or 50kHz  
**IMAGE REJECTION:**  
**IF STAGE:** 266.7000-266.7095MHz, 10.7MHz, 455kHz  
**AUDIO OUTPUT:** 150mW @ 10% t.h.d.  
**SCAN RATE:**  
**SEARCH RATE:**  
**MEMORIES:** 100  
**FEATURES:** multi-scan function, built-in S-meter, built-in clock with timer  
**REVIEWED:** Practical Wireless July 1990 (£1.65 back issue)  
**PRICE:** £399.00

## Standard AX700



**TYPE:** base/mobile  
**COVERAGE:** 50-904.995MHz  
**MODES:** a.m., w.b.f.m., n.b.f.m.  
**SENSITIVITY:** a.m. = 3µV @ 10dB S/N, n.b.f.m. = 1.5µV, w.b.f.m. = 1µV both for 12dB SINAD  
**SELECTIVITY:**  
**RESOLUTION:** 1, 5, 10, 12.5, 20, 25kHz  
**IMAGE REJECTION:**  
**IF STAGE:**  
**AUDIO OUTPUT:** more than 1.8W in 8Ω @ 10% t.h.d.  
**SCAN RATE:**  
**SEARCH RATE:**  
**MEMORIES:** 100  
**FEATURES:** telescopic antenna supplied, l.c.d. readout, backlit display, spectral display  
**REVIEWED:**  
**PRICE:** £575.00

# WHAT SCANNER

## Icom IC-R7000HF



**TYPE:** base station  
**COVERAGE:** 25-999.999, 1025-1999.999MHz  
**MODES:** a.m., f.m., s.s.b.  
**SENSITIVITY:** 25-999.999MHz n.b.f.m. >0.5µV, f.m. >1.0µV both for 12dB SINAD; a.m. >1.0µV for 10dB S/N, s.s.b. >0.3µV both for 10dB S/N  
**SELECTIVITY:** f.m., a.m. = 7.5kHz @ -6dB, n.b.f.m. = 3kHz @ -6dB, f.m. 7.5kHz @ -6dB, s.s.b. = 1.4kHz @ -6dB  
**RESOLUTION:** 100kHz min

**IMAGE REJECTION:** <60dB  
**IF STAGE:** 778.7 or 226.7, 10.7MHz, 455kHz  
**AUDIO OUTPUT:** 2.5W  
**SCAN RATE:** 2 or 7 channels per second  
**SEARCH RATE:** not given  
**MEMORIES:** 100  
**FEATURES:**  
**REVIEWED:** Short Wave Magazine December 1989 (£1.65 back issue)  
**PRICE:** £989.00

## Uniden Bearcat UBC200XL

**TYPE:** hand-held  
**COVERAGE:** 66-88, 118-174, 406-512, 806-956MHz  
**MODES:** a.m., f.m.  
**SENSITIVITY:** 66-88 & 406-512MHz = 0.3µV, 118-136 & 806-956MHz = 0.6µV, 136-174MHz = 0.4µV  
**SELECTIVITY:** -55dB @ ±25kHz  
**RESOLUTION:** 5kHz  
**IMAGE REJECTION:**  
**IF STAGE:**  
**AUDIO OUTPUT:** 500mW max  
**SCAN RATE:** 15 channels per second  
**SEARCH RATE:** 25 frequencies per second  
**MEMORIES:** 200  
**FEATURES:** memory back-up, priority scan, l.c.d. readout, lockout  
**REVIEWED:**  
**PRICE:** £229.00

## Fairmate HP-100E MkII

**TYPE:** hand-held  
**COVERAGE:** 8.600, 830-1300MHz  
**MODES:** a.m., n.b.f.m., w.b.f.m.  
**SENSITIVITY:** 8.550, 805-1300MHz less than 0.5µV for 12dB SINAD, 25-550MHz a.m. less than 2µV, w.b.f.m. less than 3µV  
**SELECTIVITY:**  
**RESOLUTION:** 5.995kHz selectable  
**IMAGE REJECTION:**  
**IF STAGE:** 561.225, 58.075MHz, 455kHz  
**AUDIO OUTPUT:** over 100mW for 10% t.h.d.  
**SCAN RATE:** 40 channels per second  
**SEARCH RATE:**  
**MEMORIES:** 1000  
**FEATURES:** NiCads, two antennas, carry case, shoulder strap, belt clip, d.c. cable and earpiece provided  
**REVIEWED:** Short Wave Magazine February 1990 (£1.65 back issue)  
**PRICE:** £299.00

## Bearcat 100FB

**TYPE:** hand-held  
**COVERAGE:** 66-89, 138-174, 406-512MHz  
**MODES:** f.m.  
**SENSITIVITY:** 66-88 & 138-174MHz = 0.6µV, 406-512MHz = 1µV both @ 12dB SINAD  
**SELECTIVITY:** 50dB @ ±25kHz  
**RESOLUTION:** 5 & 12.5kHz  
**IMAGE REJECTION:**  
**IF STAGE:**  
**AUDIO OUTPUT:** 300mW  
**SCAN RATE:** 15 channels per second  
**SEARCH RATE:** 15 channels per second  
**MEMORIES:** 16  
**FEATURES:** low battery warning lamp and lockout facility  
**REVIEWED:** Practical Wireless September 1982 (reprint available @ 85p)  
**PRICE:** £253 when new, now second-hand

## Uniden Bearcat BC590XL

**TYPE:** mobile  
**COVERAGE:** 29-54, 118-174, 406-512MHz  
**MODES:** a.m., f.m.  
**SENSITIVITY:** 29-54 & 136-174MHz = 0.4µV, 118-136MHz = 0.8µV, 406-512MHz = 0.5µV  
**SELECTIVITY:** -55dB @ ±25kHz  
**RESOLUTION:** 5kHz min  
**IMAGE REJECTION:**  
**IF STAGE:**  
**AUDIO OUTPUT:** 2.5W @ 10% t.h.d.  
**SCAN RATE:** 15 channels per second  
**SEARCH RATE:**  
**MEMORIES:** 100  
**FEATURES:** lockout, telescopic antenna included  
**REVIEWED:**  
**PRICE:** £199.00

## ASA AIR PRO II

**TYPE:** hand-held  
**COVERAGE:** 520kHz-1.65MHz, 88-108, 118-136, 162.5MHz  
**MODES:** a.m., f.m.  
**SENSITIVITY:** a.m. = 4.7mV/m @ 20dB SINAD, f.m. = 4µV  
**SELECTIVITY:** a.m. = 10dB, f.m. = 25dB  
**RESOLUTION:**  
**IMAGE REJECTION:** a.m. = 25dB, f.m. = 20dB  
**IF STAGE:**  
**AUDIO OUTPUT:** 170mW  
**SCAN RATE:**  
**SEARCH RATE:**  
**MEMORIES:**  
**FEATURES:** l.c.d. readout, external power supply port  
**REVIEWED:**  
**PRICE:** £59.95

## Icom IC-R9000

**TYPE:** base station  
**COVERAGE:** 100kHz - 1.9998GHz  
**MODES:** a.m., n.b.f.m., w.b.f.m., s.s.b., f.s.k., c.w.  
**SENSITIVITY:** 100-500kHz = 0.5µV s.s.b., c.w., f.s.k. 3.2µV a.m., 500kHz-1.799MHz = 1.0µV a.m. 6.3µV, 1.8-29.999MHz = s.s.b., c.w., f.s.k. 0.16µV a.m. 1.0µV, 30-999.99MHz = s.s.b., c.w., f.s.k. 0.32µV a.m. 1.4µV n.b.f.m. 0.5µV w.b.f.m. 1.4µV, 1-1.2399GHz = s.s.b., c.w., f.s.k. 0.63µV a.m. 4.0µV n.b.f.m. 1.0µV w.b.f.m. 4.0µV, 1.24-1.2999GHz = s.s.b., c.w., f.s.k. 0.32µV a.m. 2.0µV n.b.f.m. 0.5µV w.b.f.m. 2.0µV, 1.3-1.5999GHz = s.s.b., c.w., f.s.k. 0.63µV a.m. 4.0µV n.b.f.m. 1.0µV w.b.f.m. 4.0µV, 1.6-1.9998GHz = s.s.b., c.w., f.s.k. 1.0µV a.m. 5.6µV n.b.f.m. 1.4µV w.b.f.m. 5.6µV  
**SELECTIVITY:** s.s.b., c.w., f.s.k. = more than 2.4kHz/-6dB, a.m. = more than 6kHz/-6dB, n.b.f.m. = more than 15kHz/-6dB, w.b.f.m. = more than 150kHz/-6dB  
**RESOLUTION:** not known  
**IMAGE REJECTION:**  
**IF STAGE:** 48.79376-48.8, 776.60001-778.7, 278.60001-278.7, 10.7MHz, 455kHz  
**AUDIO OUTPUT:** more than 2.5W into 8Ω @ 10% t.h.d.  
**SCAN RATE:**  
**SEARCH RATE:**  
**MEMORIES:**  
**FEATURES:**  
**REVIEWED:** Short Wave Magazine April 1989 (£1.65)  
**PRICE:** £3995.00

## Icom IC-R100

**TYPE:** mobile/base station  
**COVERAGE:** 100kHz-1.8566GHz  
**MODES:** a.m., n.b.f.m., w.b.f.m.  
**SENSITIVITY:** 500kHz-1.8295MHz = a.m. 3.2µV, 1.83-49.9995MHz = a.m. 1.6µV n.b.f.m. 0.56µV, 50-904.9995MHz = a.m. 0.56µV n.b.f.m. 0.2µV w.b.f.m. 0.63µV, 905-1380.4875MHz = a.m. 1.0µV n.b.f.m. 0.32µV w.b.f.m. 0.79µV, 1.3905-1.86GHz = a.m. 1.4µV n.b.f.m. 0.45µV w.b.f.m. 1.1µV  
**SELECTIVITY:** a.m. = more than 6kHz/-6dB, n.b.f.m. = more than 15kHz/-6dB, w.b.f.m. = more than 180kHz/-3dB  
**RESOLUTION:** 1, 5, 8, 10, 12.5, 20, 25kHz  
**IMAGE REJECTION:**  
**IF STAGE:**  
**AUDIO OUTPUT:** more than 2.5W at 10% t.h.d.  
**SCAN RATE:**  
**SEARCH RATE:**  
**MEMORIES:** 100  
**FEATURES:**  
**REVIEWED:**  
**PRICE:** £499

## Fairmate HP-100E MkII



**TYPE:** hand-held  
**COVERAGE:** 8.600, 830-1300MHz  
**MODES:** a.m., n.b.f.m., w.b.f.m.  
**SENSITIVITY:** 8.550, 805-1300MHz less than 0.5µV for 12dB SINAD, 25-550MHz a.m. less than 2µV, w.b.f.m. less than 3µV  
**SELECTIVITY:**  
**RESOLUTION:** 5.995kHz selectable  
**IMAGE REJECTION:**  
**IF STAGE:** 561.225, 58.075MHz, 455kHz  
**AUDIO OUTPUT:** over 100mW for 10% t.h.d.  
**SCAN RATE:** 40 channels per second  
**SEARCH RATE:**  
**MEMORIES:** 1000  
**FEATURES:** NiCads, two antennas, carry case, shoulder strap, belt clip, d.c. cable and earpiece provided  
**REVIEWED:** Short Wave Magazine February 1990 (£1.65 back issue)  
**PRICE:** £299.00

## Uniden Bearcat UBC50XL

**TYPE:** hand-held  
**COVERAGE:** 66-88, 136-174, 406-512MHz  
**MODES:** a.m., f.m.  
**SENSITIVITY:** 66-88MHz = 0.4µV, 136-174 & 406-512MHz = 0.7µV all for 12dB SINAD  
**SELECTIVITY:** -55dB @ ±25kHz  
**RESOLUTION:**  
**IMAGE REJECTION:**  
**IF STAGE:**  
**AUDIO OUTPUT:** 400mW into 8Ω  
**SCAN RATE:** 10 channels per second  
**SEARCH RATE:**  
**MEMORIES:** 10

**FEATURES:** low battery indicator, memory back-up, lockout  
**REVIEWED:**  
**PRICE:** £99.95

## Realistic PRO-2005

**TYPE:** base station  
**COVERAGE:** 25-520, 760-1300MHz  
**MODES:** a.m., n.b.f.m., w.b.f.m.  
**SENSITIVITY:** w.b.f.m. 25-520 & 760-1100MHz = 3µV, 1100-1300MHz = 10µV, n.b.f.m. 25-520 & 760-1100MHz = 0.5µV, 1100-1300MHz = 3µV, a.m. 25-520 & 760-1100MHz  
**SELECTIVITY:** n.b.f.m. & a.m. = ±9kHz -6dB, ±15kHz -50dB, w.b.f.m. = ±150kHz -6dB, ±300kHz -50dB  
**RESOLUTION:** 5kHz min  
**IMAGE REJECTION:** 610MHz @ 70MHz 60dB, 608MHz @ 1000MHz 60dB  
**IF STAGE:**  
**AUDIO OUTPUT:** 1.3W  
**SCAN RATE:** 8 or 16 channels per second  
**SEARCH RATE:** 8 or 16 frequencies per second  
**MEMORIES:** 400 permanent, 10 temporary  
**FEATURES:**  
**REVIEWED:** Short Wave Magazine September 1989 (£1.65 back issue)  
**PRICE:** £339.95

## Regency MX7000

**TYPE:** Base station  
**COVERAGE:** 25-550, 800-1300MHz  
**MODES:** a.m., n.b.f.m., w.b.f.m.  
**SENSITIVITY:** n.b.f.m. = 0.4µV, w.b.f.m. = 1.0µV both @ 12dB SINAD, a.m. = 0.8µV @ 10dB S/N  
**SELECTIVITY:** n.b.f.m. = 7.5kHz, w.b.f.m. = ±5-kHz, a.m. = ±5kHz all @ 6dB  
**RESOLUTION:** 5, 12.5 & 25kHz  
**IMAGE REJECTION:** 50dB  
**IF STAGE:** 750, 45.03, 5.5, 455kHz  
**AUDIO OUTPUT:** 1W @ 10% t.h.d.  
**SCAN RATE:** 5 channels per second  
**SEARCH RATE:** 6 seconds per MHz  
**MEMORIES:** 20  
**FEATURES:** tuning dial as well as keypad, priority channel, mains adapter and mounting bracket available as extras  
**REVIEWED:**  
**PRICE:** £399

## AOR AR-3000

**TYPE:** base station  
**COVERAGE:** 100kHz-2.036GHz  
**MODES:** a.m., n.b.f.m., w.b.f.m., s.s.b., c.w.  
**SENSITIVITY:** 100kHz-2.5MHz s.s.b., c.w. = 1.0µV a.m. = 3.2µV, 2.5MHz-1.86GHz s.s.b., c.w. = 0.25µV, a.m. = 1.0µV, n.b.f.m. = 0.35µV, w.b.f.m. = 3.0µV, 1.8-2GHz s.s.b., c.w. = 0.75µV, a.m. = 3.0µV, n.b.f.m. = 1.25µV, w.b.f.m. = 3.0µV  
**SELECTIVITY:** s.s.b. & c.w. = 2.4kHz/-6dB 4.5kHz/-60dB, a.m. & n.b.f.m. = 12kHz/-6dB, 25kHz/-70dB, w.b.f.m. = 180kHz/-6dB, 550kHz/-50dB  
**RESOLUTION:**  
**IMAGE REJECTION:**  
**IF STAGE:**  
**AUDIO OUTPUT:** 1.4W into 4Ω 10% t.h.d., 0.7W into 8Ω 10% t.h.d.  
**SCAN RATE:** 20 channels per second  
**SEARCH RATE:** 20 steps per second  
**MEMORIES:** 400  
**FEATURES:**  
**REVIEWED:** Short Wave Magazine January 1990 (£1.65 back issue)  
**PRICE:** £765.00

## Uniden Bearcat UBC760XL

**TYPE:** mobile/base station  
**COVERAGE:** 66-88, 108-174, 350-512, 806-956MHz  
**MODES:** a.m., f.m.  
**SENSITIVITY:** 66-88MHz = 0.3µV, 136-174 & 406-512MHz = 0.4µV, 108-136MHz = 0.6µV, 806-956MHz = 0.8µV  
**SELECTIVITY:** -55dB @ ±25kHz  
**RESOLUTION:**  
**IMAGE REJECTION:**  
**IF STAGE:**  
**AUDIO OUTPUT:** 2W @ 10% t.h.d.  
**SCAN RATE:** 15 channels per second  
**SEARCH RATE:**  
**MEMORIES:** 100  
**FEATURES:** backlit controls, options include signal booster pre-amplifier, CTCSS tone squelch decoder  
**REVIEWED:**  
**PRICE:** £235.00



## AOR AR900

**TYPE:** hand-held  
**COVERAGE:** 108-174, 220-380, 406-470MHz, 830-950MHz  
**MODES:** a.m., f.m.  
**SENSITIVITY:** 0.4µV v.h.f. hi & lo, 0.8µV v.h.f. air, 0.5µV u.h.f., 1µV 800MHz  
**SELECTIVITY:**  
**RESOLUTION:** 5, 10, 12.5, 25kHz  
**IMAGE REJECTION:**  
**IF STAGE:**  
**AUDIO OUTPUT:** 120mW @ 10% t.h.d.  
**SCAN RATE:** 15 channels per second  
**SEARCH RATE:**  
**MEMORIES:** 100  
**FEATURES:** supplied with NiCads, mains powered charger, two flexible antennas  
**REVIEWED:**  
**PRICE:** £

## Cobra SR925

**TYPE:** base station  
**COVERAGE:** 29-54MHz, 118-174MHz, 406-512MHz  
**MODES:**  
**SENSITIVITY:** 0.3µV @ 29-54 & 136-174MHz, 0.5µV @ 406-512MHz, 0.7µV @ 118-136MHz  
**SELECTIVITY:** -55dB @ ±25kHz  
**RESOLUTION:** 25kHz  
**IMAGE REJECTION:**  
**IF STAGE:**  
**AUDIO OUTPUT:** 1W into 8Ω at 10% t.h.d.  
**SCAN RATE:**  
**SEARCH RATE:**  
**MEMORIES:** 16  
**FEATURES:**  
**REVIEWED:** Short Wave Magazine April 1990 (£1.65 back issue)  
**PRICE:** £159.95

# ARROW RADIO

LTD

*'The Best Deal in Scanners!'*

## ANTENNA REVIEW

### HOWES AA4

#### ACTIVE SCANNING ANTENNA KIT

With the rapid growth of interest in v.h.f./u.h.f. scanners, there is a corresponding demand for antennas to suit all pockets. Most of this activity has been centred around discones and other passive wideband antennas. The AA4 from C.M. Howes opens up a new avenue that is particularly attractive for those who need an unobtrusive, but effective antenna. The AA4 also has a particular appeal for those who may be restricted to using an indoor antenna. With a frequency coverage of 25 through to 1300MHz the AA4 should suit most of the scanners on the market.

#### Construction

The review model was supplied as a kit, so the first job was to build it! The constructional details were contained on five sheets of A4 that were stapled together. These instructions were well up to the high standard we have come to expect from C.M. Howes. The actual construction was slightly unconventional, but very straightforward. The kit was supplied as a small bag of components and four p.c.b.s. Three of these p.c.b.s were connected together to form the antenna. The fourth board formed the interface unit between the AA4 and the receiver.

The antenna construction was rather unusual so a more detailed description is appropriate. Two of the antenna p.c.b.s were identical and contained a single track throughout their length. This track was broken near one end and drilled to accept a miniature ribbon cable stub. The third of the antenna p.c.b.s contained the final section of the antenna element and the r.f. amplifier.

There were only two areas of the antenna construction that caused any problems. The first

was the ribbon cable stubs, where the insulation was quite difficult to strip. In fact I managed to snap one of the wires and had to piece it out. I would have liked to see some extra ribbon provided to allow for at least one mistake. The other area of difficulty was identifying the correct orientation for the integrated circuit amplifier. The instructions stated that the amplifier should be oriented using a spot on the body as a key. In fact the spot was the smallest of blips on the plastics case next to the type number. Fortunately this turned out to be the correct orientation, but I was a little unsure. I ought to qualify these comments by pointing out that they were really minor shortcomings and I've only mentioned them to help prospective constructors.

The complete construction of the antenna p.c.b.s took about 35 minutes and required only simple tools.

#### Operation

Before operation could begin a few decisions needed to be made regarding an enclosure for the AA4. In its final form it consisted of two units - the active antenna itself and the interface p.c.b. The antenna measured 410mm long and 30mm wide whilst the interface unit was 64 x 31mm. For outside use the best way to mount the antenna was to enclose it within a 37.5mm plastics water pipe. However, if the antenna is to be used indoors only it could simply be hung by a length of cord. One point that needs to be remembered is that height is all important at v.h.f. and u.h.f.

Mounting the interface unit was again very easy using a standard plastics box. As the AA4 was an active unit a power source was necessary. The requirements were a very modest 12 to 14V d.c. at 20mA.

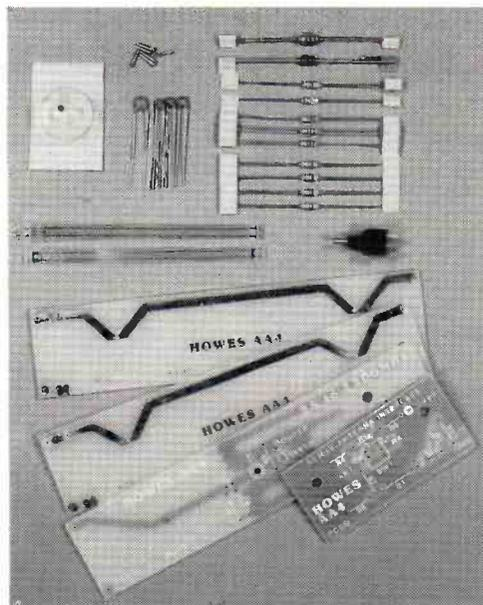

By Mike Richards  
G4WNC

**Active antennas are becoming commonplace on the h.f. bands but are something of a rarity at v.h.f./u.h.f. The C.M. Howes AA4 active antenna kit breaks that trend.**

In fact the current consumption of the review model was just 13.5mA.

#### Performance

With everything finally connected, it was time to see just how the AA4 performed.

Most of the on-air tests were carried out using a Yaesu FRG-9600 that was kindly loaned by SMC Ltd. The initial tests concentrated on the v.h.f./u.h.f. performance and involved comparisons with my discone antenna. I must admit I was very impressed with the results. The received signal strength equaled or bettered the discone throughout the 60MHz to 900MHz range of the FRG-9600.

Signal strength is not the whole story of course and the signal to noise ratio is where active systems tend to fail. However, the AA4 put up a very good show with very little audible degradation of the signal to noise performance. A contributory factor to this success is that the antenna element length is relatively close to the wavelength of the desired signal. This means that the active section of the antenna acts rather like a mast-head pre-amplifier. Incidentally the specified gain of the amplifier was 15dB with a 3dB noise figure.

The instructions mentioned that the antenna could give

useful results at frequencies below 25MHz. This was therefore the next area to be checked out. Comparisons with my long wire antenna revealed that the AA4 was effective down to about 3MHz. Between 25MHz and 3MHz the performance gradually fell away, giving a signal strength about 15dB below that of the long wire at 3MHz. Below 3MHz the drop was quite sharp. This performance was remarkable and certainly expands the potential of the AA4.

#### Conclusion

The AA4 certainly proved itself to be a very capable and versatile antenna. The construction was well within the capabilities of anyone with good soldering skills. The assembled unit was also very compact.

I have no hesitation recommending the AA4 as representing very good value for money.

The AA4 costs £18.80 in kit form or £24.90 as built and tested p.c.b. units. If ordering from **C. M. Howes Communications, Eydon, Daventry, Northants NN11 6PT. Tel: (0327) 61078** you will need to add £1.00 post and packing.

My thanks to **C. M. Howes** for the loan of the review antenna and **SMC Ltd** for the FRG-9600 loan.

**HEAD OFFICE:**

**5 The Street, Hatfield Peverel,  
Chelmsford, Essex CM3 2EJ**

**Tel: (0245) 381626/381673**

**Fax: (0245) 381436**

**Hours: 9-5 (Closed Thursdays)**



YOUR ORDER CAN BE TELEPHONED WITH CREDIT CARD  
DETAILS & DESPATCHED IMMEDIATELY!  
FREE FINANCE ON MANY MAJOR ITEMS AT RRP.  
(Ask for details of qualifying items).

**BRANCHES:**

**GLASGOW:** Unit 17, Six Harmony Row, Govan,  
Glasgow G51 3BA. Tel: 041 445 3060. Hours  
8.30-5.30 Mon-Fri (closed Saturday).

**WIGAN:** Greensway Arcade, Gerrard Street,  
Ashton-in-Makerfield, Wigan, Lancs. Tel: (0942)  
713405. **LEICESTER:** DAVE FOSTER (Agent).  
Tel: (0533) 608189. Latest calls 8.30pm please!

**GUIDE TO UTILITY STATIONS Ninth Edition**

By Joerg Klingenfuss

Published by Klingenfuss Publications

Available from the SWM Book Service December/January

Special Offer Price: £17.00 including p&p. Offer valid on all orders  
placed before 31 December 1990

This is the latest version of the annually updated book. It covers all types of utility stations between v.l.f. and 30MHz. For those of you who want even more up-to-date information, there is a supplement service available which gives you an update in April and August. The range of information included in this book is truly amazing, making the short wave utility listeners 'bible'.

The beginning of the book deals with frequency allocations and covers the entire spectrum from d.c. to 150MHz. As well as the usual tabular representation of the spectrum, extracts from the international radio regulations are published which give the full technical definition of each allocation.

The main frequency list takes up most of the book and lists over 15 000 frequencies between 9kHz and 30MHz. The format used for the display of the data is the frequency followed by the callsign, location including country, mode and any operational notes. As the list also includes voice transmissions the utility stations are highlighted by employing bold type.

A very comprehensive callsign list comes next which is very well presented in that against each callsign is the station name and location followed by all the frequencies used by that call. This is very useful for identifying new stations when all you have is the callsign. Another chapter gives a selection of the regulations regarding the construction and use of callsigns, which is interesting.

Press stations are given a special mention starting with an alphabetical list of countries and their press agencies. This list also gives the transmission times and frequencies of all the stations mentioned. The next list that proves invaluable is the one that comprises a chronological list of press services. In order to find an active press station all you have to do is check against this list for the required time of day and you can instantly see which stations and frequencies are in use.

Then it is the turn of the FAX operator with a list of transmission schedules and frequencies for all the main FAX stations.

The final schedule concerns the NAVTEX navigational and meteorological warning service. Listed here are all the active stations along with their individual times and identification details.

The remaining chapters cover the complete Q, Z and signal reporting codes, along with a host of definitions and regulations. There are even two fold-out maps showing the world and regional air route areas.

**UK LISTENERS CONFIDENTIAL FREQUENCY LIST 7th edition**

compiled by Bill Laver

Published by Spa Publishing Ltd

Available from SWM Book Service

210 x 296mm, 184 pages. Price £8.95 plus 85p p&p

This book provides the reader with a comprehensive list of h.f. frequencies between 2 and 30MHz. It includes details of aviation, marine, broadcast, etc., users along with their location/station and made/callsign/times wherever known.

The main objective is to quickly direct the listener to the frequency, or band of frequencies, most likely to provide the type of stations required. The short wave bands are full of surprises and even the most experienced listener is often rewarded with a new station not heard before -

especially when you know where to start listening.

The entries in the book are placed under block headings. These frequency headings are all based on the international frequency allocations adopted by most countries of the world.

However, not all countries subscribe exactly to these international agreements and there are numerous examples of radio transmissions appearing in unexpected places. So it's best to regard this list as a starting point from which to build-up your own bigger and more specialised listings.

# SCAN THESE

**SCANNERS 2 International VHF/UHF Communications Guide**

Peter Rouse GU1DKD

Published by Argos Books

Available from the SWM Book Service

152 x 233mm, 261 pages. Price £9.95 plus 85p p&p

This book is a companion to *Scanners*. It provides even more information on the use of v.h.f. and u.h.f. communication bands and gives details on how to construct accessories to improve the performance of scanning equipment.

The book is international in scope and contains frequency allocations for all three ITU Regions, including country by country variations. Also included

are international callsign series, marine allocations, spot frequencies of major world airports, repeaters and beacons. The technical section covers construction of broadband antennas and signal boosters, power supplies, chargers and even a complete 10-channel scanner! Hints are provided on servicing, modifications and useful solid-state devices for experimental circuits.

**MARINE UK RADIO FREQUENCY GUIDE**

compiled by Bill Laver

Published by Spa Publishing

Available from SWM Book Service

210 x 296mm, 62 pages £4.95 plus 85p p&p

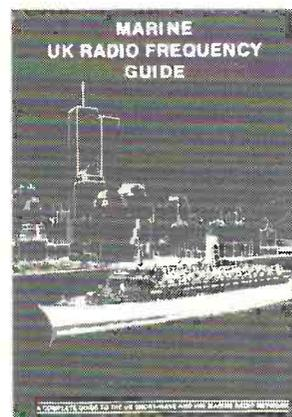

The latest in a range of frequency guides compiled by Bill Laver, this one covers all the UK short wave and v.h.f. marine radio networks.

The book starts with a series of explanatory chapters dealing with the marine band, digital communications, FAX, main l.f./h.f. calling frequencies, long-distance communications, Portishead Sector Watch, the v.h.f. band, radio aids and weather broadcasts. The rest of the book is devoted to a listing of port stations giving locations frequencies and channel number, a list of the world marine coastal phone stations and the international marine short wave allocations. A useful reference book for those listeners into the maritime radio scene.

**SCANNERS A VHF/UHF Listener's Guide 3rd Edition**

Peter Rouse GU1DKD

Published by Argos Books

Available from the SWM Book Service

152 x 233mm, 245 pages. Price £8.95 plus 85p p&p

This is a good guide to the use of scanning receivers and the principles behind their operation. First published in 1986, *Scanners* has gone through several revisions and this 3rd edition is heavily up-dated.

The book covers just about every aspect of scanning and the contents form an invaluable guide for the newcomer to the hobby, with many of the more complicated aspects of radio communications explained in concise and easy-to-understand terms.

*Scanners* covers equipment, accessories and antennas, and explains basic radio theory, modes and simplex and duplex transmissions. It shows you how to install and use base stations, mobile and portable equipment.

# SCANNING THE MARINE BANDS

BY Peter Rouse  
GU1DKD

**This is how mariners chat amongst themselves and with the shore stations and how they even connect to the public telephone network.**

The marine v.h.f. f.m. band has several interesting features and is unique in the way that it used. Being close to the amateur 144MHz band, it shares the same characteristics and it is interesting that many manufacturers of 144MHz band equipment offer virtually identical sets for marine use. Ranges of 80km or more across water are quite common and when 'lifts' are on (tropospheric ducting in particular) it is often possible to hear stations hundreds of miles away.

The band lies between 156 and 162MHz and is used in a variety of ways, either with straight single channel working or split frequency operation. The latter is what makes full-duplex connection to the public telephone network possible.

The band is channelised with numbers between 1 and 88 and two marina operation channels known as channels 'M' and 'M2'. Stations on the band will always refer to the channel numbers and you will never hear mention of the actual frequency which is why it is important to have a list such as the one provided. Channel '0' is strictly reserved for the lifeboats and coastguard.

It is common practice for a station, either a ship or shore station, to make their first contact on Channel 16. Having established contact the two stations will then move to what is known as a 'working channel'. This used to be a strict rule at one time but ships do now have a tendency to call shore stations direct on their known working channel. This practice does have the advantage of leaving Channel 16 clear because this is also the main distress channel. Once an emergency has been declared no ship, other than those involved in

rescue work, may call on the channel until the station co-ordinating the rescue has declared that the emergency is over.

All ships radios must have Channel 16 fitted and many modern transceivers have what is known as dual watch. This is a simple scanning device which allows the operator to monitor both Channel 16 and one other channel. Maximum power output is 25W and in addition to marine mobile units many ships and port personnel now carry hand-held transceivers.

## Allocations

Each channel is allocated for a specific use or uses. Channels such as 6, 8 and 10 are used for ship-to-ship working and in most areas it is quite common to hear fishermen chatting to each other on these channels.

Port operations channels are used for vessels contacting ports and typical messages concern arrival and departure times, berthing arrangements, etc.

Link call channels are for vessels wanting to connect to the public telephone service through a suitably equipped shore station. Skippers normally use their vessel's name as a callsign however when link calls are made you will hear them quote their official callsign. For instance my own boat is called *Snapper* and when in contact with another vessel or the local harbour office that is the callsign used. However, for link calls I have to use my officially registered callsign which is "Mike Juliet Sierra X-ray Five" (MJSX5) so that the charge for the call can be properly billed to my account.

## Jargon

Marine band operators generally use plain speech and the phonetic alphabet where needed and all times are referred to in UTC. There are one or two expressions though that are worth noting:

- Mayday** Repeated three times this is the international distress call.
- Pan-Pan** An urgent call for help where no one is in immediate danger.
- Securite** Pronounced 'securitay' this word precedes any message that contains a reference to safety (gale warnings, navigation hazards, etc).
- Zulu** Any time suffixed with 'Zulu' indicates it is UTC
- Alpha** Any time suffixed with 'Alpha' indicates it is BST
- UTC** Universal Co-ordinated Time is what was formerly known as Greenwich Mean Time or GMT.

## Marine Channels v.h.f./f.m.

Channel	Ship TX	Shore TX	Allocation
0	156.000		Coastguard/Lifeboat
1	156.050	160.650	Port Operation /Link Calls
2	156.100	160.700	Port Operations/Link Calls
3	156.150	160.750	Port Operations/Link Calls
4	156.200	160.800	Port Operations/Link Calls
5	156.250	160.850	Port Operations/Link Calls
6	156.300		Intership
7	156.350	160.950	Port Operations/Link Calls
8	156.400		Intership
9	156.450		Intership
10	156.500		Intership
11	156.550		Port Operations
12	156.600		Port Operations
13	156.650		Port Operations
14	156.700		Port Operations
15	156.750		Port Operations
16	156.800		*** Distress and Calling ***
17	156.850		Port Operations
18	156.900	161.500	Port Operations
19	156.950	161.550	Port Operations
20	157.000	161.600	Port Operations
21	157.050	161.650	Port Operations
22	157.100	161.700	Port Operations
23	157.150	161.750	Link Calls
24	157.200	161.800	Link Calls
25	157.250	161.850	Link Calls
26	157.300	161.900	Link Calls
27	157.350	161.950	Link Calls
28	157.400	162.000	Link Calls
60	156.025	160.625	Link Calls
61	156.075	160.675	Link Calls
62	156.125	160.725	Link Calls
63	156.175	160.775	Link Calls
64	156.225	160.825	Link Calls
65	156.275	160.875	Link Calls
66	156.325	160.925	Link Calls
67	156.375		Intership/Small yacht safety/ Coastguard
68	156.425		Intership
69	156.475		Intership
70	156.525		Digital Selective Calling/ Distress
71	156.575		Port Operations
72	156.625		Intership
73	156.675		Intership
74	156.725		Ports/lock keepers/swing bridges
77	156.875		Intership
78	156.925	161.525	Port Operations
79	156.975	161.575	Port Operations
80	157.025	161.625	Port Operations
81	157.075	161.675	Port Operations
82	157.125	161.725	Port Operations
83	157.175	161.775	Port Operations
84	157.225	161.825	Port Operations
85	157.275	161.875	Port Operations
86	157.325	161.925	Link Calls
87	157.375	161.975	Link Calls
88	157.425	162.025	Link Calls
M	157.850		Marinas
M2	161.675		Marinas & Yacht Clubs

### Related frequencies used for emergencies, search and rescue (SAR), etc.

All are a.m.

Civilian Air Emergency	121.500	
Boulmer Rescue		123.100 - 285.850 - 233.700 - 282.800
Leconfield Rescue		122.100 - 369.650 - 282.800
NATO (scene of search)	282.800	
Search and rescue aircraft		123.100
Lighthouse helipads	129.700	
Fisheries protection aircraft		122.100 (North sea) 131.800 (Eng Channel & approaches)

### On-board-ship u.h.f. handset frequencies

Ch. 1	457.525	Ch. 1A	467.525
Ch. 2	457.550	Ch. 2B	467.550
Ch. 3	457.575	Ch. 3B	467.675



**Some changes are being considered to parts of the v.h.f. and u.h.f. spectrum to try and reduce problems of interference from continental stations and to make more room available for new services such as the pan-European paging service (ERMES). The latter will wipe out half the channels available for short term hire.**

BY Peter Rouse  
GU1DKD

## UHF Cross Channel Interference

The biggest dilemma facing the UK authorities at the moment is the interference being caused to p.m.r. and emergency service u.h.f. channels by stations in Western Europe where the split frequencies for bases and mobiles work in reverse to the UK plan in the range 420 to 470MHz. To fully understand why this problem arises we need to look at why there is an advantage in using split frequencies.

Let us assume a bases station is working on 450MHz and receiving the signals from its mobiles and hand portables on 455MHz. The transmitting and receiving antennas will be sited in the best possible position for maximum coverage and may well be on a tower on a hill top. In contrast the aerials on the mobiles and hand sets will be in far from ideal situations. For instance, they may be in built up areas of towns and cities. As such their transmissions will not travel far and indeed the power of their transmitters will be considerably less than that of the base station. They will also only be able to receive signals from their own base station. All this means that the same set of frequencies can be allocated to another user not too far away because there is little chance that the two users will interfere with each other. However, if you swap the frequencies around then you will have a well sited transmitter operating on the same frequency as the well sited receive antenna of another base station and the result can be that the latter station then cannot hear the weaker transmissions from its own portables and mobiles.

The problem now is that the segments of the spectrum allocated for mobile and handset transmission in the UK are allocated for bases station transmission in such countries as France, Holland, Belgium and Germany. The problem can be quite severe during lifts. It has been compounded by new continental services such as Radiocom 2000 in France.

The DTI admit that this is an extremely complicated problem and one that is not going to be easy to solve but it is still not

clear just what they intend to do about it. They say they are 'actively pursuing the problem with the French and other administrations to see if the problem can be reduced'.

The Mobile Radio Users Association say the only long term solution is to rearrange the the u.h.f. allocations to match the continentals. The DTI say that would be 'an enormously complicated and expensive exercise for all concerned'. It's not clear though why the DTI appear reluctant to accept this as the inevitable course particularly as the MRUA are the ones who will largely foot the bill and have suggested it.

## Pan-European Paging (ERMES)

More changes are afoot and again because of our continental friends. A pan-European paging service (ERMES) is scheduled to come on line in 1992. The band will be 169.400 to 169.800MHz and power will be 100W e.r.p. per transmitter. That sub-band falls inconveniently inside p.m.r. single channel simplex High-band (including 6 short term hire channels) and so anyone in that segment is going to have to move and that may bring some interesting situations for users who have an allocation in the London area. That's because no new high band allocations are going to be made within the area bounded by Europe's largest car park - the M25. High band users in the that area are already having to share channels and the communications on some frequencies is already chaotic. Low band is not much better so perhaps they may care to try Band III and log onto one of the trunking systems (now up to 9 regional and 2 national services).

## CTCSS and Selcall

One of the problems of two or more users sharing a channel is operators having to listen to messages that are intended for other users. The way round this is to use selective calling or CTCSS (continuous tone controlled signalling system or 'Cuts' as some engineers call it) and the DTI intend to make it compulsory in the near future for all new operators to CTCSS

fitted.

CTCSS is already used for shared services and community repeater systems. In the latter case it's to ensure that the repeater is only activated by stations who are part of the repeater net and that the repeater does not respond to other signals during lift conditions. In practice a continuous sub-audible tone is sent every time the transmitter is keyed. The corresponding receiver is programmed to only open the squelch when it receives that tone. A fairly wide range of tones are available which means that even on a shared channel mobiles can have their own tone and so the receiver only activates when it's own base station is calling it. Selective calling or Selcal achieves the same thing but by using a short burst of audible tones at the start of each transmission. In the case of Selcal a pair of tones are used and by using various combinations it's possible to get hundreds of permutations of codes.

It's interesting to note that in the USA some amateur repeaters can now only be accessed by transmitting the appropriate CTCSS. Most modern v.h.f. amateur and commercial transceivers can now be fitted with boards that can be programmed with any of the CTCSS tones and in the case of some transceivers the tone can even be selected by the user on the set's keypad and programmed into memory along with the transmit and receive frequencies.

## Short Term Hire (STH)

A number of changes are in store for the channels allocated for short term hire. Six channels will be lost because of ERMES (see above) but so far no replacement allocations have been announced. New allocations are going to be offered but the DTI say this will only be if licencees stick to the new Code of Practice. They say the regulations governing the use of these channels has been subject to considerable abuse in the past. They have not been specific but its understood that

users have been operating on these channels without the proper authorisation and beyond the periods specified in their licences. The 28 day licence is going to be dropped and in future only 1 year licences will be issued.

For anyone not familiar with STH let me briefly outline the details. Say you are organising a special event or you are a builder working on a contract that requires portable two-way communication. You can hire equipment from one of several firms and they'll programme it to operate on one of the available frequencies. That means you do not have to apply for your own frequency - something that can take rather a long time - but you have to accept that you may end up sharing the channel with others. The STH channels available are:

72.3750MHz (base) -  
85.8750MHz (mobile) split frequency simplex.  
140.97875MHz single frequency simplex.  
169.0125, 169.1375,  
169.1875MHz all single frequency simplex.  
169.4375, 169.4875,  
169.5375, 169.5750, 169.6375,  
169.7625MHz all single frequency simplex and due to be phased out to make way for ERMES.  
456.9250MHz (base) -  
462.4750MHz (mobile) split frequency simplex.

## Outside Broadcasts

There are reliable reports that television broadcasters are using channels in the range 224 to 225MHz for outside broadcast links. This is part of the old Band III television allocation and there appears to be a definite pairing between channels in this band and those allocated to broadcasters in the 141.200 to 141.900MHz band with the latter being used for wideband f.m. feeds to studio control rooms and the former for talkback. Pairings so far spotted are 224.08125/141.24375 and 224.16875/141.25675. Its also understood that the 224MHz band is being used by handhelds and that four digit selcalls are in use on lower band.

Now available

the **NEW** 1990 catalogue from NEVADA

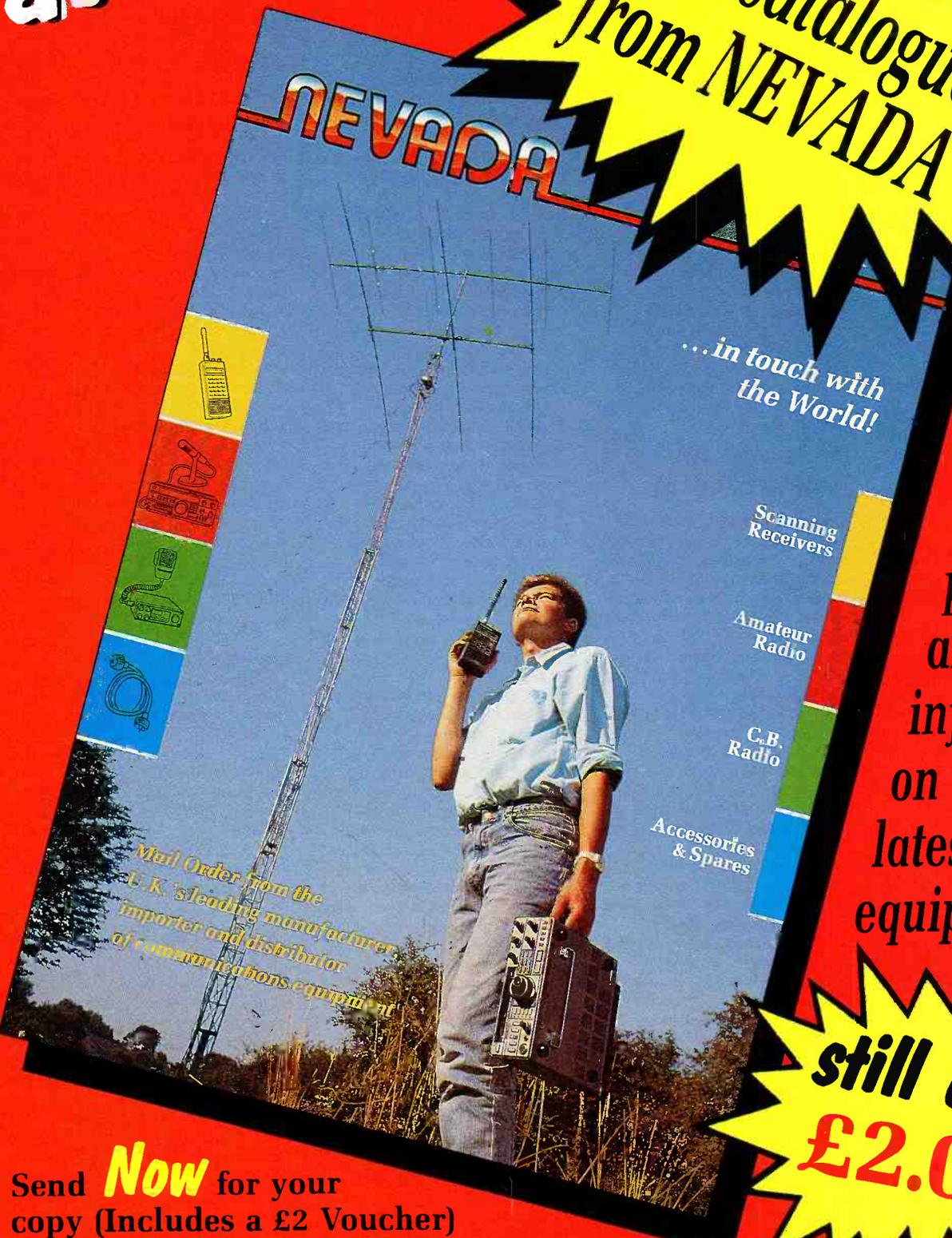

NEVADA

...in touch with the World!



Scanning Receivers

Amateur Radio

C.B. Radio

Accessories & Spares

Packed

full of products and information

on all the latest equipment...

Mail Order from the U.K.'s leading manufacturer, importer and distributor of communications equipment

still only £2.00

Send **Now** for your copy (Includes a £2 Voucher) Or Call using your Credit Card on our **HOTLINE (0705) 662145**

The UK'S Leading Distributor with Approved Dealers throughout the UK 189 LONDON ROAD NORTH END PORTSMOUTH PO2 9AE

**NEVADA** COMMUNICATIONS

# CODE 3 DATA DECODING SOFTWARE

both 300 baud h.f. signals and the 1200 baud signals found on v.h.f. One particularly useful feature of this module was that you could choose to monitor data for a particular station only. This overcomes one of the major problems for the packet listener. You usually have to pick out the required data from amongst a whole range of other signals. This simple system completely solves that problem.

The FAX implementation was also worthy of discussion as it was very much a mixture of good and bad. Although this module works with all the common computer screen types, by far the best results are obtained with a VGA system. When designing a FAX reception system there are two display options to choose between - screen or printer. The screen option has the advantage of easy image manipulation and a saving of paper. The printer option is capable of higher resolution and is great for weather charts. The system chosen for the Code 3 was screen oriented so it was no surprise to find that the printer output was disappointing. The compensation was in the excellent reproduction of press photos on a VGA screen. One other point about this module was that the initial configuration of r.p.m., IOC, etc. was rather tedious. This was because you could only alter one parameter at a time and the program put you back into receive mode between each change.

The Morse decoding mode was very well implemented and included a useful automatic speed function. This could track the speed of the incoming signal to ease decoding and indicated of the current speed on the screen. The operator also had the option to adjust the speed if necessary. Another good point was that the centre frequency of the decoder was changed to the standard 800Hz allowing standard narrow c.w. filters to be used for improved performance.

The remaining modules were well organised and contained all the facilities required for effective monitoring.

## Signal Analysis

Signal analysis is one area where the Code 3 stands out from the crowd as a very competent program.

As with any sophisticated tool you do require a sound understanding of data transmission techniques to utilise these features.

The Speed Shift facility that I mentioned earlier is the starting point for all analysis. This is because the basic parameters established with this module are carried through into the others. So let's run through the analysis modules giving a brief outline of their capabilities on the way.

**Autocorrelation - Bit.** This enabled

Mode Table	
AX-25 Packet	300 & 1200 baud.
Hell	Sync & Async 122.5, 250 & 300 baud.
FAX	60, 90, 120, 180 & 240 r.p.m., APT, IOC 176, 288, 352 & 576.
Morse	Auto & manual speed.
Twinplex	F7b, b2 to F7b6 CCIR 476.
DPA Press	F7b 300 baud ASCII.
VWD Business	F7b 300 baud ASCII.
SID Sport	F7b 300 baud ASCII.
ASCII	ITA5 50-300 Baud.
Baudot	ITA2 45-300 Baud.
Autospec Bauer	ITA2/5 bit 62.3, 68.5 & 107.75 baud + interleaving Spread 21, 51.
Duplex ARTRAC	ITA2 125 baud.
ARQ	CCIR476, CCIR625 mode A 100 baud.
ARQ-E	ARQ1000 96 baud.
ARQ-N	ITA2 Duplex.
ARQ-F	Special ARQ mode.
ARQ-E3	CCIR 519 variant 72, 96, 100 baud.
ARQ-S	ITA3/7 bit ARQ 1000S 96 baud.
ARQ-SWE	CCIR618 variant 100 baud.
FEC	CCIR 476 CCIR625 mode B.
FEC-A	ITA2-P, FEC 100 96 & 144 baud.
FEC-S	ITA3, FEC 1000S 96 baud.
TDM-342	ITA2, CCIR342, 96, 200 baud 2 chan, 192 baud 4 chan.
TDM-242	ITA3, CCIR242, 96 baud 2 chan, 192 baud 4 chan.

the repetition cycle of the transmission to be measured. An example of a repetition cycle being a single burst of a SITOR signal. If this was 100 baud the repetition cycle would be 45 bits.

**Correlation - Mod.** This takes the digitally filtered data stream and gives accurate baud rate information and uses Fourier Transform. It also can be used to check if a signal is synchronous or asynchronous.

**Speed - mark/space.** This was a very

interesting module that enabled the operator to check for the presence of part elements in the signal. An example of part elements being the 1.5 stops bit that are often found in RTTY signals.

**Character Analysis - Simplex.** This was a very powerful module that displayed seven lines at the top of the screen. These line contained all the combinations of the seven bits of each character. The operator could then choose any one of these to be printed in

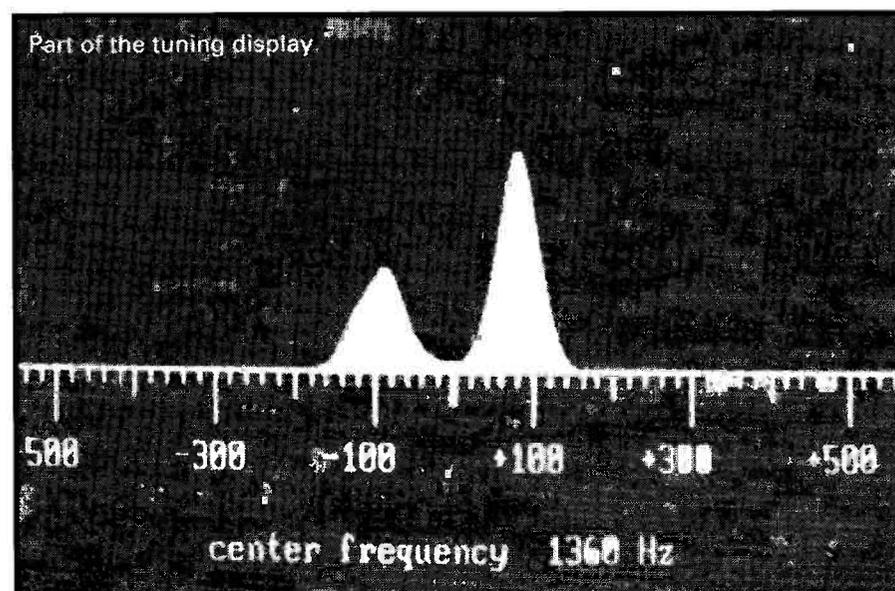

# CODE 3 DATA DECODING SOFTWARE

the bottom part of the screen. There was also the option to select from several standard alphabets. As you can see this was a great tool if you know what you are looking for.

**Character Analysis - Duplex.** This was very similar to the simplex mode except that there were two sets of seven lines displayed. This was to allow for multi-channel working.

As far as I'm aware there is no other package available that gives anything like this range of signal analysis. When you consider that you can use all the analysis modules with data stored in the buffer the potential is enormous.

## Decoding Technique

I thought it would be interesting to give a brief explanation of the data capture system as it is slightly unusual. Most decoders take the incoming audio signal and convert the two tones into two digital levels. This digital signal is then passed to the serial port of the computer. The system used in the Code 3 is totally different.

The decoder monitors the incoming audio signal for zero crossings or transitions and then measures the time between these events. The timer comprises a counter that runs from 0 to 255, at each transition the count is latched to the serial port and the counter reset. So the output from the decoder is a series of numbers between 0 and 255 representing transitions of the signal. It is this stream of data that is stored in the internal buffer. Incidentally the data rate between the decoder and the computer was 19.2Kb/s to ensure that the data could keep ahead of the audio signal.

## Summary

There can be no doubt that the Code 3 is an exceptional decoding program. It was written by a professional and its decoding powers are excellent. The problem is that it falls down on presentation and usability. The manual really needs



completely rewriting and there are several minor, but irritating, operational bugs. If it could be tidied up and made user friendly it would be head and shoulders above anything else on the market.

I know that the program is in regular use in at least one professional monitoring station and this in itself is testimony to the program's capabilities. I have also discovered that the program has undergone several updates to remove many of the bugs. Incidentally the review copy was version 3.6.

So to conclude, I have no hesitation in recommending this package to any experienced operator. The newcomer, however, will have difficulty getting the best out of the program especially in view of the poor manual.

The program is available from **Hoka Electronic, Feiko Clockstraat 31, 9665 BB Oude Pekela, The Netherlands. Tel: (31) 5978-12327 FAX (31) 5978-12645**, who I would like to thank for the loan of the review package. □

Abbreviations	
APT	automatic picture transmission
ASCII	American Standard Code for Information Interchange
CGA	Colour Graphics Adapter
EGA	Enhanced Graphics Adapter
FAX	facsimile
f.s.k.	frequency shift keying
Hz	hertz
IOC	Index of Co-operation
Kb/s	kilobites per second
k.f.	low frequency
mm	millimetre
RAM	Random Access Memory
r.m.s.	root mean square
r.p.m.	revolutions per minute
RTTY	Radio Teletype
SITOR	Simplex Teleprinter
t.d.m.	time division multiplex
V	volt
VGA	Versatile Graphic Array

THE UP-TO-DATE NEWS & INFORMATION SERVICE FOR  
THE LISTENING ENTHUSIAST

**RADIO LINE**

**0898 654676**  
UPDATED EVERY SATURDAY

**RADIO LINE**

Calls charged at 33p per minute cheap rate,  
44p per minute at all other times.

## NEW WX 1700 METEOSAT WEATHER SATELLITE SYSTEM FOR IBM AND IBM COMPATIBLES

### WX-1700 System consists of:

- ★ Outdoor unit with a complete weather-proof Meteosat Receiver
- ★ Indoor unit, containing the power supply and necessary remote controls
- ★ Interface card for an IBM or IBM compatible computer
- ★ Software to produce high definition images on your PC (EGA or VGA)

NOTE: All you need in addition to this is a Dish Antenna and your PC!

Demonstration Disk available on 5.25" Disk. Please send £5.00 + £1.50 P&P.

### FEATURES

- ★ You can receive both Meteosat Channels!
- ★ Will operate on any IBM (or compatible) MS-DOS Personal Computer (XTor AT)
- ★ EGA or VGA colour images (automatic selection)
- ★ Extremely high definition: 800 x 600 pixels with VGA  
640 x 350 pixels with EGA
- ★ Colours: 256 colours out of a palette of 250000 colours in VGA (512k) 64 colours with EGA
- ★ Will decode ALL polar orbiting and geostationary weather satellite signals
- ★ Will also decode h.f. facsimile stations (f.m to a.m. converter needed)
- ★ Can store at maximum of over 200 lines per picture
- ★ Animation of up to 99 stored pictures!
- ★ Various separate animation sequences possible
- ★ Picture Save and Load
- ★ Zoom In and Out
- ★ Picture shift in two directions (centering) etc.
- ★ Temperature indication of predetermined places and/or any desired place on infra-red images!
- ★ Moisture distribution shown on WV (Water Vapour) images
- ★ Automatic colouring of Europe (on D2 chart)
- ★ City names indicated on screen (maximum of 40 programmable with co-ordinates)

**THE BEST FEATURE IS THE PRICE!!! ONLY £575.00 inc VAT Carriage £7.00**

Note: We can also supply Dish antennas complete. Prices are as follows:

85cm Dish - £199.00 inc. VAT  
100cm Dish - £225.00 inc. VAT Carriage on Dishes = £15.00

#### HF-225

HF General Coverage Receiver, 30kHz to 30MHz.  
(The HF-225 has been voted "Receiver of the Year" by World Radio and TV Handbook).

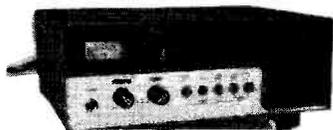

ONLY £425.00 + P&P £7.50

#### R-5000

This is the top of the range HF Communications Receiver from Kenwood and is our best selling model! This superb receiver covers from 100kHz to 30MHz and with the optional VC-20 converter will also cover from 108MHz to 174MHz.



ONLY £875.00 + P&P £10.00

#### IC-R72

This New HF receiver from Icom is a real winner! Covering 100kHz to 30MHz in s.s.b., a.m. and c.w. modes with an optional UI-8 for f.m. reception. The IC-R72 has a unique internal storage battery which provides approx. one hour of operation when an external supply is not available!!



ONLY £645.00 + P&P £7.50

**NEW - AR-3000 - NEW YES IT'S FINALLY HERE!!**  
The AR-3000 Wideband Receiver is now available.



#### Basic Spec.

Freq. range: 100kHz to 2036MHz without any gaps.  
Reception Modes: LSB, USB, CW, FM (wide), FM (narrow) and AM.

Mem. channels: 400 memory channels in 4 banks of 100.  
Freq. selection: By direct keypad entry or by tuning knob on front panel.

ONLY £765.00 + P&P £7.50

#### AR-1000 HANDHELD SCANNER



#### Basic Spec.

Freq. ranges: 8-600MHz and 805-1300MHz  
Freq. selection: By direct keypad entry or by tuning knob on top panel.  
Mem. channels: 1000 arranged conveniently in ten banks of 100, with direct keyboard access to any memory.  
Reception Modes: AM, FM (narrow) and FM (wide).

RECEIVER COMES COMPLETE AND READY TO GO  
ONLY £249.00 + P&P £4.50

#### ACCESSORIES

(P&P)  
D130N Wideband Discone covering 25-1300MHz, complete with 15 metres of low loss cable. ....£82.50 (£5.00)  
Royal 1300 Wideband Discone covering 25-1300MHz. ....£59.95 (£5.00)  
DSH Active Antenna, covers 100kHz to 50MHz .....£49.99 (£5.00)  
Confidential Frequency List (7th Edition) .....£7.95 (£1.50)  
Complete VHF/UHF Frequency Guide. ....£5.95 (£1.50)  
Short Wave listeners Book .£3.49 (£1.00)  
Mono Headphones for use with Scanners etc. ....£5.95 (£2.00)  
Telescopic Antenna covers 25-1300MHz for use with Scanners. ....£6.99 (1.50)

**AUTHORISED AGENTS FOR KENWOOD, ICOM, STANDARD & YAESU. FULL SERVICE FACILITIES AVAILABLE**

SPEND UP TO £1,200 INSTANTLY WITH A PHOTO ACOUSTICS LTD. CREDITCHARGE CARD - APPLY FOR DETAILS  
PART EXCHANGE WELCOME. ASK FOR KERRY G6IZF OR ANDY G4YOW  
RETAIL SHOWROOM OPEN MONDAY-FRIDAY 9.30-5.30, SATURDAY 9.30-4.30



Goods normally despatched within 24 hours. Please allow 7 banking days for cheque clearance. Prices correct at time of going to press. E&OE

# DEWSBURY



# ELECTRONICS



FRG 8800 £649

IF IT'S  
KENWOOD  
IT MUST BE  
DEWSBURY

A FULL RANGE ALWAYS IN STOCK



KENWOOD R5000 £875



KENWOOD R2000 £595



NRD 525 £1095



IC — R71E £855

**DEWSBURY ELECTRONICS ARE ABLE TO OFFER THE SHORT WAVE LISTENER A FULL RANGE OF RECEIVERS, RTTY, TOR, FAX, ASCII, DECODERS, PRINTERS AND MONITORS.**

**AERIALS ARE AVAILABLE FOR ANY SIZE OF INSTALLATION**

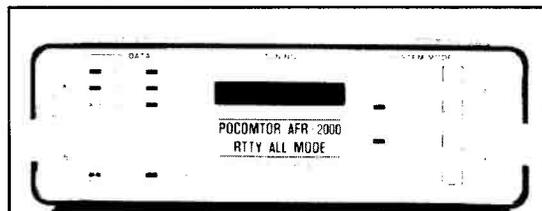

**POCOM AFR2000/2010  
RTTY ALL MODE DECODER  
PRICES FROM £499  
POCOM RTTY/ALL -mode decoders  
AFR 2000 - 2010  
SAE FOR DETAILS**

**A STAMPED ADDRESSED ENVELOPE WILL BRING YOU DETAILS OF ANY OF THESE PRODUCTS.**

Stockists of DAIWA — MET ANTENNAS — POCOM — ICOM — YAESU — MICROWAVE MODULES  
JRC — BNOS — WAVECOM

**Dewsbury Electronics, 176 Lower High Street, Stourbridge, West Midlands DY8 1TG**

**Telephone: Stourbridge (0384) 390063/371228**

**Fax: (0384) 371228**



Instant finance available subject to status. Written details on request

# GIFT SUBSCRIPTIONS TO SWM



## Only a few more shopping days left before Christmas.....

Are you having trouble choosing a suitable present for a loved one, or perhaps you are the one no-one can think of an appropriate gift for?

### We have the answer - a Gift Subscription to Short Wave Magazine

For just £19 we will send the recipient a Christmas card telling them about their gift and a free copy of Wires & Waves - A Practical Antenna Guide.

A one year subscription to Short Wave Magazine also entitles the recipient to free membership of the Subscribers Club, which will give them special offers and free-to-enter prize competitions every month.

Fill in the form below and send it to Short Wave Magazine Christmas Subscription Offer, FREEPOST, PW Publishing Ltd., Enefco House, The Quay, Poole, Dorset BH15 1PP. Payment can be made by cheque or credit card. All orders received before December 14 will be despatched by Monday December 17.

Please indicate the type of subscription required:

**SHORT WAVE MAGAZINE 1 YEAR**

- £19.00 (UK)
- £21.00 (Europe)
- £22.00 (Rest of World)

Prices current at October 1990.  
Subscription to commence with issue dated January 1991.

**Recipient's Name** .....

Address.....

.....

**To: Short Wave Magazine Christmas Subscription Offer, FREEPOST, PW Publishing Ltd, Enefco House, The Quay, Poole, Dorset BH15 1PP**

Your Name.....

Address.....

.....

I enclose cheque/PO (Payable to PW Publishing Ltd) £.....

Charge to my Access/Visa Card the amount of £.....

Card No.

Valid from ..... to .....

Signature.....



Credit Card Orders can be taken on (0202) 665524.

# STARTING OUT

Brian Oddy

Perhaps the simplest method of installing a resonant half-wave antenna for the lower frequency s.w. broadcast (or amateur) bands is to erect it in the form of an inverted 'L'. This way, one end of the wire can then be brought directly into the building and connected to the high impedance antenna terminal on the receiver - see **Fig. 1a**. In the case of a portable set, the end of the antenna may be clipped onto the tip of the telescopic whip when it is fully extended.

The overall length of wire required for a favourite band can be calculated by using the formula quoted last month, which takes into account end effect:

$$L = 142.5/f$$

where L is the length in metres and f is the frequency in MHz.

Since the s.w. broadcast (or amateur) bands are relatively narrow, taking the centre frequency of the band concerned will ensure an acceptable performance.

Ideally the antenna should be constructed from a length of 18 or 16s w.g. cadmium copper wire, because soft drawn copper wire is liable to stretch. Enamelled wire will offer some resistance to the corrosive atmosphere found in large towns and near the sea. Although stranded copper wire can be used, care must be taken to ensure that each strand makes good contact with the receiver antenna terminal and that there are no broken strands along the length. Plastics covered, flexible wire is best avoided as it is very liable to stretch.

To avoid changes in the characteristics of the antenna in wet weather, glass or ceramic strain insulators that have a long leakage path, should be employed at the points of suspension. Nylon rope is fairly resistant to the effects of the weather and is suitable for the halyards used to raise the antenna. A lead-through insulator will be required where the wire enters the building. Once inside, the wire must be kept well clear of all objects on its way to the receiver. Otherwise the tiny signals will be quickly lost through leakage due to either poor insulation, or

**The nature of radio waves and the basic principles of a resonant half-wave or Hertzian antenna were outlined last month. A practical method of erecting a half-wave antenna is described.**

capacitive coupling to earth. Some means of disconnecting the antenna from the lead-through insulator should be provided outside the building, so that it can be connected directly to earth when not in use. This ensures that static charges cannot build up on the wire.

Before making off the remote end of the wire to the insulator, clean the end for a distance of about 150mm with glass paper. Pass the wire through the hole in the insulator and form a loop by wrapping the end around the cleaned portion of the main wire a few times - see **Fig. 1b**. It is advisable to solder the wire wrap, as any intermittency at this point will alter the effective length of the wire. The overall length of the wire should be measured from the point where the loop passes through the insulator to the antenna terminal on the receiver.

## Multi-band Operation

So far, only single band operation has been mentioned. It is possible to use a half-wave inverted L antenna at frequencies which are harmonically related to the fundamental to which it is cut. Harmonics are odd and even multiples of the fundamental frequency e.g. the second harmonic is twice the fundamental, the third harmonic is three times the fundamental, etc. Note that there is no first harmonic, because one times the fundamental is still the fundamental!

When a half-wave antenna is operated at twice the fundamental frequency it

will contain two half-waves (i.e. a full-wave). The distribution of voltage and current along the wire will be as shown in **Fig. 2a**. Because the signal currents in the two half-waves are out of phase, their associated fields interact to produce a directivity pattern which resembles a clover-leaf. The maximum response to incoming signals is in four lobes at 54° to the line of the wire - see **Fig. 2b**. The minimum pick-up is at right angles to the wire, also off the ends.

The distribution of voltage and current along a half-wave antenna that is operated at three times the fundamental frequency to which it is cut, is shown in **Fig. 3a**. The maximum response to incoming signals is in six directions, with four lobes at 45° plus two at 90° to the wire - see **Fig. 3b**. Note that there are deep nulls, or areas, of minimum response between the lobes.

When an antenna is several wavelengths long at the operating frequency, it is usually referred to as a long wire. In contrast, a random wire antenna consists of a length of wire which is not resonant at the frequency in use. In practice, a half-wave antenna will not be truly resonant when operated at multiples of the fundamental frequency.

This is because the formula used to calculate the length of wire required for resonance at the fundamental includes a correction factor for end effect. As explained last month, this results in a 5% reduction in the overall length. To ensure that the wire will be resonant when it contains several half-waves, the correction for end effect must only be applied to the end quarter-waves. A modified formula must therefore be used when calculating the length, which takes into account the number of half-waves involved:

$$L = 150(N-0.05)/f$$

where L = length of wire in metres; N = number of half-waves; f = frequency of operation in MHz.

The following example shows the difference in the length required when a half-wave antenna, resonant at 7.200MHz, is operated at three times the fundamental frequency, namely 21.600MHz.

The length of wire required for resonance at the fundamental may be calculated by using the standard formula  $L = 142.5/f$

$$\text{thus } L = 142.5/7.2 = 19.791\text{m.}$$

The formula  $L = 150(N-0.05)/f$  is used to calculate the length of wire required for resonance at three times the fundamental frequency:

$$\text{thus } L = 150(3-0.05)/f = 150(2.95)/21.600 = 20.486\text{m}$$

The 7.200MHz antenna will therefore be too short for resonance at 21.600MHz by an amount equal to  $20.486\text{m} - 19.791\text{m} = 0.695\text{m}$ . Although the difference may

Fig. 1a.

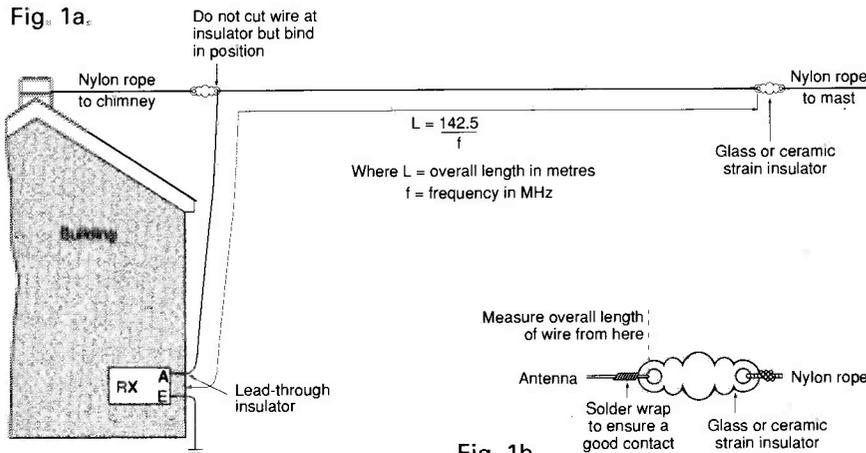

Fig. 1b.



# STARTING OUT

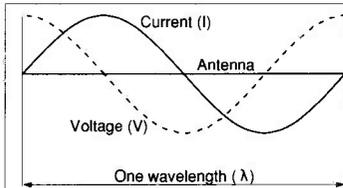

Fig. 2a.

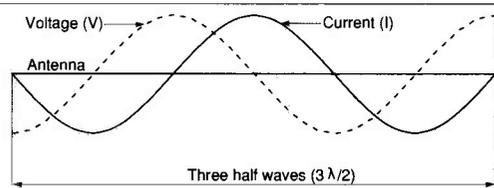

Fig. 3a.

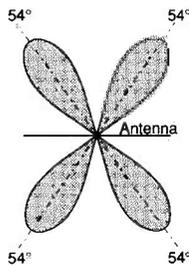

Fig. 2b.

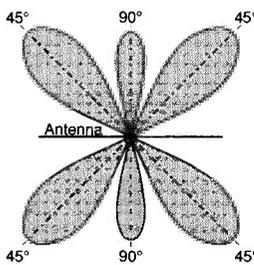

Fig. 3b.

be of little consequence for receiving purposes, it would be a relatively simple matter to add 0.695m of wire to the receiver end of the antenna when using it at 21.600MHz.

## Other Considerations

Although a half-wave antenna can be erected in the inverted-L configuration with comparative ease, such a method is not always convenient or desirable. Perhaps the most undesirable feature of the system is that the end of the antenna has to enter the building to reach the receiver. This means that copious electrical interference from domestic appliances is likely to be radiated by the house wiring and picked up on the antenna. The direct radiation from a home computer or from the line time-base in a colour TV receiver is liable to seriously impair reception. Even if the interference level is low, it may well prevent reception of the weaker signals. Another factor to be considered is that the directivity patterns depicted in **Figs. 2b** and **3b**, which are usually referred to as polar diagrams, will not hold true with an inverted-L system, since part of the antenna is vertical and part is horizontal.

The solution to these problems will depend upon local circumstances but, if space and conditions allow, then the ultimate solution is to erect the antenna as far away as possible from the house, so that it is high up, in a straight line and well clear of surrounding objects. This will involve two supports, such as the

chimney of the house and a pole or tree at the far end of the garden. An r.f. transmission line is then used to convey the signals from the antenna to the receiver, thus obviating the need to bring one end of the antenna wire down into the house.

## Transmission Lines

An r.f. transmission line, usually referred to as a feeder, is designed to convey r.f. energy over a considerable distance with the minimum of loss. There are two main types of feeder. The first consists of two parallel wires which are closely spaced. At any point along the feeder the currents in the two wires are equal in value but opposite in sign. Consequently the field associated with one wire is exactly neutralised by that from the other and radiation, or pick-up, is prevented from taking place. Such an arrangement is therefore known as a balanced (or twin) feeder - see **Fig. 4**.

The second type consists of a conductor supported inside, but insulated from, an outer tube which surrounds it. The outer tube, which can be earthed, effectively screens the inner conductor to prevent radiation or the pick-up of signals, but results in unbalanced operation. Such an arrangement is known as a concentric or coaxial feeder. The outer tube may be formed by plaiting a number of fine copper wires together, so that a flexible coaxial cable may be produced - see **Fig. 5**.

For h.f. applications, the inner

conductor is usually supported by a polyethylene sheath. To reduce losses at v.h.f./u.h.f., a semi-air spaced form of construction may be adopted. This may involve beads or discs of low-loss insulating material or the use of polyethylene foam.

A balanced transmission line consists of distributed constants of resistance (R), inductance (L), capacitance (C) and leakage conductance - see **Fig. 6**. The value of inductance and capacitance per unit length of line depends upon the size of the conductors and the spacing between them. Their values determine the impedance of the line, called the characteristic impedance ( $Z_0$ ), which is equal to the square root of  $L/C$  (neglecting resistance and leakage). A transmission line having almost any value of  $Z_0$  can be produced by using a form of construction which gives the required values of L and C. Close-spaced, large conductors give high C, low L and hence a low value of  $Z_0$ , whereas small conductors give low C, low L and a high value of  $Z_0$ .

The value of  $Z_0$  represents the

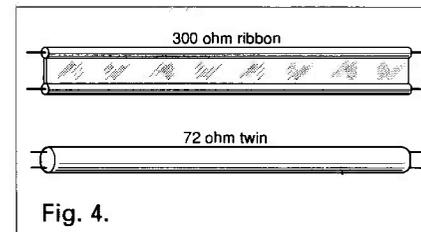

Fig. 4.

impedance of a line of theoretical infinite length. However, a practical line will obviously be very much shorter! Provided a short length of line is terminated with a purely resistive load of value equal to  $Z_0$ , then the line will behave as though it is infinitely long and all of the r.f. energy fed into the line will be absorbed by the terminating load. The line is said to be matched when the current (or voltage) has the same value at any point along the line - correct matching is important if losses are to be avoided. Balanced transmission lines are available commercially in the UK with a characteristic impedance of 72 or 300Ω and coaxial cables are available with 50 or 75Ω values. Exactly how they are used to convey the signals from an antenna to a receiver will be described in a future article. □

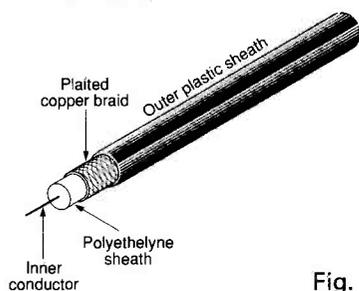

Fig. 5.

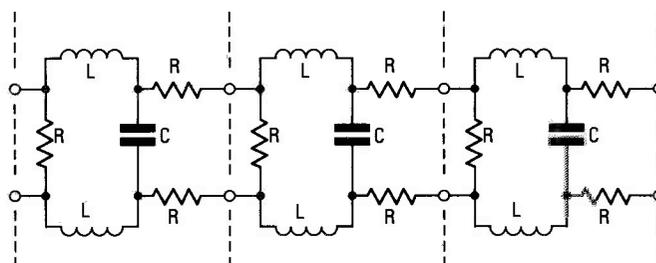

Fig. 6.

# DX LETTER FROM AMERICA

Gerry L. Dexter

Despite the shaky situation in Peru - the guerilla war, the drugs situation and the soaring inflation - new short wave stations continue to come on the air.

One of the more easily heard of the recent additions is Radio Cora, operating on slightly variable 4.915MHz. Sign on is at 0930, sign off at 0505.

Reports are wanted and may be sent to Radio Cora, Centro Civico de Lima, Lima 1, Peru.

## SSB from HCJB

HCJB is now using some 30kW single sideband transmitters once used by the Swiss PTT for communicating with aircraft. Transmissions include 25.950MHz to Europe at 2130, also check 21.460, 21.470, 17.790 and 15.155 at various times. HCJB is anxious to receive reports on these s.s.b. transmissions.

## Station News

A new station in Brazil is Radio IPM, located in the city of Campo Grande in the state of Mato Grosso do Sul. It broadcasts in Portuguese on 4.895MHz. Try around 0000-0200.

The Cuban station Radio Rebelde has added a second channel and is now heard on 3.365 in parallel to its 5.025MHz frequency.

## Dominican Republic Back

Radio Barahona in the Dominican Republic made a brief appearance on 4.930MHz awhile back. Before that the station had announced it would begin operating on short wave using 4.940.

It has not been heard on either of the two frequencies since its first showing. The station's address is Apartado 20339, Santa Domingo.

## Costa Rica

The Spanish National Radio is still in the process of building its relay station in Costa Rica. The broadcaster hopes to be in operation by early in 1991, using three 100kW transmitters. Look for the Costa Rican government radio station to get on the air *via* this facility as well.

## Negev Desert No for VOA

The Voice of America's plan to construct a high power relay station in Israel's Negev Desert has been put on hold by an Israeli court. This go, no-go pattern has now gone round about two times!

**Peru to the Negev Desert, pirate stations to a useful book. Gerry Dexter takes his quarterly look at the DX news from the Americas**

## Low Power WRNO

Commercial short wave station WRNO in New Orleans has been operating at power levels way below its nominal 100kW. The story is that the station's final transmitter tubes need rebuilding.

The current operating power is said to be only 4 or 5kW and there's no indication as to how long it may be before things return to normal. Meantime, even listeners in the United States are having a hard time picking up WRNO's signal.

## Radio Miami International

The Federal Communications Commission has received an application for a new short wave station called Radio Miami International, which would operate from Miami, Florida. The 10kW station would focus its broadcasts on the Caribbean basin and feature an information-music-entertainment format.

Radio Miami International would specialise in covering Caribbean activities, providing extensive weather information when hurricanes threaten, promote tourism in the Caribbean, cover Caribbean-wide events and so on.

The man behind the proposal is Jeff White, a freelance journalist who was the light behind Radio Earth, which broadcast over several stations during much of the 1980s. White also operated Radio Discovery in the Dominican Republic a few years ago.

## Pirate Radio

Pirate radio broadcasting in the US and Canada is expected to set a new record for the amount of activity by the time the end of 1990 is reached. Pirate broadcasting authority George Zeller of Cleveland, Ohio states that 111 pirate stations were tallied as being active during 1989.

By early August 1990 the number of station which has been active on short wave had already passed the 100 mark. Most activity continues to be on weekend evenings and holidays, with 7.417MHz

and vicinity being the most popular spot. The FCC has shut down relatively few of the stations.

## IARN Broadcasts for SWLs

The International Amateur Radio Network (IARN) - a US amateur radio station which makes regular 'broadcasts' of news about amateur radio and associated subjects is now carrying a regular feature devoted to short wave listening.

Hosted by Audrey English, the feature includes guest appearances (Ian McFarland of Radio Canada International was the first). No specific time of day is announced, but the IARN broadcast is on the air daily at 0745, 1100, 1300, 1700, 2100 and 0000 on 3.975, 14.275 and 28.475MHz. On Sundays it is on at 2200 on 3.980MHz and 2300 on 7.920MHz. IARN can be reached by writing to it in the town of Belgrades Lakes, ME 04918. No street address is needed.

## Fine Tuning

Fine Tuning, an organisation of experienced short wave broadcast DXers, has just published the 1990 edition of its *Proceedings*.

The book, like the 1988 and 1989 editions, seeks to present useful and original information for the experienced short wave broadcast monitor and DXer. The 1990 edition runs to some 300 pages and, among other subjects, contains an extensive article on new theories about tropical bands propagation.

Also in the 1990 edition is an extensive collection of modifications for the Sony ICF2010 and 2001D portable receivers, a guide to using your library as a DX tool, a look at synchronous detection and the benefits it can provide for short wave DXing, a review of the Kenwood R-5000 receiver, a feature on DXing Central America and another on Africa's Sahara and Sahel.

The book costs US\$19.50 plus \$3 shipping via surface mail, in US funds only. It may be ordered from Fine Tuning Special Publications, c/o John Bryant, RR5, Box 14, Stillwater, OK 74074, USA. Bank drafts should be in US funds and payable to Fine Tuning Special Publications. Fine Tuning and its publications are a not-for-profit endeavour.

That covers things for this time. Your comments are welcome *via* the *SWM* offices in Poole and meantime, I'll be back with another DX Letter From America in three months time.

**FOR LISTENING NEWS AND INFORMATION RING RADIOLINE  
0898 654676**

Calls charged at 33p per minute cheap rate, 44p per minute at all other times.

# dressler

COMMUNICATIONS LTD.

AMEX

RSGB

MON-FRI 9.0-5.30  
SAT 9.30-4.30

## DRESSLER ACTIVE ANTENNAS

### ARA 30

ACTIVE ANTENNA  
50kHz...  
40MHz WITH LIMITED  
PERFORMANCE UP TO  
100MHz

Professional electronic circuitry with very wide dynamic range. Meets professional demands both in electronics and mechanical ruggedness. 1.2m long glass fibre rod. Circuit is built into waterproof 2.5mm thick aluminium tube. Ideal for commercial and swl receiving systems. £139. See review in Practical Wireless August 1985 issue p.35. Both antennas come complete with 7 metres of cable, interface, power supply and brackets.

£139

### ARA 1500

50MHz - 2GHz

Frequency	Gain
50-1000	11.5dB
100-1500	11.0dB

£159.00

'N' Connection

Now fully tuneable interface. Intercept point + 21dBm Typical.

191 FRANCIS ROAD  
LEYTON • E10 6NQ • LONDON

TELEX 8953609 LEXTON G

Phone 081-558 0854 081-556 1415

Fax 081-558 1298

24hr Hotline ansaphone 081-558 0854

Or contact your local agent any time on the following

numbers: Stewart (Bromley, Kent) 0860 634526,

Terry (Biggleswade, Beds.) 0767 316 431.

## YAESU



YAESU  
FRG  
8800

FRG 8800 HF RECEIVER  
£585.00

VHF CONVERTER £100.00



YAESU  
FRG9600  
50 - 950 MHz  
£500.00

## KENWOOD

R5000 HF Receiver only ..... £799

R5000 + ARA 30 ..... £899

RZ1 Mobile scanner 500 KHz - 905MHz ..... £459

## ICOM

### ICOM R71

General Coverage Receiver  
£855



FIRST CLASS SHORT WAVE RECEIVER.

BUY THIS FOR £855 AND RECEIVE AN

ARA 30 FREE. WORTH £139.

ALSO R7000 complete with

ARA 1500 £999.

Icom R72 now available. P.O.A.  
ICR 9000 150kHz - 2000 MHz inc. ARZ 30+  
ARA 1500 and delivery ..... £3995

## SONY

SONY ICF 2001D

76 - 108MHz 116 - 136

Airband

153kHz - 29.995MHz

FM-AM-SSB 32 MEMORIES

INC. PSU, CARRY STRAP

AND EARPHONE

£299



Complete ICF2001D system including all above,

plus AN 1 ..... £349

Sony Air7 ..... £229

Sony Pro 80-150 kHz, 115-224MHz,

AM-FM-SSB ..... £299

Sony An1 Active Antenna ..... £55

Sony AN3 Airband Antenna ..... £53

76-108MHz

SONY SW 7600DS

New Model ICF-SW7600DS featuring stereo

FM + USB/LSB and larger display ..... £165.00

76-108MHz

153kHz-29.995MHz

Complete with case,

mains power supply,

earphone and frequency list.



## STANDARD



STANDARD

AX700

PANADAPTOR DeLuxe

£575.00

### SPECIAL PRICE

NRD 525 Receiver

£950

Grundig 500 ..... £280

ICOM R1 ..... £399

ICOM R100 ..... £499

AOR 1000 ..... £249

AOR 2515 ..... £575

AOR 2002 ..... £459

AOR 3000 ..... £695

# Bredhurst electronics



BREDHURST ELECTRONICS LTD.

High St, Handcross, W. Sx. RH17 6BW

(0444) 400786

SITUATED AT SOUTHERN END OF M23 - EASY ACCESS TO M25 AND SOUTH LONDON

### RECEIVERS

HF225	£425
ICR71	£855
R2000	£595
VC10VHF Converter	£161
FRG8800	£649
FRV8800 VHF Converter	£100
R5000	£875

### HF TRANSCEIVERS

TS950SD	£3199
TS940s	£1995
TS440s	£1138
TS140s	£862
TS680s	£985
FT767GX	£1599
FT757GX2	£969
FT747GX	£659
IC765	£2499
IC751A	£1500
IC735	£979
IC735	£979
IC725	£759
IC726	£989

### 2M TRANSCEIVERS

TH25E	£238
TH205E	£199
TH215E	£228
TR751E	£599
TM231	£289
FT411 + FNB10	£259
FT290R11	£429
FT211RH	£309
FT212RH	£349
IC26E	£265
IC228H	£385
IC275E Inc PSU	£1069
IC25E	£275
IC25ET	£295

### 70CMS TRANSCEIVERS

TH405E	£245
TH415E	£268
TM431E	£318
FT790RH	£499
FT711RH	£349
FT712RH	£375
IC4GE	£299
IC4SE	£310
IC448E	£429

### DUAL BAND TRANSCEIVERS

TM721E	£699
TS790E	£1495
FT470R + FNB10	£384
FT736R	£1199
IC32E	£399
IC3210E	£499
IC2400E	£635
IC2500E	£675
IC24ET	£385

### SCANNING RECEIVERS

ICR7000	£989
FRG9600M	£509
Icom IC R100	£499
AR2002	£487
R535 Airband	£249

### ANTENNA TUNER UNITS

FRT7700	£59
FC757AT	£349
AT230	£208
AT250	£366
ICAT100	£379
MFJ941D	£116
MFJ949C	£165

### DATONG

AD370 Active Antenna	£77.62	3.00
FL3Multimode Filter	£145.54	2.00
D70Morse Tutor	£63.40	2.00
ASP Speech Processor	£93.15	2.0

### COAXIAL SWITCHES

SA450 2way SO239	£19.49	1.50
SA450N 2way N	£26.99	1.50
Drae 3way SO239	£20.18	1.50
Drae 3way N	£26.11	1.50
C54 4way BNC	£30.39	1.50
MFJ-1701 6way SO239	£38.35	1.50

### HAND HELD RECEIVERS

RE375 Airband	£69.00	2.00
ICOMICR1	£399.00	2.00
Win 108 Airband	£175.00	2.00
AOR AR1000	£249.00	2.00
Yupiter MVT-5000	£299.00	2.00



### AR-1000 Handheld Scanner

- \* 1000 Channels
- \* 8 - 600MHz continuous
- 805 - 1300MHz continuous
- \* AM, FM (narrow & wide)
- \* Complete with NiCads and mains charger

£249

GOODS NORMALLY DESPATCHED WITHIN 24HRS - PRICES CORRECT AT TIME OF GOING TO PRESS - E&OE

MAIL ORDER & RETAIL

### SELECTION OF ANTENNA RANGE

J Beam 'Minimax' Triband	£378.35
J Beam TB3MK3 Triband	£365.70
Butternut HF6VX	£182.95
Butternut HF2V	£163.30
Cushcraft A3 Tribander	£329.00
Cushcraft 2M 215WB	£99.00
Tonna 20505 Sele 50MHz	£50.72
Tonna 20809 Sele 144MHz	£33.12
G Whip tribander 10, 15 and 20m	£44.39

### MORSE KEYS

KENT MORSE KEY KITS  
HIGHMOUND  
BENCH PADDLE KEY  
AVAILABLE FROM STOCK

### ANTENNA PRODUCTS

R-X Noise Bridge for antenna checks up to 100MHz	£59.95
Receiver Preamp - 1.8 to 54MHz. Up to 20dB gain	£119.95
Transceiver Preamp - R.F. Switched - up to 20dB gain	£149.95
Super Snooper - vertical indoor antenna for SWL	£39.95
Loop antenna - Directional indoor antenna 6 loop ranges phone for details	
Tuner Tuner - ATU adjustment without transmitting	£99.95
SWR & Power meter - LED display SWR without adjustment	
20W 200W 2000W PEP	£129.95
2W 20W 200W 2000W PEP expanded display	£189.95
VLF converter - 10 - 500kHz converter	£79.95
Baluns 350W PEP 1.7 - 30MHz	£23.95 each
1.1, 1.5, 2.1, 3.1, 4.1, 5.1, 6.1, 7.5, 9.1, 12.1, 16.1	
Baluns - up to 6kW PEP phone for details	

BREDHURST ELECTRONICS LTD HIGH ST, HANDCROSS, W. SUSSEX. RH17 6BW (0444) 400786

Open Mon-Fri 9am-5pm except Wed 9am-12.30pm. Sat 10am-4pm

# JAVIATION

VHF/UHF AIRBAND SPECIALISTS

0274-732146



MVT 5000



AOR AR2515

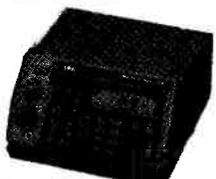

AR 1000/HP 100



With equipment from AOR, Fairmate, Yupiteru, Icom, Signal, Sony, Uniden Bearcate, Revco, Win, Black Jaguar, Tandy/Realistic and others we offer one of the widest ranges of receivers suitable to the airband enthusiast. For information or advice please give us a call and have a chat or send a large SAE for a catalogue.

Frequency lists, Our UHF & VHF airband lists are produced and amended regularly, enabling us to keep them as up to date as possible. Our VHF list includes LATCC transmitter sites/frequency tie ups, squawk, codes, and the ICAO 3 letter airline decode.

Our UHF list is probably one of the most comprehensive available and is updated regularly to keep pace with the changes. - How many have the new Eastern frequencies?

### AOR900 ACCESSORIES

Spare battery packs £15.50

Robust leather carry cases £25.00

Second hand: our secondhand equipment changes all the time, if you are after a particular set please give us a call - we might have what you are after.



JAVIATION



JAVIATION

UHF - £2.00

VHF - £3.00

## JAVIATION

CARLTON WORKS, CARLTON STREET, BRADFORD.

WEST YORKSHIRE BD7 1DA

TELEPHONE: 0274-732146 FACSIMILE: 0274 722627



EURO - AM LIMITED

## Multi-Standard C.T.V. & Videos

8 SYSTEMS: PAL (1) - PAL (11) - PAL 60 - SECAM - NTSC  
NTSC 4.43 - NTSC 3.58 - NTSC 50

Hitachi C.T.V.s Model CMT 2060

4 SYSTEMS: PAL - SECAM - NTSC - NTSC 4.43

Hitachi VT39EM Videos

NTSC 3.38 - NTSC 4.43 - PAL - MESECAM - SECAM

TELEPHONE: (0827) 52491



### VHF & UHF ENTHUSIASTS



Our Audio Switch Unit will link your RX & Tape Recorder to collect signals while you sleep or work. A boon to Airbanders Requires 12V, DC @ 60mA. SUPPLIED BUILT & TESTED COMPLETE WITH AUDIO LEADS ACCESS & VISA £48.95 inc P & P Or send S.A.E. for details to: AEROTRONIC CONTROLS LTD HALESFIELD 22, TELFORD, SHROPSHIRE TF7 4QX. (0952) 586329

## MEDIUM WAVE LISTENERS

DO YOU ENJOY DXING THE MEDIUM AND LONG WAVE BANDS? THEN **MEDIUM WAVE NEWS** IS FOR YOU. THE ONLY SPECIALIST MAGAZINE FOR THE MW/LW LISTENER IS AVAILABLE BY SUBSCRIPTION FROM: **THE MEDIUM WAVE CIRCLE, 137a HAMPTON ROAD, SOUTHPORT, MERSEYSIDE PR8 5DY** (SAE for full details, or for sample copy of magazine send 60 pence in stamps or 2 IRCs)

# JOHNSONS SHORTWAVE RADIO

## LEADING THE WAY YET AGAIN

### TMR 7602 HITECH TATUNG

(SANGAN AT5803A MIKII IMPROVED)

#### SPECIFICATIONS & FEATURES

- ★ 150-29.999 continuous tuning with no gaps. Phase locked loop-double conversion Superheterodyne.
- ★ Full Shortwave/Am/SSB 150-29999 KHz No Gaps! + FM 87.5-108 Mono/Stereo. ★ Five Tuning Functions: Direct Press Button Frequency Input Auto Scanning, Manual Scanning Memory Recall and Manual Tuning Knob. ★ Built-in Clock and Alarm, Radio Turns on Automatically at preset time & frequency. ★ Large digital frequency display. ★ Fourteen Memories - Nine Memory Channels For Your Favourite Station Frequencies. - Last Setting of Mode & Waveband Stored in 5 Memories. ★ Direct Press-Button Access To All 12 Shortwave Broadcast Bands. ★ Two Power Sources - Battery or AC Mains Adaptor. ★ General Coverage of all AM Bands in LW/MW/SW (Dedicated Broadcast Band Coverage on all Versions) Plus of Course The FM Band for Quality Sound Broadcasts in Headphone Stereo. ★ SLEEP Function Turns the Radio On or Off After an Adjustable Time of 10-90 Minutes. ★ Separate BASS & TREBLE Controls for Maximum Listening Pleasure. ★ External Antenna Jack for Better Reception. ★ Adjustable RF GAIN Control to Prevent Overloading When Listening Close to Other Strong Stations or if There is Interference. ★ New improved wide/narrow filter (6/2 7kHz) ★ BFO Control (Beat Frequency Oscillator) Enables Reception of SSB/USB/LSB (Single Side Band) and CW (Morse Code) Transmissions. ★ Illuminated Display to Facilitate Night-Time Use. ★ Designed for Both Portable and Desk Top Use. ★ Five dot LED Strength Indicator.
- ★ Dimensions:- 29.2cm x 16.0cm (11.5in x 6.3in x 2.36in)
- ★ Output:- 1200 mW (10% THD). ★ Weight:- 1.7kg. (3.75lbs) Without Batteries.
- ★ Wide/Narrow Filter Switch

£109.99

COMPLETE WITH MAINS POWER

&

FREE GIFTS ★  
SONY SHORTWAVE GUIDE  
STEREO HEADPHONES  
100 PAGE FREQUENCY BOOK

£8 CHECK/TEST/POST & PACK

OPTIONAL CARRYING CASE £14.99 + £1.50 p&p

Also suits a Phillips D2935, Grundig 400/500, Sony 2001D and similar sized radios. Sangan AT5803A, Matsui 4094, Saisho - Realistic DX440

#### 'EDITORS' CHOICE'

Passport To Worldband Radio  
(Larry Mange 1990)

### ITC-R610 SABINA

10 WAVEBAND  
GLOBAL RADIO  
MAINS AND BATTERY

£44.99 + £5 carriage with long range shortwave aerial and earpiece.

### Russian VEGA 215

MK4 SELENA

'Latest Release'

£46.95 + £5 carriage complete with long range shortwave aerial & earpiece

### GRUNDIG

500 & 650 Satellit's

220 & 230 Yacht Boys 'ALL IN STOCK' Ring for prices.

### Sony Active Aerials

in stock & Demonstrated.

### IMPORTANT ANNOUNCEMENT!

Our Sony ICF 2001D Radios are the new modified version with Static Discharge Protection and can be safely and confidently used with any External Aerial or Earth: order 2001D/P.

We also give **2yrs warranty** with this and many other **Sony SW Radios.**

SWL 'ATU' matches any aerial to any radio £36 + £4 P&P

Want to get the best out of your portable? S.W.L. DX Aerial complete **£10.95 + £3.50 P&P.** Suits Matsu, Saisho, Philips, Sony, Panasonic, Realistic, etc., etc., etc.,

**G5RV FULL SIZE 10-80 Mtrs £16.50 + £3.50 P&P. 1/2 Size £14.50 + £3.50 P&P.**

S.A.E. ON ALL CORRESPONDENCE. SORRY BOYS. NO STAMP. NO REPLY! PRETTY GOOD CATALOGUE £1.00 + 50p p&p LOTS AND LOTS OF GEN

WE GIVE SPECIALISED & PERSONAL SERVICE BY SWL LISTENERS FOR LISTENERS  
REMEMBER WE'RE AT 43 FRIAR STREET, WORCESTER WR1 2NA. Tel: (0905) 25740

WE ARE CLOSED ON THURSDAYS ALL DAY

STOP PRESS...JUST PRINTED: IRAQ/KUWAIT FULL FREQUENCY INFO PACK £4.99 post paid.

FULL GEN ON US FORCES RADIO NETWORKS (THE LOT).

WHY NOT GIVE US A CALL, OR COME ON DOWN, THE PRICE IS RIGHT!



# SEEN & HEARD

## AMATEUR BANDS ROUND-UP

Paul Essery GW3KFE  
PO Box 4, Newtown, Powys SY16 1ZZ

Last evening at the club, we were discussing the eternal question of the Morse requirement for a Class A licence. First, let's be quite clear about one thing: the Morse requirement is embedded in International Law - amateur radio is, in fact, so far as I know the only hobby so regulated. So just bellowing won't cause a change!

Originally, and up to about the late fifties, the choice was a.m. telephony, just like the local broadcast station, or c.w.. If you listened on 14MHz 'phone, the cacophony of carrier heterodynes was quite unbearable. To make matters worse the 'talk power' of the a.m. signal was some 9dB less for a given output stage. Thus the strong signals weren't so strong and the weaker ones were buried under the heterodynes. The 'phone DXer who had 100 countries booked in was a relatively rare bird.

To make things a bit more difficult yet, the a.m. signal needed, as does the modern s.s.b. signal for that matter, to poke up out of the noise by enough dB to enable enough of the amplitude variation to be recognised by the listener along with the different frequencies, for speech to be understood. So far, so good.

So the operator could tire of the cacophony and turn to c.w. Now suddenly the world was his oyster. Why?

Basically, because to receive c.w., he had to switch on a b.f.o. Everything in the receiver was now detected by comparison with the b.f.o. signal which in turn was bigger than the QRM whistles. Secondly, because the operator could sharpen up his selectivity to remove much of the QRM. Thirdly, because any remotely capable operator could not only copy a c.w. signal barely above the receiver noise floor, but he could even carry on getting decent copy when the signal was several dB below the noise! What happens is that with key down the noise sounds sufficiently different from the key-up noise for the c.w. to be copied; in fact you can see the effect on an oscilloscope.

Again, since Morse is sent by keying a carrier wave on and off, it follows that the brain can be brought further into the reception system. For example, one can differentiate between, say a weak signal having a beat note of 400Hz with a louder one having a beat note of say 1kHz, entirely in the brain. This is not possible with any form of telephony simply because a speech waveform is already an amalgam of lots of frequencies, so that part of the brain is otherwise occupied.

Summing up then, there is a significant gain, technically, from the use of c.w. A signal that would be too weak to copy even on s.s.b. will be a handsome one on c.w., on a.m. the

comparison is even more marked.

What about f.m. and the modern 'digital' modes? First f.m. Undoubtedly f.m. telephony gives the best speech quality. However, the 'capture effect' says that a strong f.m. signal will 'capture' a weaker one and the latter will become inaudible. Handy when the v.h.f. mobile on the M62 is working into both the GB3RF and the GB3PW repeater at once, but not much use at other times! Of the various digital modes, perhaps the most effective in this context is AMTOR, particularly when working in the error-correcting mode; but I don't think even its most confirmed addicts would expect it to be as effective as simple on-off keyed Morse at the same power levels. The others are almost without exception 'big-signal' modes.

So what?, you ask. Over the past couple of decades we have grown to be digitally minded. We stretch out credibility in order to turn a signal which needs linear amplification and processing, in order to process it digitally and we lose performance in the process. Digital techniques are a dead-end in terms of amateur radio communication. It seems to me that the way ahead is through frequency-hopping techniques on the one hand, and 'coherent' modes on the other. Hopping gives more immunity from QRM, given that your hopping routine isn't copied by another signal on the same frequency. Coherent c.w. is already well proven as enabling Morse reception at levels below conventional c.w. limits; all that is needed is to develop a method applicable to general use.

And, of course, the real reason why some are addicted to c.w. is much more simple; once you have learnt the new language you are into a different community. Having been in some way forced to learn the code up to a fluent standard by some means or other, the operator suddenly finds it much more rewarding to stick to it. In most cases, he doesn't much bother with 'phone other than for the local nattering. This moment of conversion seems to occur once the operator has learnt to accept that the '100% copy' requirement of the Morse test doesn't apply on the bands any more than it does on 'phone, and secondly when his mind begins to 'store' the stuff coming in on c.w. just as it does on 'phone.

### What's On

The equinox lift will be all but over by the time you get to read this, and the slide into winter conditions beginning. Brrr!

JX7DFA will be active until mid-April from Jan Mayen. Operator LA7DFA will be concentrating on 28MHz and the l.f. bands, mainly c.w.

I hear the Kenyan government do not intend to renew expatriate's amateur licences. Kenyan nationals not affected. That'll put Kenya into the rare DX category!

Rumours still abound of a ZA, Albania operation; me, I'll believe that when I have the QSL in my hand!

For the more up-to-date stuff, lend an ear at regular intervals to *Wireless Line* which is updated by *Practical Wireless* at regular intervals.

### Letters

How nice to hear again from **A. P. Ashton** (Stowmarket). Phil was an s.w.l. reader back along some twenty years or more ago, who eventually became G3XAP and a regular contributor to my DX column in the old *Short Wave Magazine*, now transferred to our sister publication *Practical Wireless*. Nowadays, Phil transmits on the transmit-half of a KW2000B and receives by way of a Racal RA117E. The only snag with the latter is complication when realignment is necessary, and on the other hand the need for a fork-lift truck to move the thing about!! In conclusion, Phil reminds me that he owes me a pint.... a delightful thought.

**Ian Clucas** hails from Chorley, and recently got hold of a SW5000 receiver, and has been trying to listen to stations in the Gulf for news of recent events, with no success. Radio amateurs in the Kuwait and Iraq area are, if they have any sense, going to stay off the air until the present position is resolved. As for commercial stations, they usually have several outlets and frequencies to cope with changing seasonal and sunspot conditions. Of course, one must listen for them at the times when they are active. Perhaps the best guide is a current copy of the *World Radio TV Handbook* from the SWM Book Service. As for time, on the higher bands something around 1600 wouldn't be far off the mark.

Ian's second question concerns some Indian music heard on 15.335 and 12.085MHz during the day; again a reference to a current copy of *WRTH* against the given frequencies should at least reduce the possibilities down to a short list.

**Harold Wood** (Gorton) has been listening on 14, 21, 28MHz. On 14MHz, he logged IN3PEU, EP2HZ, EK3DA/MM, C30EMA, 5H0QL and DK3GM/P. On 21MHz there were EFC7DPT, W2GM, W2BAI, K2QAU, W3KDD, KA4RHH, UB5CDX and CU2EL. As for 28MHz, W8CXO, RA6AH, OY3ZH, W2GDY, PY7ZZ and W4YHB all entered the headphones.

**E. H. Trowell** (Minster) reckons he should be able to spend a bit more time on Top Band this autumn; in the summer Ted's noise level is S9 or higher. Meantime, on s.s.b., there were loggings such as ON7BW on Top Band, ZL3FV on 14MHz, W4GXT and N4HHH on 21MHz. On c.w., Ted noted signals on 1.8, 3.5, 7, 10, 14, 18, 21, 24 and 28MHz bands, with all the continents represented.

**B. J. Salt** (Harlow) is mainly interested in antennas, but recently attention has been diverted to a shack rebuild, thanks to the acquisition of a couple of wooden record racks otherwise destined for the town dump. Now, there is a nice convenient placement of all the main items plus places for sundry p.s.u.s, paperwork, spare valves and whatever. There is now even room to write a letter or do a bit of soldering!

**Andrew Marriott** (Bath) is another who contributed to the s.w.l. column in *Short Wave Magazine* back in the sixties when he was still a schoolboy. Nowadays Andrew is mainly interested in what he can wrinkle out on 18MHz c.w., which this month included VE2PA, VE7QU, VE37SR, NR5Q, KC0AQ, WK0B, KB6NRL, W6VD, W7ELH, W7QK, UI8LA, JA8BB and KL7CYL.

Another 18MHz fan is **Vince Cutajar** (M'Scala, Malta), who managed HA0HW, ZL2BCG, HL1UA, FS/PA0CRA, V51P, HK5LEX and T5RR; on 24MHz there wasn't so much but Vince did pick up N9AAL, OZ7MY, CT1TM, SM5OMP and DL5CBW on August 29.

Now to **Charles Wells** (Mansfield) who seemed to be in mortal combat with his new electronic typewriter.... the machine is fighting back strongly! Seriously, Charles mentions A92BE, 3C1EA, 4S7WP, V47NXX, W3TZW, WB2AGT, N5CB, JA21VY and 7X3DA. Charles reckons the 'con' of the month award goes to the F6DYY/P48, heard in the bottom of a pile-up. Thinking he had hooked a station in Aruba, off went a direct QSL card plus IRCs. In due course the card came back, and turned out to be a portable station operating in Department 48!

**Mike Drew** of Wrexham mentions 28MHz, where he logged CX9AAW, A22AA, IK4MRI, IK6CAC, YQ2CWL, HB9ATA, HG7JBF, I5TZR, I6SRP, F5GT, DL1IAR, G0NOR, KA1OWG, Y24UH, SM4RFDG, GW0DYG, and OE5DI/50A. A little lower, on 21MHz there was a mite more DX about: VK2FMW, VU2TTC, RA3QG, TA2KA, 9M2CW, UJ8JJ, UI8ZAC, DU2USK, TU2UI, ZS5S, DL0GM and S92LB.

**For the latest DXpedition news you can always ring Wireless Line (compiled by Practical Wireless) on 0898 654632.** Calls charged at 33p per minute cheap rate, 44p per minute all other times.

Practical Wireless have organised a trip to the Dayton Hamfest in 1991. Anyone interested in details of this trip, which will cost £499 for the five day trip, should send for further details. Book early as the number of places is very limited. Bookings will be dealt with on a first come first served basis.

The price is based on two people sharing a twin bedded room. Not included in the price, but highly recommended, is an optional medical insurance cover at a cost of £30.

# SEEN & HEARD

## DECODE

Mike Richards G4WNC

200 Christchurch Road, Ringwood, Hants BH24 3AS

**Maurice Lloyd** of Blackpool, like many of us, has been monitoring the Middle East press agencies for news of the Gulf. Maurice had a particular interest as he was approached by a Blackpool family who had relations caught up in the crisis. Unfortunately, he didn't have a lot of success as the BBC World Service is being jammed and the press agencies are just sending out general news. I wonder if any readers have received any interesting reports during this crisis? If so please drop me a line with the details.

Maurice also reports the CETEKA Prague frequency, 17.525MHz, seems to be currently occupied by GXQ London. Have any other readers experienced this?

**David Wilkins** writes from Harrow Weald asking for help with a software problem. He has recently borrowed a Triumph-Adler Alphatronic computer and is looking for RTTY, AMTOR and weather satellite software. The operating system used on this computer is CP/M which may well be the saving grace. Probably the best starting point is the Public Domain Software Library as I know they keep a good range of CP/M disks. One of the problems with a machine such as this is the wide range of hardware variations that exist. Most data decoding programs have to address the machine hardware directly and so often by-pass the operating system BIOS. This means that although the program may appear to run OK it may not be able to find the serial port. If anyone has any ideas that may help David, just drop me a line and I will pass the details on. The address for the PDSL is: Winscombe House, Crowborough, Sussex TN6 1UL.

David's final request is for a recommendation of what is the lowest cost IBM PC compatible that will run a wide range of software. This innocent question is not at all easy to answer. My suggestion is that you first get an idea of which programs you would like to run and then check with the suppliers on what they recommend as an economy machine. That way you should be assured of success.

**Robert Hall** of Cape Town, South Africa is a very keen listener and has written with an update on his equipment. The main receiver is an Icom R-71E that is fed by one of three antenna systems. These are a ZSRX vertical whip, a home-made vertical helical and a 35m long wire. The main decoder is the Universal M-7000 multi-mode device, which feeds a video monitor and a Seikosha printer. Additional supporting equipment consists of a Sony 2001D receiver, Tasco Telereader CWR-685, Sony Air-7 and a Kenwood RZ-1.

Robert's favourite 'toy' at the moment is the newly acquired M-7000 decoder which can handle a very wide range of different modes. He reports very good results, though he expects to have to spend the next six months building up experience!

Robert also asks where to find Reuters and US press agencies. Most of these transmissions have now

moved from h.f on to satellite systems. Unfortunately I don't have details of the frequencies, but if anyone can help, I would be very interested.

One final point from Robert, concerns the use of standard names for the various utility modes. I think this is a very good point and one that we ought to sort out in this column. Just to illustrate the point, one common mode that is represented in many different ways is SITOR. Here is a sample of some of names you might find: SITOR, ARQ, AMTOR, CCIR 476 to name but a few. So what are your ideas as to what we should use?

**Paul Mately** of Blackpool is an experienced listener who has recently turned to utility monitoring. His equipment comprises a Yaesu FRG-7700 receiver fed with a long wire antenna. For decoding he uses the popular RX-8 package from Technical Software with his BBC master computer. Paul's main interest is in FAX reception and it is here that he has hit a problem - receiver drift. This is a problem that affects most FAX operators in some form, depending on the quality of the receiver. If you are sitting with the receiver as you receive the FAX there isn't too much of a problem as you can trim the frequency drift manually. It's when you use the automatic FAX reception modes that the receiver stability becomes critical. The solution, in most cases, is to make sure that your station is powered up a couple of hours before the operating session. Another point to watch is that your receiver operates in a steady temperature and is protected from draughts. This is because frequency drift is usually temperature sensitive.

Many FAX enthusiasts have found the Meteosat pictures that are re-broadcast from Offenbach Meteo on 134.3kHz, to be very useful. Paul, along with many others, is having difficulty with an adjacent interfering signal. The signal has a sound similar to a sonar signal, but appears to be low speed data. The main problem is that the interfering signal is centred on a frequency just 2kHz lower than Offenbach. If you have variable i.f. filtering on your receiver you should be able to reject the interference quite easily. For those without this filtering it can make Offenbach impossible to receive. I would be pleased to receive your comments on this problem and any solutions that may have been found.

Finally from Paul is a comment on the quality of the Associated Press transmissions from Buenos Aires. These press photos have been hammering in with very good signal strengths in the evening and consequently good picture quality. The frequencies to watch are 17.762MHz (LQZ67) and 20.736MHz (LSA600).

### Station Details

I have received a whole range of information from several readers that I thought you might find interesting.

The first comes from **Maurice Lloyd** and covers the Romanian news

agency Rompres. This station is headquartered in Bucharest and transmits press bulletins in English and French. The transmitters are 15kW and use a double horizontal rhombic antenna system. The frequencies and schedules are listed here:

6.972MHz 1630 - 1800UTC, English  
6.972MHz 1800 - 2000UTC, French  
9.797MHz 0900 - 1000UTC, English  
9.797MHz 1000 - 1100UTC, French  
12.11MHz 1100 - 1230UTC, French  
21.808MHz 0730 - 0830UTC, English.

The transmission mode is 50 baud RTTY with a 425Hz shift.

**Jan Nieuwenhuis** has supplied me with details of the Beijing Meteo schedule. This station, although a long way away, is often a very good signal in the UK so is worth keeping an eye on. The frequencies and call signs used are as follows:

5.525MHz (BAF6), 8.120MHz (BAF36), 10.115MHz (BAF4), 14.365MHz (BAF8), 18.235MHz (BAF33)

The format for all these transmissions is 120 r.p.m. and an IOC of 576. Here's the latest schedule: 0140UTC, 0740UTC, 1340UTC, 1940UTC, Typhoon warning in English & Chinese.

1000UTC, Typhoon track forecast.

1020UTC, Test Chart.

1027UTC, Programme amendments

Incidentally the typhoon warnings are well worth printing.

Finally, from **Day Watson** of Clevedon, comes details of Australian weather FAX service. The service uses two transmitter networks known as Melbourne Broadcast and Darwin Broadcast. However, in the case of Melbourne Broadcast the transmitters are located in Canberra. The technical details of these stations are as follows:

#### Melbourne Broadcast

AXM31 2.628MHz 1100 - 2100UTC

May - July

AXM31 2.628MHz 1700 - 2000UTC

August - October

AXM32 5.1MHz 24hrs

AXM34 11.03MHz 24hrs

AXM35 13.92MHz 24 hrs

AXM37 20.469MHz 24hrs

Power 5kW; IOC 576; 120 r.p.m.

#### Darwin Broadcast

AXI32 5.755MHz 1100 - 2300UTC

AXI33 7.535MHz 1100 - 2300UTC

AXI34 10.555MHz 24hrs

AXI35 15.615MHz 2300 - 1100UTC

AXI37 18.06MHz 2300 - 1100UTC

Power 10kW; IOC 576; 120 r.p.m.

The full chart schedule is too lengthy to include here. However, if you want to receive it off air, the transmission times are 0115 - 0130UTC for Melbourne and 0030 - 0045UTC for Darwin. If you have a particular interest in this service, they can supply a very informative booklet which details all the schedules. This booklet also gives a breakdown of all the abbreviations used. The address to send to is included in the QSL address feature in this column.

### QSL Addresses

With the growing popularity of QSLing with utility stations, I thought

the following list of confirmed addresses would be useful.

Australian Bureau of Meteorology, Director of Meteorology, GPO Box 1289K, Melbourne, VIC 3001, Australia.

Beijing Meteo, State Meteorological Administration Communications Station, Baishiqiaolu No 46, Western Suburb, Beijing, China.

Chuo Radio, Central Fishery Coast Station, 21-20-3, Futawahigashi, FUNABASHI-CITY, Chiba Pref., Japan.

French Navy Dakar, Marine Nationales Service T.V.L., Etablissement Interarmees des Transmissions de Yeumbeul et de Rufisque, Station de Reception Dakar-Yeumbeul, Attn: Chef de Station, BP 3024, DAKAR

French Navy Fort-de-France, Station Radio Pointe des Sables, F-97261 Fort de France Naval, Martinique.

Grengel Meteo, Amt fuer Wehrgeophysik, Beratungszentrale-T3, Funksendestelle DHJ51, Postfach 902500/507, D-5000 Koin 90, Germany.

Kaohsiung Radio, Maritime Radio Telegraph Coastal Station, 142 Jiin-Tien Road, KAOHSIUNG, Taiwan, Attn Station Master.

Manila Radio, Microwave Communications Incorporated, Suite 413 Gedisto Centre, 1564 A. Mabini Street, Ermita, MANILA, Philippines.

### Yaesu RX Software

Regular readers may remember that some months ago I mentioned a software package that Simon Collings G4SGH had written. This was designed to run with the FRG-8800 receiver and enabled computer control of the main receiver functions. Since the original review, the program has undergone many changes and has been developed in to a commercial product. The key features are:

Keyboard Frequency Entry  
10 selectable tuning steps  
1000 commented memory channels

Manual/auto memory scanning  
Comprehensive logbook  
Optional Morse id of mode  
Supports 8800 v.h.f./f.m. options  
Tuning using arrow keys.  
Ten channel seven day timer  
An h.f./v.h.f. bandplan display  
On-screen help  
Dual v.f.o.s per channel  
Supports FRG-9600 freq. display  
Supports mouse control.

There are many other features so for more information watch for adverts in SWM. Alternatively drop a line to Barrie Jenkins, 32 Marsh Crescent, High Halstow, Kent ME3 8TJ. He is marketing the package.

### Frequency List

As is usual here is a selection of this months loggings for you to try. The format is frequency, mode, speed, shift, call sign, time and notes.

4.562MHz, CW, - , - , J.W.T., 2110UTC, Stavanger  
6.752MHz, CW, - , - , ?, 0828UTC, UNID Air

# ENTERPRISE ERA RADIO APPLICATIONS LTD.



NOW WITH  
VERSION 3  
SOFTWARE

ERA LTD  
26 CLARENDON COURT  
WINWICK QUAY  
WARRINGTON WA2 8QP  
Tel: (0925) 573118.

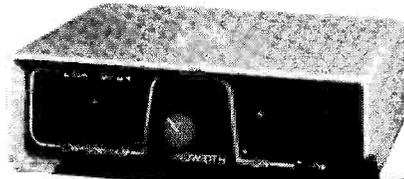

Price £99.50

SEE  
REVIEW  
PW SEPT 89

## BP34

The BP34 audio filter helps you hear weaker stations by eliminating adjacent channel & wide band noise interference. A must for SWLs/Contest groups/CW operators/Weather Fax users.

Easy to connect & use but despite its apparent simplicity, the BP34 has the highest performance specification of any filter you can buy. Exceptionally sharp cutoff, 80dB of stopband rejection & less than 0.3dB passband ripple makes the BP34 more versatile than a whole set of expensive crystal filters!

To order or for more information ring or write. We are open Saturdays for personal callers.

Also available from:

Electromart	— Swansea	Third Eye	— Aberdeen
Flightdeck	— Stockport	Wants	— Plymouth
Johnsons SW	— Worcester	Ward Eiect	— Birmingham
R.A.S.	— Nottingham	Waters &	— Hornchurch
Star	— Tyne & Wear	Stanton	— Essex

All Products unconditionally guaranteed for 2 years.



All prices  
include VAT  
& P&P

£154.95

## MKII MICROREADER

The Microreader is a small compact unit that allows anyone equipped with a suitable SW receiver, to read Morse & RTTY signals simply and without fuss. No computers, interfaces or program tapes are needed, just connect the Microreader to the ear or speaker socket & switch on. The decoded words appear on the built-in 16 character LCD display screen.

The Microreader contains all the filtering & noise blanking needed to allow reception even under bad conditions. A three colour bargraph tuning indicator makes precise tuning simple, while shift indicators take some of the guess work out of RTTY. Despite the fact the Microreader contains two fast processors (12MHz), it is extremely quiet generating virtually no RFI. The Micro-reader can also if you wish, transfer the decoded messages to any printer, computer or terminal unit equipped with an RS232 port.

In the tutor mode, the Microreader will send random groups of characters with variable speed & spacing, or plug in your own Morse key to check your sending. In both cases the characters are shown on the display.

The MKII Microreader comes complete with audio lead & demonstration tape. Full technical support & advice & upgrade service.

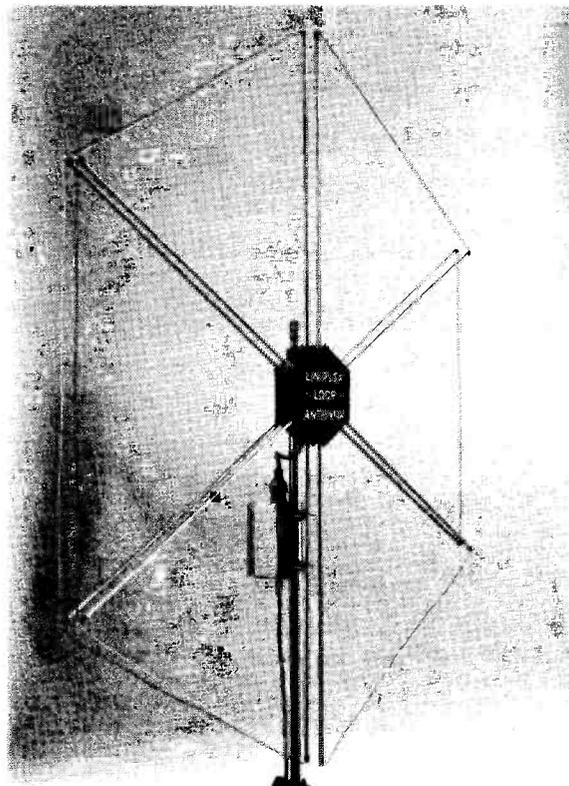

# LINIPLEX Loop Antenna

50kHz – 30MHz

- \* Only 1 metre wide
- \* Classic loop characteristics
- \* Figure of eight directivity
- \* Deep broadside nulls
- \* Effective at ground level
- \* Sensitive only to magnetic field
- \* Rejects power line interference
- \* Weatherproof and lightweight
- \* Current driven push-pull amplifier
- \* Patent pending

PHASE TRACK LTD., 16 Britten Road, Reading, RG2 0AU, England  
Tel: 0734 752666



## PC GOES

The PC GOES is a complete Weather Satellite program and demodulator system for the IBM PC™ family of computers.

- \* Processing of METEOSAT, GOES, NOAA and METEOR images.
- \* Supports Hercules, CGA, EGA, VGA with up to 256 colours or grey levels.
- \* Orbital Prediction and Realtime Plotting of tracks for up to 10 satellites.
- \* Automatic Image Capture Scheduler for date, time and frames.
- \* Storage and Retrieval of images from disk.
- \* Image Zoom, Pan, Reversal and False Colourisation.
- \* Slide Show Animation and Export to PCX files.
- \* Greyscale Printer output to all popular printers.

PRICE ONLY **£199.00** inc. VAT. P&P £2.75

## PC HF FAX

The PC HF Facsimile is a complete FAX reception system for the IBM PC™ family of computers.

- \* Display in grey scale or colour.
- \* Printer output in half tone.
- \* Supports Hercules, CGA, EGA, VGA.
- \* IOC rates 60, 90, 120, 180, 240 LPM
- \* Storage/Retrieval from disk
- \* Automatic Image Capture.
- \* Image Zoom, Pan, Reversal, Export.
- \* Slide Show Animation.
- \* Menu Driven Software.

PRICE ONLY **£99.00** inc. VAT. P&P £2.75

## PC SWL

The PC SWL is a complete package allowing reception of MORSE CODE, RTTY, and FEC.

- \* RTTY Baudot 45,50,57,75 and 100 Baud.
- \* RTTY ASCII 75,110,150 and 300 Baud
- \* CIR 476 Codes FEC, SELCAL and NAVTEX.
- \* MORSE CODE 1 to 40 WPM.
- \* Automatic Calibration and Code Recognition.
- \* Unattended Capture and Printing.

PRICE ONLY **£99.00** inc. VAT. P&P £2.75

To introduce our latest shortwave communication product we are offering a special package price.

Order PC HF FAX and PC SWL together for

**ONLY £178.00 INC VAT, P & P £2.75**

All units come complete with demodulator cable and comprehensive manual. They are simple to connect using no external power or expansion slots.

**CALL TODAY FOR FULL DETAILS.**

### COMAR ELECTRONICS

1A Birmingham Road,  
Cowes, Isle of Wight PO31 7BH  
Tel: 0983 200308

VISA



## AERIAL TECHNIQUES



### The Galaxy 25

- 10" Picture tube with 78° deflection and smoked screen filter.
- F10 Chassis with PAL/SECAM compatibility, together with 5.5, 6.0 and 6.5 MHz auto sound switching, enables this set to be used in FRANCE, UK and all of Western Europe.
- 12/24V or 240/220V operation from mains or battery.
- 39 Programme storage tuning.
- Full function remote control.
- Interactive 2 digit LED display.
- Built in Peritel socket allows this unit to be used with a variety of other AV equipment.
- Headphone socket for private listening.
- Extension speaker socket.
- Built in aerial.
- Covers Band 1, 3 & UHF plus all Cable channels.
- Features direct channel entry.
- Compact dimensions of:
  - Height: 25.5cm (10.03in)
  - Width: 26.5cm (10.43in)
  - Depth: 33.0cm (12.99in)
  - Weight: 10Kg

We supply aerial and receiving equipment for all types of domestic, TV-DXing, amateur and professional application. Our 29 page CATALOGUE at 75p is unrivalled in quantity, quality and sheer volume of content. Multi-standard TV's from 5" to 33" screen, also PAL/SECAM Multi-standard Video recorders are our speciality. UK and Overseas orders undertaken both retail and wholesale, ring or write with your query.

Available now from stock SECAM to PAL Transcoders, also Telecom 1C Signal Decoders for CANAL + and CANAL J (SAE for leaflet). RAI UNO & dual CANAL +/RAI UNO decoders now also available.

ACCESS & VISA Mail & Telephone orders welcome. Also American Express (24hr. service)

11, KENT ROAD, PARKSTONE, POOLE, DORSET BH12 2EH  
Tel: 0202 738232

## THE KITS WITH ALL THE BITS!

Guaranteed complete to the last nut!

### COMPACT 80m CW QRP Tx/Rx

- DTR3 Kit — £81.00 Ready Built — £130.00
- ★ Stable VFO ★ Sidetone ★ Audio Filter
- ★ Requires 12/14 VDC ★ Very detailed instructions ★ Black steel case ★ Printed panel

### ANTENNA TUNING UNITS

- TU1 Kit — £39.25 Ready Built — £54.50
- TU2 Kit — £48.50 Ready Built — £68.50

★ Large dia. coil ★ High grade capacitor ★ Built in balun ★ Circuits to match your antenna ★ Up to 30 Watts of CW ★ TU2 has sensitive QRP/SWR meter

Send SAE for brochure or call Alan G4DVW on 0602 382509

### LAKE ELECTRONICS

7 Middleton Close, Nuthall, Nottingham NG16 1BX

(callers by appointment only)

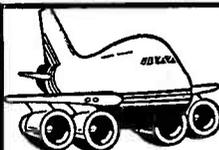
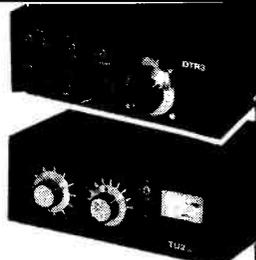

## FLIGHTDECK THE AIRBAND SHOP

192 Wilmslow Rd., Heald Green, Cheadle, Cheshire SK8 3BH  
Telephone: 061-499 9350 Fax: 061-499 9349

### ALL THE ENTHUSIAST NEEDS

RECEIVERS from Signal, Sony, Win, A.O.R., Icom, Uniden etc. MODELS from I.M.C., Airjet, Schabak etc. BOOKS from T.A.H.S., Ian Allan, Airlife, Osprey, Pooleys, etc. BINOCULARS/TELESCOPES from GreenKat, Kowa, etc. MAGAZINES from Air Britain, Aviation Letter, L.A.A.S., Scramble, Airliners, etc. PLUS Charts, Aerials for mobile and home base, Posters, Postcards, Prints... all this and much more..

Open: Monday to Saturday 9.30 a.m. - 5.30 p.m.

We are located on the A34 (Wilmslow Road), 2 miles South from the M63 Junction 10, just 3 miles from Manchester International Airport

Send 50p for illustrated Catalogue from Dept. SWM/3



# SEEN & HEARD

9.383MHz, FAX, 120, 576, -, 0800UTC, U.S. Navy Europe  
11.476MHz, RTTY, 50, 7, HMF52, 0800UTC, KCNA Pyongyang  
13.524MHz, RTTY, 50, 425, YIO72, 1512UTC, INA Baghdad  
13.56MHz, RTTY, 50, 425, -,

0825UTC, Ankara  
13.56MHz, c.w., -, -, BMB, 1830UTC, Taipei Meteo, fast c.w.  
13.563MHz, RTTY, 50, 425, 3MA22, 1500UTC, CNA Taipei News  
14.565MHz, RTTY, 50, 425, RUE57, 1004UTC, UNID

14.737MHz, FAX, 120, 288, RX072, 1238UTC, Khab Meteo  
15.016MHz, RTTY, 100, 425, -, 1412UTC, MFA Cairo English news  
16.410MHz, FAX, 120, 576, NAM, 1030UTC, U.S. Navy Norfolk VA  
18.055MHz, RTTY, 75, 425, DFZG,

1449UTC, MFA Belgrade News  
18.710MHz, FAX, 120, 576, RIZ59, 0910UTC, Moscow Meteo

**If you would like a copy of Mike's current frequency list, then send him 3 first or second class stamps with your name and address**

## INFO IN ORBIT

Lawrence Harris

5 Burnham Park Road, Peverell, Plymouth, Devon PL3 5QB

We are seeing a period of intense activity with the weather satellites such as I haven't known before! September has seen the successful operation of the new Chinese satellite FENGYUN 1(2), COSMOS 1602 has come back on, the METEOR group change again and OKEAN transmits daily pictures. Add to that several letters and more on the METEORS and I have a problem to squeeze it all in to the allocated space!

### New Chinese WXSAT

On September 3 I picked up the new Chinese weather satellite FENGYUN 1(2). The surprise was its transmission frequency - 137.80MHz. The first satellite in this series was FENGYUN 1(1) which transmitted on 137.035MHz, but we now know that the Chinese plan to use two frequencies, rather like the NOAAs use 137.62 and 137.50MHz.

FENGYUN was on a northbound pass when I first picked it up. This was apparent from the almost blank pictures which had twilight brightening along the left side of the picture as the craft approached the north pole so its direction could be identified. I recorded the data and have taken some photographs for later publication in this column.

The picture format from FENGYUN 1(2) can be heard and currently consists of two visible pictures side by side. No doubt this will change over to visible and infrared in due course.

The next day saw the first daytime pictures from the satellite as it travelled southbound over the UK. As expected, the times of each pass were seen to be almost identical from day to day. The satellite covers virtually 14 orbits per day, fixed by careful adjustment of its orbital height. The ground track passes over the same area each day and at about the same time.

The name FENGYUN 1(2) means that it is in the FENGYUN 1 series of polar orbiting satellites being number 2 in that series. The FENGYUN 2 series has been announced and will operate from geostationary orbit. All will include high resolution pictures.

### Kepler Elements

These are the very latest available at press-time:  
Fengyun 1(2)

**Epoch:** 1990 254.87198272  
**Decay:** 0.00000356  
**Inclination:** 98.9358  
**RAAN:** 289.3805  
**Eccentricity:** 0.0010120  
**Arg P:** 243.8355  
**Mean anomaly:** 116.1772  
**Mean motion:** 14.00444815

**Rev:** 124

UK pass times for October 27

FENGYUN 1(2); AOS=Acquisition of signal (UTC), LOS=Loss of signal, Maxel=Maximum elevation of satellite and in what direction (e.g. 5° east) and whether north (NB) or southbound (SB).

AOS	LOS	Maxel	Direction
0617	0627	5 E	SB
0757	0813	41 E	SB
0939	0955	39 W	SB
1122	1133	9 W	SB
1617	1626	5 E	NB
1754	1809	24 E	NB
1934	1951	72 W	NB
2119	2132	13 W	NB

These times will advance by a minute or so each day.

### COSMOS 1602

On the morning of September 1 I picked up transmissions from what I first took to be an unscheduled OKEAN-3 launch. The data was received apparently on 137.30MHz at 0912UTC. I attempted to record the telemetry but everything went wrong including the recorder being out of tape and then other problems beset me. Finally I switched it on and then we had LOS - it was a low pass!

Afterwards I updated my computer with Kepler elements for the older satellites. The predictions for COSMOS 1602 fitted perfectly and gave the next pass as 2009UTC. The transmission came in on time and was recorded. It was transmitting an apparently blank picture, including the number sequence with the counter incrementing each minute.

During early September I did not hear COSMOS 1602 again but on September 6 there it was at 2025UTC but careful tuning revealed that it was really on 137.28MHz. It has remained transmitting on every pass but of course it may be switched off by the time you read this. COSMOS 1602 was one of the oceanographic satellites that was in use before OKEAN became operational.

### Frequencies

We have seen so many changes within the Russian weather satellite system that I have extended the listing slightly to remind new readers of the common frequencies.

**NOAAs 9 and 11** (American) use 137.62MHz for a.p.t. (picture) data and beacons on 137.77MHz  
**NOAA 10** uses 137.50MHz for a.p.t. and has a beacon on 136.77MHz  
**FENGYUN 1(2)** (Chinese) uses 137.795MHz (it may use 137.035MHz)  
**OKEAN 2** (Russian) uses 137.40MHz  
**COSMOS 1602** is on 137.28MHz  
**METEOR 2/18** uses 137.30MHz  
**METEOR 3/2** uses 137.85MHz

Any **METEOR** may use 137.30, 137.40 or 137.85MHz

### Letters

Another good postbag this month plus some phone calls for information. **Tom Higginbottom G3LCZ** was pleased to spot this column because he has recently become interested in monitoring weather satellites using a Maplin receiver and decoder feeding his BBC Master 128 computer. He also operates the Cirket receiver as well. Tom requested data tapes to check out his system.

Another user of RX-8 software is **Noel Richins G3VKR** of Derby who also uses the APT-1 unit for weather satellite work, with a BBC B computer. He has built his own receiver and tells me that he is a 'born again' amateur who has had his interest rekindled. He requested a data tape for equipment testing because he was concerned about resolution. In fact the BBC computer will limit the resolution because it has a rather small memory for this work. I appreciate the letters often sent after a tape has been despatched and the one from Noel told me that his tape had worked well and proved that his system was OK.

The Spectrum computer has many users and **Mr N Darnbrough** of West Yorks wants to locate some satellite tracking software for his. I am keeping records of all software and computers that I come across but I don't know of any source so perhaps a reader can help?

I met **David Newell** of Liskeard at the recent Plymouth Radio Rally meeting when we were both looking at the Spaceteck Archimedes software. David bought it and wrote to me asking for the latest Kepler elements.

Another reader using the Maplin decoder is **Mr N Grundy** of Bar Farm, 15 Main Road, Drax, Selby, N Yorks whose full address I have given because he is offering to supply details of his home-written software which runs on the Amiga computer and predicts satellite passes and much more. If you would like to receive more details please send Mr Grundy an s.a.e.

Kepler elements were also despatched to **Bill Turner G4LML** of Coventry who is particularly interested in the more unusual 'birds' like UK6 and ARYABHATA which can be heard in the 136MHz band. If space permitted I would like to include such elements sets in the column. UK6 can still be heard on 137.56MHz about five passes per day but is near to re-entry. Bill has the YU3UMV framestore, a Cirket receiver and various home-made antennas.

**Sean Franklin** of Mitcham wrote to request a cassette recording of NOAA and METEOSAT to test his equipment though he doesn't mention what that is. All tapes were despatched within a few days.

### Pictures

My wife Marion says that I should always include a picture to show what it's all about, so I have taken a far westerly pass from NOAA 11 showing Newfoundland. I am getting some excellent results from my new system, Timestep's VGASAT which uses the high quality VGA monitor to produce perfect pictures. It allows the complete satellite resolution to be seen in 64 grey levels or full colour and is spectacular.

The facility that took my breath away was the ability to read in recorded METEOR data without any reference track and play it back perfectly synchronised! This lets me

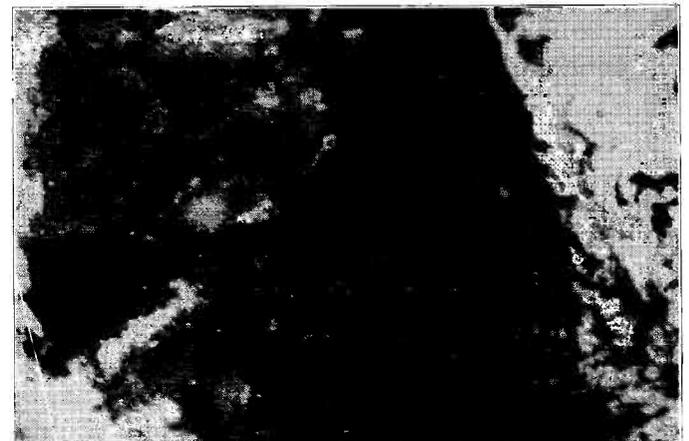

NOAA 11, 16 May 1989 1545UTC Newfoundland

# SEEN & HEARD

record the METEORS during the day and allowed me to spot a change from METEOR 3/3 back to 3/2 this evening.

The software has contrast stretching options which allowed me to identify the UK although it was almost invisible. The NOAA software has programmable delays and allowed me to record imagery overnight quite automatically.

Dave Cawley (of Timestep) invited me to send him an OKEAN recording and he used it to write his new software which has produced superb detail from my numerous recorded radar pictures. More on this when space allows!

The METEOSAT animation software works perfectly and has not failed. Again the image quality is the best that can be obtained and am must confess to having difficulty leaving it alone! I must also mention that I have read reviews elsewhere which do not appear to be accurate!

## The USSR METEORS

**The METEOR 3 series:** Previous mention has been made of the METEOR 1 series of experimental weather satellites which ended when METEOR 1/30 was finally switched off. The METEOR 2 series continues now though currently only 2/18 is in operational use.

The METEOR 3 series is now operational though regular monitors of the transmissions will know that

there have been long periods without any series 3 satellites transmitting data. This series uses improved equipment compared with that on the previous series as a glance at the list shows.

The tests began in October 1985 with the launch of MET 3/1 and the orbital height was increased to some 1200 to 1250km while using the same inclination of 81 to 83°. These higher altitudes enable larger swathwidths for the onboard TV systems and yet resolution has been increased. It is planned to have two or three operational satellites in this system though it is not clear whether this means backups or simultaneous transmissions. This will ensure that global TV images of the sunlit earth and radiation data are available at least twice per day. Also required are global infra-red images of the sunlit earth at least four times daily. This means that we may see a change in the transmission format to something similar to the NOAA satellites which transmit simultaneous visible and infra-red images.

Data from this series of transmissions is used not only for weather forecasting but also for monitoring hurricanes, the selection of routes for ocean-bound ships and to assess the thickness of ice on seas, lakes and reservoirs.

The equipment carried by this series of satellites includes the following:

1. Scanning TV with an on-board

recorder to allow global data to be collected. This uses the 0.5 to 0.8µm band with a swathwidth of 3100km and a resolution of 0.7 by 1.4km available for both direct transmission and recording. So METEOR 3 images cover more ground and at a higher resolution than the METEOR 2 series.

2. Scanning TV system for transmission to simplified receiving stations. This uses the same 0.5 to 0.8µm band as before but with reduced swathwidth of 2600km and resolution of 1 by 2km. This system is used in direct transmission mode.

3. A global observation infra-red radiometer to transmit data to the simplified ground stations using the 10 to 12.5µm band, having a swathwidth of 3100km and a resolution of 3 by 3km and which can be used for either recording or direct transmission.

4. A ten-channel scanning infra-red radiometer using the 9.65 to 18.7µm band which can be used in either mode.

5. A radiation measuring unit measuring flux in the 0.17 to 600MeV range which can also be used for either direct or recorded data.

## High Resolution Data

The METEOR satellites, like their NOAA equivalents, are able to transmit high resolution data and do so when commanded when they are over the USSR. The frequency used is about 240MHz.

## Remote Imaging Group

Several SWM readers have written to me about the long time between the appearance of the RIG magazines. Membership secretary Des Watson has suggested to me that RIG members can ring the committee directly with their queries using the numbers given in the club magazine. All the work is done by volunteers.

## British Amateur Radio Astronomy Society

A similar problem has occurred with BARAS with its club magazine *Gamma*. Steven Newberry sends his apologies to the membership and is proposing that the membership fee will be extended to include 1991 as well.

It is worth remembering that our radio equipment can be used to investigate the universe as well. I have added a down-converter to a 150MHz antenna in order to turn my h.f. receiver into a radio telescope.

For the latest updates on the satellite world, ring Radioline on 0898 654676.

calls charged at 33p per minute cheap rate, 44p per minute all other times

## BAND II DX

Ron Ham

Faraday, Greyfriars, Storrington, West Sussex RH20 4HE

For your weather records, **Robin Clark** (Wembury) tells me that of the 3in of rain that he recorded for the whole of July, 2in of it fell on the 27th. On that day, Princetown (Dartmoor) had 3in. Robin has kept weather records for the past four years and reports that on August 3, Plymouth recorded their highest temperature of 32°C for the year. As you will see from Fig. 1, my garden thermometer nudged 38°C (100°F) on that day. "Shade temperature 100°F!" wrote **Patrick Moore** from his home in Selsey, Sussex, on August 3.

Whilst Joan and I were in nearby Bosham on the 9th the temperature was around 22°C, with a light westerly wind and, as the notice board in the harbour (Fig. 2) said, there were "Dry Long Sunny Periods", with a "Similar" outlook. The clouds were, in fact, a front coming in. By 0300 on the 10th the pressure was falling from 30.3in (1026mb) and continued to do so until it reached 30.0in (1015mb) around 0600 on the 12th.

As expected, a tropospheric opening occurred and Robin Clark received stations from France,

Germany (BFBS) and Scandinavia, some in good stereo, between 1930 and 2100 on August 11. He counted 18 foreign voices between 89 and 107MHz during the evening of the 12th. Incidentally, just over one inch of rain from the 1.42in that I recorded in August fell between the 14th and 19th with Hygrometer readings of 84% at 1300 on the 15th and 85% at 2100 on the 19th and hail and thunder at midday on the 16th.

The pressure hovered between 30.4in (1029mb) and 30.3in from midnight on September 10 to noon

on the 14th and with it came a mild opening. I first noticed this when I heard a Dutch station around 101MHz on my Plustron TVR5D, with its own rod antenna, while parked near Barcombe, Sussex, at 1700 on the 12th. Next morning, from home, using the R216 and chimney dipole, I heard several French, Dutch and German stations, plus many co-channel 'warbles' scattered through the band. At 1645, I was parked near Goodwood, Sussex, and logged a strong French station around 100MHz.

While on holiday, early in

Multi-Mode



PRICE INCLUDES FREE IBM-PC, CBM-64 DATA AND FAX SOFTWARE ON DISK

## PK-232 MBX Multi-Mode Terminal Unit

With over 40,000 units shipped, the PK-232 is the world's leading multi-mode data controller. The PK-232 MBX combines Morse Code, Baudot, ASCII, AMTOR/SITOR, HF and VHF packet, WEFAX transceive and NAVTEX receive in one comprehensive unit.

- Exclusive SIAM™ Signal Identification and Acquisition mode

- 20 front panel status indicators
- TDM Time Division Multiplex
- PakMail™ mailbox with 3rd party traffic
- FAX printing - supports most printers
- Two radio ports
- Host Mode program control
- KISS mode for TCP/IP
- 32K Lithium backed RAM

PK-232 MBX: £299.95 inc. VAT (£5.00 post and packing)



ICS Electronics Ltd. Unit V, Rudford Industrial Estate, Ford, Arundel, West Sussex BN18 0BD

Telephone: 0903 731101 Facsimile: 0903 731105

VISA

## GUIDE TO FACSIMILE STATIONS 1990

10th Edition - June 1990 400 Pages - GBP 19.- or DM 50. -

The FAX mode gets more and more fascinating. The recording of FAX stations on LW and SW and the direct reception of meteo satellites is no longer an esoteric science. New hard- and software connects a radio receiver directly to a laser printer. The result is press photos, satellite pictures and weather charts with the superior resolution of more than 2000 picture elements per scan line.

The new edition of our FAX GUIDE contains not only the usual up-to-date frequency lists and transmission schedules, including those of Bracknell Meteo and Royal Navy London. It informs you particularly about new FAX converters and programs on the market, and includes the most comprehensive international survey of the "products" of weather satellites and FAX stations from all over the world. More than 300 sample charts and pictures were recorded in 1989 and 1990. Here are that special charts for aeronautical and maritime navigation, the agriculture and the military, barographic soundings, climatological analyses, and long-term forecasts which are available nowhere else. Additional chapters cover:

- List of 389 frequencies - from VLF to UHF - monitored in 1989 and 1990.
- Exact schedules of 98 FAX stations on 357 frequencies.
- Comprehensive list of geostationary and polar-orbiting meteo satellites. Schedules of GMS (Japan), GOES-East and - West (USA), and METEOSAT (Europe).
- Technique of FAX transmission. International regulations.
- Lists of abbreviations, addresses, and call signs. Test charts.

Further publications available are GUIDE TO UTILITY STATIONS (16th edition) as well as RADIOTELETYPE CODE MANUAL and AIR AND METEO CODE MANUAL (10th/11th editions). We have published our international radio books for 20 years. They are in daily use at equipment manufacturers, monitoring services, radio amateurs, shortwave listeners and telecommunication administrations worldwide. Please ask for our free catalogue, including recommendations from all over the world. All manuals are published in the handy 17 x 24cm format, and of course written in English.

Do you want to get the TOTAL INFORMATION immediately? For the special price of £ 87/DM 230 (you save £15/DM 40) you will receive all our manuals and supplements (altogether more than 1500 pages!) plus our CASSETTE TAPE RECORDING OF MODULATION TYPES.

Our prices include airmail postage to everywhere in the world. Payment can be by cheque, cash, International Money Order, or post giro (account Stuttgart 2093 75-709). Dealer inquiries welcome - discount rates and pro forma invoices on request. Please mail your order to:

**Klingenfuss Publications**  
Hagenloher Str. 14, D-7400 Tuebingen,  
Fed. Rep. of Germany Tel: ++49 7071 62830

## HOLDINGS AMATEUR ELECTRONICS

G3LLL for ICOM & YAesu  
CW filters FT101ZD, FT902, FT707, FT102 £40 P.P. - Valves & Mod kits  
FT101MK1-E, PX commission sales.  
45 JOHNSTON STREET, BLACKBURN BB2 1EF  
5 Miles from Junc. 31, M6 Tel: (0254) 59595  
BUT HOLS? PHONE FIRST.

## REALISTIC PRO-2004 OWNERS

**MOD 1** All you need is a few minutes and a soldering iron to upgrade your scanner to \*400 CHANNELS & SUPER FAST SCAN\*  
**MOD 2** By demand - A further selection of simple low-cost modification ideas for the 2004 includes - 'Tune-up' 'S-meter' 'Turbo-Scan' & more.

★ Each kit only £5.00 incl. P&P, or SAE for details ★  
P. Beckett 3 Pasture Close, Whitmore, Staffs ST5 5DQ

## FOR ALL YOU BUDDING SCANNING ENTHUSIASTS!

*A very special message.*

- We have just published our very latest CATALOGUE containing some very exclusive frequency listings. Everthing from 25MHz to 2000MHz is contained within in this catalogue.
- Send today for this very special catalogue which is both reliable and a lot cheaper than any possible competition. Also included with all orders, a superb FREE info pack which includes among other items reviews and tests on the latest scanner imports.
- All orders dispatched by return post. To order our catalogue write to:

## RADIO DATA SYSTEMS

P.O. Box No. 1135, St Osyth, Clacton on Sea, Essex CO16 8PY  
Enclosing an A4 SAE.

# C.M. HOWES COMMUNICATIONS

## ADD SHORTWAVE TO YOUR SCANNER!

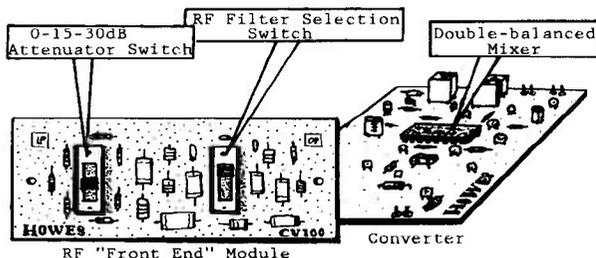

## NEW! HOWES CV100

The new **HOWES CV100** converts medium and short wave signals to VHF so that they can be tuned with a normal scanning receiver. The CV100 adds 100MHz to the incoming frequency. For example, to listen to amateurs on 29.6MHz FM, simply tune your scanner to 129.6MHz and select NBFM. With the CV100 connected between your receiver and a suitable antenna, you will now receive any signal appearing on the 29.6MHz FM calling channel. With good propagation conditions, the signals you hear can come from almost anywhere in the World! To listen to an AM broadcast on 7.150MHz, simply tune your scanner to 107.150MHz and select AM mode, the CV 100 has added 100MHz to the incoming frequency. There are no modifications to the receiver, the CV100 simply connects between its antenna socket and a suitable antenna (HOWES AA2 etc). All the receiver's normal functions are retained. A switched RF attenuator and RF filter selection are the only operational controls on the CV100.

- ★ Input frequency range 1 to 40MHz.
- ★ Output frequency range 101 to 140MHz.
- ★ Crystal controlled converter with SL6440 mixer.
- ★ RF input filters and switched attenuator.
- ★ Requires 12 to 14V DC supply.
- ★ Easy to build kit, or ready built modules.

If you would like to upgrade the frequency coverage of your scanner, then the HOWES CV100 could be the ideal way of adding extra bands without the cost of buying an additional receiver. Performance is excellent.

CV100 Kit: £25.90

Assembled modules: £35.90

Mail order to: EYDON, DAVENTRY  
NORTHANTS NN11 6PT  
Tel: 0327 60178



### AA4 ACTIVE ANTENNA for SCANNERS!

The **HOWES AA4** Active antenna gives full coverage from 25 to 1300MHz. It is designed to be the ideal solution for those requiring a compact, broadband antenna for use with scanning receivers. The AA4 features advanced technology with a low noise microwave IC as the active element.

- ★ Fully broad-band covering 25 to 1300MHz
- ★ Low noise microwave IC (NF <3dB). Over 15dB gain.
- ★ Third order intercept +15dB at 500MHz
- ★ Coax powering 12 to 14V DC at less than 20mA.
- ★ 10dB switched attenuator on the receiver interface board.
- ★ Antenna elements ready formed on printed circuits for easy construction. Size approx 16 inches long, 1.2 inches wide.
- ★ Easy to build kit, or ready built modules.

If your scanner reception could benefit from the addition of a remotely located broad-band antenna with built in pre-amplifier or you would like a much neater, more compact alternative to the large, ugly disc type, then the HOWES AA4 could be just the job! Excellent performance in a small space!  
AA4 kit: £18.80 Assembled PCB modules: £24.90

### AA2 ACTIVE ANTENNA for 150kHz to 30MHz

The **HOWES AA2** is the active antenna to use with a general coverage HF receiver. Broad-band performance that does not tail off at the higher frequencies. The neat compact answer for those with limited space, holiday use, mobile operation etc. Two selectable gain settings, local or coax powering (12 to 14V), easy to build, and much liked by customers!  
AA2 kit: £7.50 Assembled PCB module: £11.50

PLEASE ADD £1.00 P&P to your total order value.

### THE NOVICE LICENCE IS COMING!

A new cheaper, simpler way to get "on the air" on the amateur bands! We have been supplying novice type equipment for nearly eight years, so there is a good selection of suitable kits in our range. You could start building your station now! Please send an SAE for the free catalogue! Sales and technical advice are available by phone during office hours - you can actually speak to people who know what they are talking about!  
All **HOWES KITS** contain a good quality printed circuit board with screen printed parts locations, full instructions and all board mounted components. Our kits offer the challenge and satisfaction of home construction, with the reassurance of help if you need it.

73 from Dave G4KQH, Technical Manager

Many Radio Amateurs and SWLs are puzzled.

## JUST WHAT ARE ALL THOSE STRANGE SIGNALS YOU CAN HEAR BUT NOT IDENTIFY ON THE L.F. AND H.F. FREQUENCIES?

A few of them, such as CW, RTTY, and Packet you'll know - but what about the many other signals?

**Hoka Electronics** have the answer! There are some well known CW/RTTY decoders with limited facilities and high prices, complete with expensive PROMS for upgrading, etc., but then there is **CODE 3** from Hoka Electronics! It's up to you to make your choice - but it will be easy once you know more about **CODE 3**! **CODE 3** works on any IBM-compatible computer with MS-DOS having at least 640Kb of RAM. **CODE 3** hardware includes a complete digital FSK Converter with built-in 230V a.c. power supply and RS232 cable, ready to use. You'll also get the best software ever made to decode all kinds of data transmissions. **CODE 3** is the most sophisticated decoder available, the best news of all is that it only costs **£249 plus VAT!** The following modes are included in the base-program (with the exact protocols).

- |   |  |                                   |
|---|--|-----------------------------------|
| ★ Packet Radio AX25, 50 to 1200 Baud  | ★ Autospec Bauer: ITA 2 including 3 modes Spread 11, 21 and 51 | ★ ARQ-S: ARQ 1000S                |
| ★ Hell: Synchronous/asynchronous, all speeds  | ★ SITOR A and B automatic                                      | ★ ARQ-Swe: CCIR 518 variant       |
| ★ Fax: Weather charts, photographs with up to 16 grey scales at 60, 90, 120, 180, 240 rpm | ★ Pol-ARQ  | ★ ARQ-E: ARQ 1000, IRA 2-p Duplex |
| ★ Morse: Automatic and Manual with speed indication                                       | ★ Duplex ARQ Artrac ITA 2                                      | ★ ARQ-N: ITA 2 Duplex             |
| ★ Press DPA: F7b spec., 300Baud ASCII   | ★ TWINPLEX F7b-1 upto F7b-6 Duplex ARQ                         | ★ ARQ-E3: CCIR 519 ITA 3          |
| ★ Wirtschaftsdienst: F7b spec., 300 Baud ASCII  | ★ ASCII  | ★ ARQ-6: 5/6 character 90 and 98  |
| ★ Sport Information: F7b spec., 300 Baud ASCII  | ★ Baudot: ITA 2 plus all types of Bit inversion, at any speed  | ★ TDM 242: CCIR 242 2/4 channels  |
| ★ FEC-A: FEC 100(A) ITA 2-P FEC Broadcast   | ★ ARQ: CCIR 476, CC1R 625 mode A                               | ★ TDM 342: CCIR 342 2/4 channels  |
|   | ★ FEC: Sel-FEC CCIR 625 476-4 mode B Sitor Amtor               | ★ FEC-S: FEC 100S ITA 3           |

All modes in preset and variable user-defined speedrates and shifts. Three options are available to use with the **CODE 3** and consist of:

- 1: **OSCILLOSCOPE**, this facility displays the measured frequency versus time, including split-screen, storage and non-storage modes at £25.
- 2: **PICCOLO MK VI** (Everybody wants this facility, but it's only on offer from Hoka!), the well-known multitone-mode at £60.
- 3: **LONG-TIME AUTO-STORAGE** in ASCII (up to several days) £25.

Plus many other special codes. Send for details, price on application.

ALL PRICES IN BRITISH POUNDS.

Along with the many facilities listed, the analysis section of the **CODE 3** offers you a wide choice of unique facilities such as: a built-in **low frequency spectrum analyser** for shift measurement and tuning, plus precision speed measurement up to 0.001 Baud resolution. Other tool-facilities include Speed Bit analysis, Speed Measurement, Character Analysis, Auto-correlation of MOD and RAW signal, bit Analysis. All these state-of-the-art features are included in **CODE 3** to assist the experienced user. All options are available from the main menu, saving or loading to or from hard or floppy disk in bit form (no loss of unknown signals), hard copy with printer, on-screen tuning indicator and very easy to use Help-files.

To order, 'phone us for more details or send cheque, payable to:

### HOKA Electronics,

Feiko Clockstraat 31, NL-9665 BB Oude Pekela, The Netherlands

Tel: 010-31-5978-12327 Fax: 010-31-5978-12645

Please specify disk size 3.5" or 5.25" when ordering! All prices are exclusive of VAT but include six months software up-dating free!

### HOKA UK

84 Church Street, Langford,  
Biggleswade, Beds SG18 9QA.  
Tel: (0462) 700644

## Tidy up that pile of mags!

0202 665524



### SWM BINDERS Only £4.50 each

(plus £1 p&p for one binder, £2 p&p for two or more, UK or overseas)

Are you tired of sifting through cardboard boxes and carrier bags to find that useful item in SWM?

Our smart binders, covered in blue plastics, are a must for your library, keeping your radio magazines in good condition and easily accessible.

### Plus!

Tidy up those other mags too. Plain binders to take any A4 size magazines - no names, no pack drill !!!

### HOW TO ORDER

Send a postal order, cheque or international money order with your order stating number and type required to **PW Publishing Limited, FREEPOST, Enefco House, The Quay, Poole, Dorset BH15 1PP.**

Payment by Access, Mastercard, Eurocard or Visa also accepted on telephone orders to Poole (0202) 665524. Normally despatched by return of post but please allow 28 days for delivery.

Prices include VAT where appropriate.



# SEEN & HEARD

September, **David Glenday** (Arbroath) was amazed to find strong signals from Radio Borders at his location, sheltered by hills, about 2.5km from Barchory. He could also hear North Sound but nothing from Radio Tay except when conditions are good.

## Sporadic-E

**Barry Bowman** (Prestwich) heard programmes in Arabic and German co-channeling around 87.5MHz on August 1, an Italian station, "probably Radio Uno" with pop music on 87.6MHz on the 16th and Catalunya Radio on 100.7MHz and possibly Cadena 13 on 87.7MHz from Spain at 1825 on the 23rd. During a minor Sporadic-E opening around 2030 on August 23, I found 9 East European f.m. stations between 66 and 70MHz and 40 more at 0750 on September 2. While this latter and more intense event was in progress, I also received television pictures from the same area on Chs. R3 (77.25MHz) and R4 (85.25MHz) plus their sound signals on 83.75 and 91.75MHz respectively.

## Info

My reference to the WWII clandestine broadcast station, code-named Aspidistra, in our September issue prompted **David Scott** (Montrose) to confirm that one of the books about it is called *The Black Boomerang*, written by Sefton Delmar. David also showed me a booklet, published by

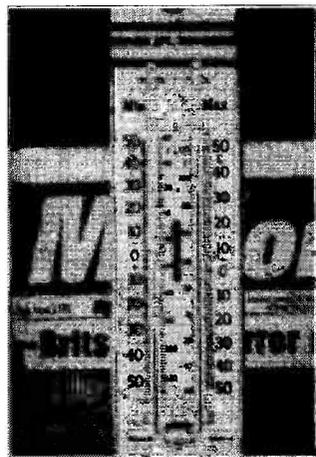

Fig. 1: My thermometer - dated by the newspaper.

the BBC in 1955, listing the ten v.h.f. f.m. stations that had been approved by the Government. These were at Blaen Plwy, Divis, Holme Moss, Meldrum, North Hessary Tor, Norwich, Pontop Pike, Sutton Coldfield, Wenvoe and Wrotham and estimated to provide 83% of the population with the 'Light', 'Third' and 'Home' programmes on selected frequencies between 88 and 95MHz.

In addition to a Tandy PRO-34 scanner, David has a Sony WA8000 which he uses to record signals from his Sony ICF-7600DS and ICF-SW1E

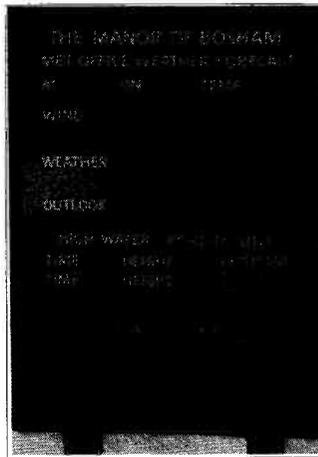

Fig. 2: The harbour weather forecast.

receivers. The former is fed by a 40m long, random wire, antenna and the latter has an AN1 active antenna. Although Montrose is not within the official service area of any local radio v.h.f. transmitter Radio Tay from Tay Bridge on 102.8MHz is received with an acceptable stereo signal. However, David also gets acceptable signals, generally best in mono, from North Sound Radio (Granite Hill, Aberdeen) on 96.9MHz and Radio's Borders (Selkirk and Eyemouth) on 96.8 and 103.4MHz respectively and Forth (Craigkeily) on 97.3MHz.

## TELEVISION

Ron Ham

Faraday, Greyfriars, Storrington, West Sussex RH20 4HE

When I heard from **Simon Hamer** (New Radnor) that he had received distorted pictures on Chs. E2 (48.25MHz), R1 (49.75MHz) and from Ireland (RTE) on their Ch.B (53.75MHz), via the aurora, on August 22, I thought you would like to see the size of the sunspot group, Fig. 1, which almost certainly produced the radiations that caused the aurora to manifest. This observation of the sun was made and drawn by **Patrick Moore** (Selsey) at midday on the 23rd, via the projection apparatus in his Sussex observatory. I have introduced sunspots at this stage because their activity during the coming winter months, could disturb the 'F2' region of the ionosphere and consequently open up Band I to the middle and Far East for short periods.

## Band I

As the 1990 Sporadic-E season ends, I must congratulate **Russ Burke** (Northampton) on receiving a test-card from Gibraltar at 2345 on August 2 (Fig. 2) and an unidentified caption 'GB airways time to fly' to the left of a clock (Fig. 3) (possibly Gibraltar again) at 0040 on the 10th. He also logged another clock caption (Fig. 4) with the word *Sorteos* and wonders if anyone can identify its source. "Please excuse the quality of the pics but as you may well imagine I dare not waste time messing about setting up the camera. Hence the black bars," wrote Ross and I agree with him. The most

important thing is to get the record, DXers know only too well that such pictures often appear suddenly and may only remain clear for a matter of minutes.

During Sporadic-E openings on August 12 and 13, **Ern Warwick** (Plymouth) reports hearing a CB operator in Scotland say that he was receiving TV pictures from Germany, Italy and Scandinavia and a CB enthusiast in Plymouth reported spasmodic TV signals from Belgium and Germany at 1817 on the 16th.

I observed weak to reasonable pictures, most likely from Spain, on Chs. E2 and E4 (62.25MHz) between 2000 and 2100 on August 23. **Barry Bowman** (Prestwich) found conditions in August variable, "ranging from poor to very good". He logged pictures from Italy (RAI UNO) on days 1, 2, 4, 6, 9, 11, 16 and 23, Norway (NRK) on the 4th, Spain (TVE1&2) on days 2, 4, 5, 11, 16 and 23, Sweden (SVT) on the 2nd and 4th and Yugoslavia (TV NOVI SAD and JRT) on the 1st, 6th and 9th. In addition to adverts, films, music, news, etc, he saw such captions as, 'Telegiornale and Giochi Senza Frontieri from Italy, the regionals Bagn and Greipstad from Norway, Esta Noche, Houston Nights, Informa, Jueves 2245HR, Loteria, Sins, Telediario and TV Aragon from Spain, SVT Kanal 1 Sverige from Sweden and ALF, TVNS and TV Slovenia from Yugoslavia.

Barry also watched a programme

about the Queen Mother, on Ch. R1, from an unidentified station on the 5th and heard unidentifiable sound on Chs. E2 or E2A (49.75MHz) on the 16th and Chs. E2 or R1 and later on Ch. E3 on the 23rd.

**Bob Brooks** (Great Sutton) saw adverts, teletext and a test-card from Switzerland (PTT-SRG1), a clock logo from Germany (ZDF), a Laurel and Hardy film from Italy (RAI) and test-cards from Bratislava, Poland (TVP) and Yugoslavia (RTV Ljubjana) on August 10, programmes from RAI and/or TVE on the 11th, 16th, 18th, 23rd and 31st, Germany's ARD SWF clock logo on September 1 and test-cards from the Norwegian regionals Hemnes and Steigen and Sweden (SVT KANAL 1) on the 3rd.

Among the captions seen by **David Glenday** (Arbroath) during August were CST from

My thanks to **Jason Faulkner** (Leicestershire) for telling us that a firm called Alfasound are retailing a dozen different cassettes of Radio and TV station ident jingles at £7.99 each including VAT and p&p. Readers interested should address their enquiries to Alfasound (Telesales Dept.), St Martin's Studios, Greenbank Road, Ashton-upon-Mersey, Sale, Cheshire. M33 5PN.

Jason has spent untold hours of research and sorting time to make himself a most useful station by station guide from 86.6 to 105MHz showing about 200 stations, including their transmitter locations and antenna polarity, operated by the BBC, IBA and Community services. He gained most of the information from teletext and from the publications *BBC Transmitting Stations-Spring '90* and *IBA Transmitting Stations*. These are available by sending a medium sized s.a.e. to BBC Engineering Information, Room 711, Henry Wood House, Broadcasting House, London W1A 1AA and to Crawley Court, Winchester, Hampshire SO21 2QA, for details about the IBA's network. Engineering information is also available from the BBC on CEEFAX page 698, IBA on ORACLE page 297 and IBA Ch4 on ORACLE page 697. I learnt from CEEFAX on September 19, that the BBC have new stations due in December carrying Radios 1, 2, 3 and 4 for Chalford and Nailsworth in Gloucestershire, Weymouth in Dorset and Grantham in Lincolnshire.

Czechoslovakia and BPEMR (news) and Olivetti around the clock from the USSR (TSS) on the 9th, the regionals Hadsel and Steigen from Norway on the 23rd, Nachrichten from Switzerland and Cisto Pravi Gusar, possibly from Yugoslavia, on the 28th. He also identified pictures from Italy (RAI), Portugal (RTP) and Spain (TVE1) on the 11th.

In Basingstoke, **John Woodcock** received pictures from Italy on August 27 and reports that he heard an American amateur saying that it had been a poor Sporadic-E season so far over there. This adds a bit more weight John to the general view that the 1990 Sporadic-E season has been patchy and disappointing for long distant TV.

Simon Hamer received various programmes, test-cards and idents from stations in Albania (RTSH), Austria (ORF), Czechoslovakia (CST), Poland (TVP), Portugal (RTP), Spain (RTVE1 and 2), Switzerland (+PTT SRG1) and Yugoslavia (JRT) on August 9, Denmark (DR), Iceland (RUV), Norway, Poland and Sweden on the 21st, Albania, Austria, Czechoslovakia, Hungary (MTV), Italy, Portugal, Spain, Switzerland, the USSR and an unidentified Arab station, on Ch. E3 (55.25MHz), on the 24th, Italy and Poland on the 31st, Iceland, Norway and Yugoslavia on September 1 and Hungary and the USSR on the 2nd.

At 0730 on September 1, I received fading pictures and a background

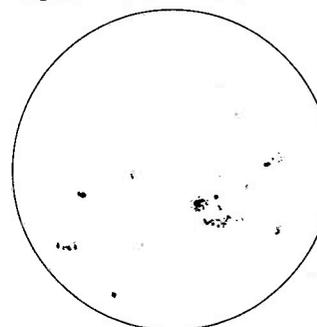

Fig. 1: Sunspots on August 23.

# SEEN & HEARD

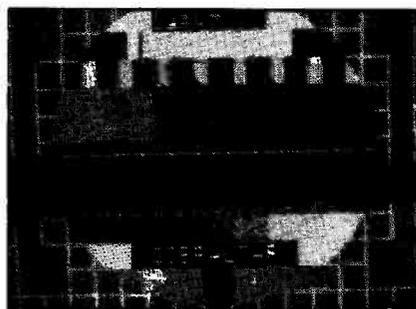

Fig. 2: Gibraltar.



Fig. 3: Gibraltar?



Fig. 4: ?

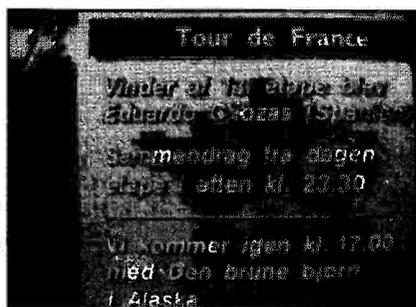

Fig. 5: Denmark.

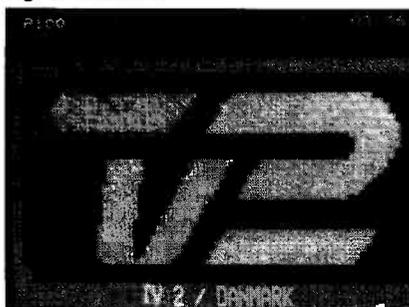

Fig. 6: Denmark.



Fig. 7: Germany.

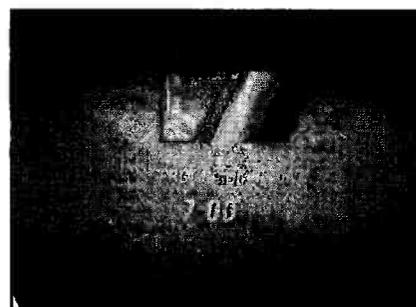

Fig. 8: Germany (Hamburg?).



Fig. 9: Germany.



Fig. 10: Italy.

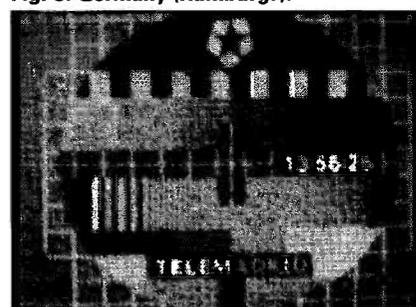

Fig. 11: Spain.



Fig. 12: Slow-scan Italy.

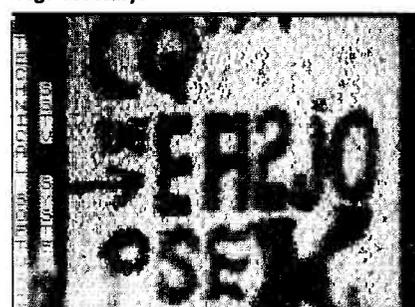

Fig. 13: Slow-scan Spain.

floating test-card on Ch. E3 and a cartoon film on Ch. R1 at 0750 on the 2nd. Around 0815 I tuned through Bands I and II with my R216 and heard weak sync-pulses on Chs. R2, E4, R3 (77.25MHz) and R4 (85.25MHz). During the following 15 minutes, the signals increased in strength and, using my Yoko TVC8M, I had pictures on Chs. R2, R3 and R4. Although the manufacturers do not claim this and perhaps the production batches vary but here was my chance to prove that my TVC8M would tune higher than Ch. E4 indicated on the dial. The vertical calibrated area for the radio and TV bands on this receiver is 65mm, but the calibration for Band I barely covers 15mm, thus leaving the remaining 50mm unmarked. However, while the high end was open, I tuned on downward and found Chs. R3 and R4 around 33 and 50mm respectively from the top. Fortunately for the experiment the same programme was coming from these 'R' channels and, by way of a bonus, my R216 produced the sound for Chs.

R3 and R4 on 83.75MHz and 91.75MHz.

## Picture Archives

David Glenday recently unloaded his camera and found colour pictures, dating back to July, of signals he received from Denmark showing the Tour de France, Fig. 5 and one of their 'tekst' idents, Fig. 6 on Chs. E37 and E30 respectively, Germany's 'ARD-1' caption celebrating their 40th anniversary, Fig. 7, on Ch. E51 and a rare one 'PRO7', on Ch. E46, probably from Hamburg, Fig. 8, which appeared at 0550 around the 20th.

## Tropospheric

David Glenday received u.h.f. pictures from Germany (ZDF) on Ch. E24 and Holland (PTT-Telecom) on Ch. E44 on August 23 and Holland (PTT NED 3) on Ch. E35 and programmes from the UK transmitters, "Tacolneston sitting on Selkirk" on the 25th. He also saw an unidentified concert from Denmark

or Holland on Ch. E30 at 2145 that evening and for a short time while the pressure was falling around 0900 on the 29th, I received pictures from France, on Ch. L9, in Band III.

Simon Hamer logged all the French 'TDF' Channels in Bands III, IV and V on August 10 and pictures from Eire, France and the Benelux countries in the same bands on September 2.

John Woodcock received negative pictures from France (Canal+) on August 22 and 24 and September 4 and 7. At the beginning of September **George Garden** (Edinburgh) was on holiday at Beaconsfield, Bucks, complete with his JVC CX610 portable receiver and amplified loop antenna. The TV weather map, on the 2nd, was showing a ridge of high pressure to the south of the British Isles and George found u.h.f. conditions good for a short period while the sky was bright and clear, between 0700 and 0930, on the 3rd.

His thoughts turned to DXTV and, from his hotel room, he received strong pictures, in colour with sound,

from BBC1 South from Rowridge (IOW) and TVS from Midhurst on Chs. 31 and 58 respectively. By 1000 the sky was overcast and the signals from these transmitters had gone. An interesting experiment George, we often learn about such things when a reader, like yourself, has been in the right place, at the right time and switched on the gear.

The prevailing steady high pressure varied on September 12 and 13 and while parked near Barcombe, Sussex, at 1700, on the 12th I heard a Dutch station on my Plustron TVR5D, with its own rod antenna in Band II around 101MHz. The weather looked right for an opening and although I had checked Bands II and III several times earlier in the day there were no indications of a lift until this Dutch station appeared. A little co-channel interference came up on some u.h.f. signals later that evening and next morning, from home, I received a test card from Belgium (BRT TV1) on Ch. E10. This mild opening persisted through the day and at 1645, I tried

# STEPHENS-JAMES LTD.

47 WARRINGTON ROAD, LEIGH, LANCS. WN7 3EA

Telephone (0942) 676790

Turn at the Greyhound Motel on the A580 (East Lancs. Road).



**SHOP HOURS**  
**Mon - Fri 9.30-5.00pm**  
**Sat 9.30-4.30pm**  
 24 HOUR MAIL ORDER SERVICE

## ANTENNA RANGE

CUSHCRAFT	
A3 3 Element Tribander Beam	£329.00
A4 4 Element Tribander Beam	£353.35
10-3CD 3 Element 10m Monobander	£115.04
15-3CD 3 Element 15m Monobander	£139.70
20-3CD 3 Element 20m Monobander	£238.21
AP8 8 Band Vertical 25ft High	£164.35
AP5 5 Band Vertical 25ft High	£150.00
18 Element 2m Boomer Antenna	£150.00
15 Element 2m Boomer Antenna	£96.00
Ringo Ranger 2m Vertical	£42.98
New R5 5 Band half wave vertical	£259.00
DW 10, 18, 24 MHz Rotary dipole	£159.00

<b>BUTTERNUT</b>	
HF 6VX 6 Band vertical Antenna	£167.00
HF 2V 80/40 metre Vertical	£142.00
A 1824 HF6V 17/12m Add on kit	£34.99
20MRK HF2V 20m Kit	£33.39

## FULL RANGE OF ACCESSORIES FOR THE BUTTERNUT RANGE

<b>HY-GAIN</b>	
TH2 Mk3 3 Element Tribander	£249.00
18AVT 5 Band Vertical	£146.00

<b>JAYBEAM</b>	
TB3 Mk3 3 Element Tribander	£365.00
TB2 MK3 2 Element Tribander	£246.00
TB1 MK3 Rotary Triband dipole	£123.30
VR3 MK3 Triband Vertical	£85.56
DB44 & 6m Element Beam	£139.37
4Y/4m 4m 4 Element Beam	£48.46
4Y/6m 6m 4 Element Beam	£58.05
LW8/2m 5 Element 2m	£22.53
LW8/2m 5 Element 2m	£28.28
PBM14/2m Parabeam	£83.05
5XY/2m 5 Element Crossed	£42.68
8XY/2m 8 Element Crossed	£54.60

<b>HAND HELD SCANNING RECEIVERS</b>	
WIN 108 Air band	£175.00
AOR1000 Handheld Receiver	£249.00
AOR900UK	£235.00
Base station Receiver AR2002	£487.00
NEW HF 225 general coverage receiver	£425.00

## KENWOOD RANGE

TS950SD HF Transceiver	£3,199.00
TS950S HF Transceiver	£2,499.00
SP950 Filtered Speaker	£87.50
TS940s HF Transceiver	£1995.00
AT940 Automatic Antenna tuner	£244.88
SP940 Speaker with filters	£87.55
TS440S HF Transceiver	£1138.81
AT440 Automatic Antenna tuner	£144.82
PS50 20 amp power supply	£222.49
TS140S HF Transceiver	£862.00
PS430 Power supply	£173.78
AT250 Automatic Antenna tuning unit	£366.00
AT230 Antenna tuning Unit	£208.67
SP230 Speaker with filters	£66.49
TL922 HF Linear amplifier	£1495.00
MC50 Base station microphone	£46.00
MC60A De Luxe desk microphone	£88.22
TR751E 2m Multimode Mobile Transceiver	£599.00
TR851E 70cm multimode transceiver	£699.00
TM231E 50watt 2m Transceiver	£289.00
TM431E 35watt 70cms Transceiver	£318.00
TM701E 25watt 2m/70cm Transceiver	£469.00
TS680S HF Transceiver + 6Metres	£995.00
TH25 2m FM Handheld Transceiver	£238.00
TH205E 2m FM Handheld Transceiver	£199.00
TH15E 2m Handheld FM Transceiver	£228.00
TH405E 70cm Handheld FM Transceiver	£245.00
R5000 General coverage receiver	£875.00
VC20 VHF Converter 108-174MHz	£167.21
R2000 General coverage receiver	£595.00
VC10 VHF Converter 118-174MHz	£161.95
HS5 De Luxe headphones	£37.54
TS790E Dual Bander Transceiver	£1495.00
LF30A Low Pass Filter	£32.26
SP50 Mobile Speaker Unit	£20.40
TH75E Handheld Dual Bander	£398.00

Full range of accessories stocked microphones. SWR meter, DC Leads, Antennas etc.

Full size G5RV Antenna £18.00. Half size £16.00. High Power 7MHz Traps £19.50. Diopie Kits £25.00. 3.7MHz traps £12.00. 200 watt. 8MHz traps £12.00.

AOR950 Base Station Receiver ..... £249.00

## TEN-TEC

We are pleased to announce we are now the official North West Stockist for the full range of the TEN-TEC range of HF equipment.

"Paragon" HF Transceiver with full general coverage receiver facilities. ..... £1839.90  
 "Corsair" MkII HF Amateur Band Transceiver. £1200.00  
 New Amateur Band only Transceiver "Omni V" ..... £1900.00

FULL RANGE OF ACCESSORIES AVAILABLE SEND S.A.E. FOR DETAILS

## MFJ ACCESSORIES RANGE

MFJ 1601 Random Wire Tuner	£45.00
MFJ 1701 6 way Antenna switch	£39.50
MFJ 949C Versatuner	£168.00
MFJ 941D Versatuner	£125.00
MFJ 901B Versatuner	£65.00
MFJ 300 watt dummy load	£33.50
MFJ RF Noise Bridge	£63.10
MFJ-931 Artificial Ground	£79.53
MFJ-962B 1kW Antenna Tuner	£291.95

## ROTATORS

G400RC	£169.00
G6600RC	£219.00
T2 X Heavy duty rotator	£399.00
CDE AR40	£168.72
CD 451 1R	£237.00
EMOTATOR 1057SY	£159.00

## POWER SUPPLIES

PS30M Heavy duty 30A, 22A cont	£129.50
PS120M 3-15V variable 12A max	£79.50

Postage/ carriage at cost. We are also stockist for Global, Datong, and have a full range of publications by RSGB-ARRL and others. Our secondhand list is updated daily. Please send SAE for this or any information.

## YAESU

# Reg Ward & Co. Ltd.

1 Western Parade, West Street, Axminster, Devon EX13 5NY  
 Tel: (0297) 34918

## KENWOOD

**YAESU FRG 8800** ..... £649.00



Super HF/VHF receiver (VHF option) LCD direct readout with 8-bit CPU function control. 21 button keypad entry or V.F.O. frequency selection. Full general coverage 150kHz.

29.999MHz AM/FM/LSB/USB/CW. 12 memories with back up. 100/120/220/240V plus 12V d.c. operation (optional). Clock and timer on/off control - socket. FRV8800 VHF CONVERTIBLE £1000.00 (1180174MHz direct read out - plug in) FRVWFM £49.00 (wide band FM unit)

**FRT7700 Receive ATU 150kHz-30MHz** ..... £59.00 carriage £3.50

**YAESU FRG9600** ..... £499.00 (60-905MHz)

**FRG9600M 60-950MHz** ..... £509.00



All mode scanning receiver covering 60-905MHz (60-905 9600M) continuously with 100 keypad programmable memory channels. Full, limited or memory scanning.

Optional accessories D130 Discone antenna £75.00 carr. £4.00 PA4C power supply £25.00 carr £2.50. FC965 DX Ext converter £89.00 carr £3.00. FC1300 Ext converter £119.00 carr. £3.00.

## HANDY SCANNERS!

**HX850E REGENCY** new low price ..... £179.00 carriage £4.00  
 20 Channel memory AM/FM selectable scanner 60-89MHz, 118-136MHz, 140-174MHz, 406-495MHz

**AR800 VHF/UHF** ..... £169.00 carriage £4.00  
 Handheld scanner 75-105, 118-174 406-495 830-950MHz

**AR900 VHF/UHF Handheld** 108-174, 220-280 300-380, 401-470, 830-950MHz ..... £199.00 carriage £4.00

**AR1000 VHF/UHF** ..... £249.00 carriage £4.00  
 8-1300MHz 1000 memories.

**JUPITER II Handheld** 25-550MHz 800-1300MHz ..... £275.00 carriage £4.00

**BEARCAT UBC 200XL** ..... £229.00 carriage £4.00  
 66-88 136-174 406-512 806-956MHz

## ICOM

**IC-R71E HF Receiver** ..... £855.00



100kHz-30MHz CW/SSB/AM/RTTY/FM (optional). Direct frequency entry. 32 memories. Scanning. Remote control and 12 volt d.c. option.

**IC-R7000VHF/UHF** ..... £989.00  
 Continuous coverage receiver. 25MHz: 2000MHz FM/AM/SSB modes direct frequency entry. 99 memories. Scanning, remote control option.

## NEW

**R100 Mobile/Base Scanner** 500kHz-1800MHz ..... £499.00 carriage £4.00

**R1 Handheld scanner** 150kHz-1300MHz ..... £399.00 carriage £4.00

**R72 HF Receiver** 100kHz-30MHz ..... £645.00

## SONY

**ICFPRO80** ..... £299.00

- ✓ Super-wide coverage (PRO80) - 150kHz - 108MHz plus 115.15MHz 223MHz; PRO70 - 150kHz - 108MHz \*\*
- ✓ Pro-feel 8 way tuning system
- ✓ 40-station random preset memory
- ✓ 2-position AM selectivity
- ✓ SSB and narrow FM reception
- ✓ Squelch controller (auto & manual)

**AIR7** ..... £229.00

- ✓ AIR band/FM/AM reception
- ✓ Compact, hand-held design
- ✓ Quartz PLL-synthesizer digital tuning.
- ✓ Microprocessor control of direct, scan, present tuning, plus the program, priority and delayed scan functions for AIR band
- ✓ 30 - station preset memory (10 per band)
- ✓ Front-panel oval speaker
- ✓ Rubber-booted helical antenna.
- ✓ Carrying belt and earphone.

**ICF 2001D** ..... £299.00  
 Super-wide coverage (150-2999.9kHz 76-108MHz, 116-136MHz) with the versatility of both digital and "precise-feel" analog tuning. There's also two types of scan modes, either auto-stop or 1.5 second hold, 2-position AM selectivity, AM RF-gain control, AM attenuator, 3-position tone control, direct meter band access, 4-event programmable time and SSB\* reception. Plus an external antenna for AM, FM and AIR Band. In short, everything an enthusiast could ever want in a high-performance receiver - and can only get from Sony!

**KENWOOD R5000** ..... £875.00



The frequency range is continuous from 100kHz to 30MHz and its modes of operation are USB, LSB, CW, AM, FM and FSK. An optional VHF converter (VC20) extends the frequency range to include 108 to 174MHz.

**R2000** ..... £595.00  
 This is an innovative all-mode SSB, CW, AM, FM receiver that covers 150kHz-30MHz. With an optional VC-10VHF converter unit, coverage of the 118-174MHz frequency range is possible. New microprocessor controlled operating features and an "UP" conversion PLL circuit assure maximum flexibility and ease of operation.

**LOWE HF-225** ..... £425.00



carriage £5.00 Coverage is continuous from 30kHz to 30MHz and operating modes are AM, USB, LSB and CW with an optional FM and synchronous AM board. A comprehensive range of bandwidth filters are standard: 2.5, 4, 7 or 10kHz.

## BASE/MOBILE SCANNERS

**JUPITER BASE STATION MVT6000**  
 25-550MHz 800-1300MHz 12VDC or 24VAC 100 memories 5, 10, 12.5, 25 or 30kHz steps ..... £345.00 carriage £5.00

**KENWOOD R21** 100kHz-955MHz ..... £465.00 carriage £4.00

**AOR AR2002** 26-550 800-1300MHz. 12VDC or 24VAC ..... £487.00  
**AOR AR3000** 100kHz-2036MHz ..... £765.00 carriage £8.00

## ANTENNAE!

**DATONG AD370** HF O/Door Act. Ant ..... £77.62 carriage £4.00  
**DATONG AD270** HF Indoor Act. Ant ..... £58.22 carriage £3.00  
**D 130-26** 1300kHz ..... £75.00 carriage £4.00  
**DSC 770** 70-700MHz ..... £24.95 carriage £4.00

OPEN TUES - SAT. 9.00-5.30 (CLOSED MONDAYS) STOCK ITEMS USUALLY DESPATCHED WITHIN 48 HOURS Instant credit available. Mail/Telephone order by cheque or credit card. Cheques cleared before goods despatched.

# SEEN & HEARD

the Plustron at Goodwood, Sussex and found negative pictures from France on Ch. L9.

## Satellite TV

**Les Jenkins** (Godalming) has assembled his satellite receiving equipment from various suppliers and to date, with a 1m dish antenna

he has received pictures from Germany (RTL), Fig. 9, Italy (RAI), Fig. 10 and Spain (Madrid), Fig. 11, from Eutelsat 1 F4, F5 and F2 respectively. "Satellite television available in the UK - or at least in Devon," wrote **Robin Clark** (Wembury) is Astra 19.2° east, Eutelsat 1 F4 13° east, Eutelsat 1 F5 10° east, Intelsat VAF11 27.5° west, Intelsat VA F12 1° west, Telecom 1C

5° west and DFS Kopernicus 1 23.5° east. Thanks lads, all interesting stuff.

## SSTV

During the past few months, **Steve Charles** (Rustington) using a Lowe HF-125 receiver, Spectrum computer with RX4 program and Alphacom 32 printer, copied slow-scan television

pictures, around 14.230MHz, from Bulgaria (LZ2KAF), Germany (DL0BUF), Italy (I1CEL), Fig. 12 and Spain (EA1ACT and EA2JO), Fig. 13. He also logged and printed-out such captions as 'PSE K', 'MY NAME PEDRO MY QTH SANTANDER' and '73 73 73 THANK YOU GOOD BYE ADIOS'.

## LONG MEDIUM & SHORT

Brian Oddy G3FEX  
Three Corners, Merryfield Way, Storrington,  
West Sussex RH20 4NS

By international agreement s.w. broadcasters are able to change their operating frequency and schedule on the first Sundays of March, May, September and November to take account of seasonal changes in the propagation conditions. But, not all broadcasters comply with the agreement and some make changes with little or no warning.

The information detailed in this column is based on the reception reports sent in by SWM readers and on my own observations. Soon after this issue is published some of the broadcasters will change their frequency, so please inform me of any changes you hear.

## Long Wave DX

Note: l.w. & m.w. frequencies in kHz; s.w. in MHz; Time in UTC (=GMT).

In Edinburgh, **Kenneth Buck** noted an improvement in l.w. reception during the month. He says, "Unfortunately Atlantic 252 has been heard as late as midnight, but apparently on reduced power. This has prevented the reception of Lahti and Tipaza on the same frequency". He found the signals from Kaliningrad 171, Montala 189, Oslo 216 and Topolna 270 were all stronger than last month. After dark, he noted a marked increase in the strength of signals from Roumoules 216 and Topolna 270kHz. An improvement was also noted by **Scott Caldwell** in Warrington. It enabled him to add several stations to his list of DX.

While away in north Scotland, **John Stevens** checked the bands with a small portable as he travelled along the coast from Cape reception has been noted from many areas in the h.f. bands, from time to time solar flares have resulted in a sudden

ionospheric disturbance (s.i.d.) and reception was disrupted for a while. Such events are likely to continue.

The **25MHz (11m)** experimental transmissions from R. HCJB in Quito, Ecuador on 25.950 can now be clearly received here during much of the day. At 0730, **David Edwardson** rated their signal in Wallsend as SINPO 35543. In Manchester, **Harold Wood** noted it as 54434 at 1215. Later, **Darren Beasley** (Bridgwater) logged it as 45434 at 2145. At present their 30kW u.s.b. plus pilot carrier transmissions are directed towards Europe and South Pacific areas, but they are being received in other areas.

In Quebec **Alan Roberts** has monitored their transmission on most days, but the signal level is generally too weak to ensure that the pilot carrier will lock the synchronous detector in his receiver. At best he rated HCJB as 45344 at 1230; R. Moscow 25.680 as 15222 at 1255; SRI 25.680 as 45555 at 1410; RNI 25.730 (u.s.b. + carrier) as 35444; R. DW 25.740 as 25433 at 1350; R. Moscow 25.780 as 25433 at 1240; R. Yugoslavia 25.795 as 25433 at 1225; RFI 25.820 as 45555 at 1350; BBC 25.780 as 35444 at 1220.

Some of R. Australia's **21MHz (13m)** broadcasts have been reaching the UK. Their transmission to C. Pacific areas via Shepparton 21.740 (Eng 2200-0730) was rated 34343 at 2230 by Cliff Stapleton; to C. Asia via Darwin 21.525 (Eng 0100-0900) as 24542 at 0615 by David Edwardson; to S. Asia via Carnarvon 21.775 (Eng 0100-1100) as 44543 at 0820 by Ron Damp in Worthing; to E. Asia via Darwin 21.825 (Eng 1100-1230) as 33333 at 1121 by Jim Cash in Swanwick.

During the day there are many broadcasts to Europe. Those noted stemmed from the Voice of Israel, Jerusalem 21.760 (Heb 0515-1645),

noted as 45554 at 0605 by **John Parry** in Northwich; R. Japan via Yamata 21.500 (Russ, Sw, It, Ger, Fr, Eng, Jap 0530-0830), 44444 at 0700 by Sheila Hughes; also relayed via Moyabi, Gabon 21.690 (0530-0830), 22111 at 0709 by **Robin Harvey** in Bourne; R. Pakistan, Islamabad 21.520 (Eng 1100-1120), SIO444 at 1100 by **John Coulter** in Winchester; WCSN Scotts Corner, MN 21.780 (Eng 1400-1600), 44333 at 1409 by Robin Clark; R. Japan via Moyabi, Gabon 21.700 (Eng, Jap 1500-1700), 45333 at 1525 by **John Nash** in Brighton; UAE R. Dubai 21.605 (Ar, Eng 0600-1645), 55544 at 1615 by **Darran Taplin** in Brenchley; RCI via Sackville, Canada 21.545 (Russ, UK, Fr, Pol, Ger, Eng 1330-1700), SIO544 at 1620 by **Aif Gray** in Birmingham; RCI via Sackville, Canada 21.675 (Eng 1830-1859), 45544 at 1858 by **Andy Cadier** in Folkestone; R. HCJB Quito, Ecuador 21.480 (Eng 1900-?) SIO354

at 1900 by Kenneth Buck; WYFR via Okeechobee, FL 21.615 (Eng, Ger, It 1600-2145) 43433 at 2100 by **John Sadler** in Bishops Cleeve.

Some of the many broadcasts to other areas may also be heard here: R. Prague, Czechoslovakia 21.705 (Eng, Cz to SE. Asia, Australia 0630-0730), noted as 54344 by **Chris Shorten** in Norwich; BSKSA Riyadh, Saudi Arabia 21.505 (Ar to N. Africa, S. Europe 1100-1700) SIO444 at 1453 by **Philip Rambaut** in Macclesfield; R. Sweden via Horby 21.500 (Sw, Fr, Eng to USA 1430-1600) 35444 at 1530 by **Eddie McKeown** in Co. Down; WCSN Scotts Corner, MN 21.640 (Eng to E/N. Africa 1600-1955) SIO544 at 1805 by **Ron Pearce** in Bungay; WSHB Cypress Creek, USA 21.780 (Eng, Fr to E. USA 1800-1955) 55545 at 1955 by Darren Beasley.

There is plenty to interest the DXer in the **17MHz (16m)** band! The broadcasts to Pacific areas from R.

## Long Wave DX Chart

Freq (kHz)	Station	Location	Power (W)	DXer
153	DLF Donebach	Germany (W)	500	B,D,H,I*,K*,L,M,O
162	Allouis	France	2000	A*,B,D,I*,J,K*,L,M,N,O
171	Kaliningrad	USSR	1000	B,D,I*,K*,O
171	Moscow	USSR	500	H
177	Oranienburg	Germany (E)	750	B,H*,I*,K*,M,O
183	Saarouis	Germany (W)	2000	B,D*,I*,K*,L,M,O
189	Motala	Sweden	300	B,D*,H
189	Tbilisi	USSR	500	D*,H
198	BBC Droitwich	UK	500	A*,I,J,K*,L,N,O
198	BBC Westerglen	UK	50	B
207	DLF Munich	Germany (W)	500	B,D*,I*,L,M,O
216	Roumoules	Monaco	1400	B*,I*,J,K*,L,M,O
216	Oslo	Norway	200	B,D,H,I*
225	Konstantinow	Poland	2000	B,I*,K*,M*,O
234	Junglinster	Luxembourg	2000	A*,B,D,I*,K*,L,M,O
243	Kalundborg	Denmark	300	B,O,H,I,K*,L,M,O
252	Tipaza	Algeria	1500	D*,H*,I*
252	Lahti	Finland	200	E
252	Atlantic 252	S. Ireland	500	A,B,C,D,E,F,G,H I,J,K*,L,M,N,O D*,H,I,K*,L,O
261	Burg (R.Volga)	Germany (E)	200	B
261	Moscow	USSR	2000	B
270	Topolna	Czechoslovakia	1500	B*,D*,H*,I*,K*,M*
279	Minsk	USSR	500	B*,H*,K*

Note: Entries marked \* were logged during darkness. All other entries were logged during daylight.

## DXers:

A. Ted Agombar, Norwich.  
B. Kenneth Buck, Edinburgh.  
C. Andy Cadier, Folkestone.  
D. Scott Caldwell, Warrington.  
E. Robin Clark, Plymouth.  
F. Francis Hearne, Bristol.  
G. John Hepburn, Ashington.  
H. Simon Holland, Douglas, IOM.  
I. Sheila Hughes, Morden.  
J. Mark Mahabir, Leicester.  
K. Eddie McKeown, Co. Down, N. Ireland.  
L. George Millmore, Wootton, IOW.  
M. Fred Pallant, Storrington.  
N. John Stevens, while in N. Scotland.  
O. Phil Townsend, London.

# Amtor

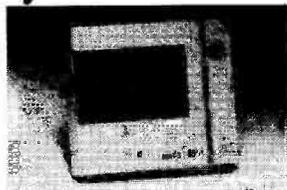

## AMT-3 Amtor/ RTTY Terminal Unit

Bored with simply sending packet messages via mailboxes on VHF? Itching to have a live QSO with someone on the other side of the globe again? Try Amtor. Amtor is by far the most reliable method of HF data communication, and the AMT-3 has been optimised to get the best from the mode. The AMT-3 is a third generation product from ICS, with firmware by G3PLX, the 'father' of Amtor.

- Compact packaging
- Status displays, tuning indicator
- RTTY transceiver
- CW ident
- Includes IBM-PC software
- 12 volt DC operation

Amtor gives virtually error free copy, even with poor signals, and yes, HF mailboxes with local VHF packet links can be accessed.

AMT-3: £179.95 inc. VAT  
(£5.00 post and packing)



ICS Electronics Ltd. Unit V, Rudford Industrial Estate, Ford, Arundel, West Sussex BN18 0BD





# SEEN & HEARD

New Zealand Int., Wellington on 17.675 (Eng 2205-0710 Mon-Fri; 0000-0645 Sat; 0200-0800 Sun) have been clearly received in the UK during some mornings. At 0445, Chris Shorten rated them as 44344. Some of R. Australia's broadcasts have also been audible here during the day. Their transmission to E/C. Asia via Carnarvon 17.630 (Eng, Fr 0000-1100) rated SIO212 at 0755 by Philip Rambaut; to the Gulf area via Carnarvon 17.630 (Eng 1300-1630?) as 32322 at 1330 by Jim Cash; to C.Pacific areas, W.USA 17.795 (Eng, Fr 2100-0830) as 24122 at 2120 by Eddie McKeown; to SE. Asia via Shepparton 17.715 (2200-0000) as 43434 at 2210 by Cliff Stapleton.

Many broadcasts to areas outside Europe are also received here. Some noted were R. Beijing, China 17.710 (Eng to Australia 0830-1035) 24532 at 0908 by David Edvardson; BFBS via BBC Limassol, Cypress 17.695 (Eng to Gulf area 0930-1000) SIO333 by Simon Hamer; Voice of Israel, Jerusalem 17.575 (Eng 1100-1130, also to USA) 34433 at 1130 by **Donald Blashill** in Cheltenham; Voice of Greece, Athens 17.535 (Gr, Eng, Sw to USA 1500-1550) 55555 at 1530 by John Nash; R. Moscow, USSR 17.695 (Eng to S. Asia 1530-1700) 44333 at 1630 by Sheila Hughes; R. RSA Johannesburg, S. Africa 17.790 (Eng to Africa 1700-1800) 54444 at 1700 by **Denis Boshier** in Dolgellau; KHBI Saipan, N. Mariana Islands 17.555 (Eng to E. Asia 1800-1955) 43343 at 1903 by **Alan Smith** in Northampton; RCI via Sackville, Canada 17.820 (Eng, Fr to Africa 1800-2000) 45444 at 1930 by Darran Taplin; RHC Havana via USSR 17.875 (Ar, Fr, Eng 1800-2100) 33443 at 2017 by Andy Cadier; VOA via Greenville, USA 17.785 (Eng to W. Africa 1600-2200) 33333 at 2030 by Robin Harvey; BBC via Greenville, USA 17.715 (Eng to C. America 2100-2130) SIO344 at 2115 by **Neil Wheatley** in Lytham St. Annes.

The broadcasters using 16m to reach Europe include R. Pakistan, Islamabad 17.555 (Eng 1600-1630) SIO344 at 1625 by Kenneth Buck; RCI via Sackville, Canada 17.875 (Fr, Eng 2030-2200) 43344 at 2102 by **Leo Barr** in Sunderland; WYFR via Okeechobee, FL 17.750 (Eng, Ger, Fr, It, Sp 1900-2245) SIO444 at 2145 by Alf Gray; R. HCJB Quito 17.790 (Cz, Ger, Eng, Sw, Norw, Da, Fr, Sp 1800-2230) 54554 at 2200 by Darren Beasley; VOFC Taiwan via Okeechobee 17.845 (Chin, Ger, Fr, Eng 1900-2300) SIO444 at 2200 by Francis Hearne.

The **15MHz (19m)** broadcasts from R. New Zealand Int, Wellington on 15.485 (Eng 1745-2205 Mon-Fri, 1845-2205 Sun) have attracted the attention of many DXers in the UK. Leo Barr logged their signal for the first time and rated it as 22322 at 1930. Some broadcasts from R. Australia have also been reaching Europe. Their transmission to C/W. Pacific areas via Shepparton 15.560 (Eng 0040-0600) was rated as 35553 at 0557 by David Edvardson; to SE. Asia via Shepparton 15.465 (Eng 2100-0730) as 54555 at 0715 by **Bill Griffith** while in La Clusaz, French Alps and as SIO333 at 2215 by Francis Hearne; to C. Pacific, W. USA via Shepparton 15.160 (Eng, Fr 0030-0830) as 33232 at 0800 by Alan Smith; to S. Pacific via Shepparton 15.240 (Eng 2200-0830) as 44444 at 0800 by Sheila Hughes; to C. Asia via Darwin 15.170 (Chin 2200-2300) as

## Local Radio DX Chart

Freq kHz	Station	ILR BBC	Power kW	DXer	Freq kHz	Station	ILR BBC	Power kW	DXer
558	Spectrum R	I	7.50	E,F,J,M,D,P,R*,V*	1170	R. Orwell	I	0.28	A,V
585	R. Solway	I	2.00	C,L*,V*	1170	Signal R	I	0.20	C*,E
603	Invicta Snd (Coast)	I	0.10	E,J,M,V*	1170	Swansea Sound	I	0.58	N
603	R. Gloucester	I	0.10	E,K,M,V*	1170	TFM Radio (GNR)	I	0.32	L*
630	R. Bedfordshire	B	0.20	A,E,J,K,M,U,V*	1242	Invicta Snd (Coast)	I	0.32	C,J,N*,V
630	R. Cornwall	B	2.00	IL*,M*	1242	Isle of Wight R	I	0.50	D*,I*,K*,L*,M*,S*,V
657	R. Chywell	B	2.00	C*,E,J,K,M,T,V*	1251	Saxon R	I	0.76	A*,E,I*,J,L*,O,P*,V
666	Devon Air R	I	0.34	J,K,L*,M,V*	1260	GWR (Brunel R.)	I	1.60	J,M,N,V
666	R. York	B	0.80	E,I,J,V*	1260	Leicester (GEM-AM)	I	0.29	C,E,J,K,U,V
729	BBC Essex	B	0.20	A,E,J,K,M,P,V*	1260	Marcher Sound	I	0.64	C
738	Hereford/Worcester	B	0.037	E,K,N,T,V*	1278	Pennine R. (C. Gold)	I	0.43	C
756	R. Cumbria	B	1.00	N	1305	R. Hallam (C. Gold)	I	0.15	E,V
756	R. Shropshire	B	0.63	E,K,L*,M,N,T,V*	1305	Red Dragon (Touch)	I	0.20	G,I,J,L*,M,N,V
785	BBC Essex	B	0.65	E,J,K,M,N,V*	1323	R. Bristol	B	0.63	E,N,V
774	R. Kent	B	0.70	A,E,J,M,V*	1323	Southern Sound	I	0.50	E*,J,M,V
774	R. Leeds	B	0.50	B,C,I,P	1332	Hereward R	I	0.60	E,J,L*,O*,U,V
774	Severn Sound	I	0.14	E,K,N	1332	Wiltshire Sound	B	0.30	E,J,M
782	Chiltern R	I	0.27	E,J,K,M,U,V*	1359	Essex R. (Breeze)	I	0.28	E,J,V
801	R. Devon	B	2.00	E,K,L*,M,N,V*	1359	Mercia Snd (Xtra-AM)	I	0.27	E,K,V
819	Hereford/Worcester	B	0.037	E,K,L*,M,N,V*	1359	Red Dragon (Touch)	I	0.20	G
828	Chiltern Radio	I	0.20	J,K,U,V*	1359	R. Solent	B	0.85	L*,M
828	R. Aire	I	0.12	B	1368	R. Lincolnshire	B	2.00	E,K,V
828	R. WM	I	0.20	C*,E,N	1368	R. Sussex	B	0.50	J,M,T
828	2CR	I	0.27	G,M	1368	Wiltshire Sound	B	0.10	C
837	R. Cumbria	B	1.50	C,N	1413	Sunrise R	I	?	M,T
837	R. Leicester	B	0.45	E,J,K,M,N,T,U,V	1431	Essex R. (Breeze)	I	0.35	E,J,T,V
855	R. Devon	B	1.00	K,M,N	1431	Radio 210	I	0.14	J,L*,M
855	R. Lancashire	B	1.50	C*,E,N	1449	R. Cambridgeshire	B	0.15	E,V
855	R. Norfolk	B	1.50	A,E,J,K,M,V	1458	GLR	B	50.00	E,J,M,N*,U,V
873	R. Norfolk	B	0.30	C*,E,J,K,M,V	1458	GMR	B	5.00	L*,N*
936	GWR (Brunel R.)	I	0.18	E,J,M,N,O	1458	R. Cumbria	B	0.50	N
945	R. Trent (GEM-AM)	I	0.20	C*,E,I,K,L*,M,N,U,V	1458	R. Devon	B	2.00	K,M,N
954	Devon Air R	I	0.32	D*,K,M,N	1458	R. Newcastle	B	2.00	C*,L*
954	R. Wymern	I	0.16	E,N,V	1458	Radio WM	B	5.00	E,K,L*
990	Beacon (Nice&Easy)	I	0.09	E,K	1475	C*tySnd(1stGold)	I	0.50	E,J,L*,M,V
990	R. Devon	B	1.00	K,L*,M,N	1485	R. Humber-side	B	1.00	E,V
990	Hallam R. (C. Gold)	I	0.25	E,I,V	1485	R. Merseyside	B	1.20	C*,N
990	Spectrum	I	?	J	1485	R. Oxford	B	0.50	E,M,V
999	R. Solent	B	1.00	J,M,V	1485	R. Sussex	B	1.00	J,M
999	R. Trent (GEM-AM)	I	0.25	E,K,U,V	1503	R. Stoke-on-Trent	B	1.00	C,E,K,M,N,V
999	Red Rose R	I	0.80	B,C*,L*,N	1521	R. Mercury	I	0.64	J*,M,V
1026	R. Cambridgeshire	B	0.50	A,E,J,K,T,V	1521	R. Nottingham	B	0.50	E,K,R*,V
1026	R. Jersey	B	1.00	M,N,P	1530	KCBC Kettering	I	0.025	E,K,U,V
1035	Northsound Radio	I	0.78	E*,H,N*	1530	Pennine R. (C. Gold)	I	0.74	L*
1035	R. Kent	B	1.50	J,M,T,V	1530	R. Essex	B	0.15	J
1035	R. Sheffield	B	1.00	E,I	1530	R. Wymern	I	0.52	E,M,N
1107	R. Northampton	B	0.50	A,E,J,K,M,U,V	1548	Capital R. (Gold)	B	37.50	J,M,V
1116	R. Derby	B	1.20	E,K,V	1548	R. Bristol	B	5.00	L*,M,N
1116	R. Guernsey	B	0.50	J,M,N,V	1548	R. City (CityTalk)	I	4.40	C*,N
1152	BRMB (Xtra-AM)	I	3.00	E	1548	R. Forth (MaxAM)	I	2.20	E*,L*
1152	LBC (L. Talkback R)	I	23.50	J,M	1548	R. Hallam (C. Gold)	I	0.74	E
1152	Piccadilly R	I	1.50	C*	1557	Chiltern R	I	0.74	E
1152	Plymouth Sound	I	0.32	N	1557	Ocean Sound (C. Gold)	B	0.50	E*,M
1152	R. Broadland	I	0.83	A,L*,N*,V	1557	R. Lancashire	B	0.25	N
1152	R. Clyde (Clyde2)	I	3.60	N*	1584	Watwick	I	?	J*,M,R*
1161	GWR (Brunel R.)	I	0.16	E,N	1584	Heathrow	I	?	F,J*,M,P*,V
1161	R. Bedfordshire	B	0.10	E,U,V	1584	R. Nottingham	B	1.00	E,K,R*,V
1161	R. Sussex	B	1.00	J,M,P	1584	R. Shropshire	B	0.50	N
1161	R. Tay	I	1.40	L*,N*	1602	R. Kent	B	0.25	F*,J,M,O,T,V
1161	Viking R. (C. Gold)	I	0.35	E,V					
1170	Ocean Sd. (C. Gold)	I	0.12	J,M					

### DXers:

A: Ted Agombar, Norwich.  
 B: Leo Barr, Sunderland.  
 C: Scott Caldwell, Warrington.  
 D: Robin Clark, Plymouth.  
 E: Jason Faulkner, Leicester.  
 F: Ted Gould, London.  
 G: Francis Hearne, Bristol.  
 H: John Hepburn, Ashington.  
 I: Simon Holland, Douglas.  
 J: Sheila Hughes, Morden.  
 K: Mark Mahabir, Leicester.  
 L: Eddie McKeown, Co. Down.  
 M: George Millmore, Wootton.  
 N: Bart O'Brien, Co. Wexford.  
 O: Roy Patrick, Derby.  
 P: Tim Shirley, Bristol.  
 Q: Chris Shorten, Norwich.  
 R: Alan Smith, Northampton.  
 S: Cliff Stapleton, Torquay.  
 T: Phil Townsend, London.  
 U: Paul Weston, Kettering.  
 V: David Wratten, Cambridge.

34343 at 2200 by Cliff Stapleton.

A number of broadcasts to Europe were noted: R. HCJB Quito, Ecuador 15.270 (Eng 0700-?) as 55555 at 0850 by Donald Blashill; RTL Luxembourg 15.350 (Eng 1000-1400, Fr 1400-1000, also to E. USA), noted as 'good' from 1000-1300 by **Roy Patrick** in Derby, also heard in Quebec at 1400 by Alan Roberts; RNB Brasilia, Brazil 15.265 (Eng, Ger 1800-1950), heard at 1800 by **Cyril Kellam** in Sheffield; Voice of Vietnam, Hanoi 15.010 (Eng, Russ, Viet, Fr, Sp 1600-2130) SIO333 at 1820 by **Ted Walden** in Gt. Yarmouth; VOIRI Tehran, Iran 15.084 (Sp, Ar, Fa, Tur, Fr 24hrs) SIO444 at 1821 by John Coulter; R. Sophia, Bulgaria 15.330 (Eng, Ger, It, Fr 1830-0025, also to USA) 54554 at 1841 by **Roy Spencer** in Coventry; RNE via Aganda, Spain 15.280 (Ger, Russ, Fr, Eng 1700-2157) 44434 at 1909 by **Ted Agombar** in Norwich; Voice of Israel, Jerusalem 15.640 (Yi, Heb, Eng, Fr 1645-1955) 54544 at 1912 by Jim Cash; VOA via Tanger, Morocco 15.205 (Eng 1700-2200) 54554 at 1924 by Robin Clark; WWVC Nashville, USA 15.690 (Eng 1200-0100) SIO433 at 2015 by Alf Gray; R. Damascus, Syria 15.095 (Ger, Fr, Eng 1805-2105) 54343 at 2020 by Darren Beasley; R. Korea, Seoul 15.575 (Ar, It, Eng, Sp Port, Ger 1645-2300) SIO444 at 2039 by Ron Pearce; R. Yugoslavia, Belgrade 15.105 (Eng 2100-2145, also to USA) 44433 at 2102

by Darran Taplin; WCSN Scotts Corner, Maine 15.610 (Eng 2000-2155, also to N. Africa) 53433 at 2139 by John Sadler; RAE Buenos Aires, Argentina 15.345 (Ar, Eng, Ger, Fr, It 1800-2300, also to N. Africa) SIO433 at 2215 by Philip Rambaut.

Throughout the day there are numerous broadcasts to other areas. Among those logged in the UK were SRI via Schwarzenburg, Switzerland 15.430 (Ger, Fr, Eng, It to Africa 0545-0730) noted as 33553 at 0640 by John Parry; R. Romania Int, Bucharest 15.335 (Eng to SE. Asia, Australia 0645-0715) 54333 at 0650 by Chris Shorten; R. Netherlands via Bonaire,

Ned. Antilles 15.560 (Eng to New Zealand 0730-0825) 43344 at 0745 by Eddie McKeown; BFBS via BBC 15.205 (Eng to Gulf area 0930-1000) SIO444 by Simon Hamer; UAE R. Dubai 15.320 (Ar, Eng to N. Africa, Mid East 0600-2050) SIO444 at 1615 by Kenneth Buck; SLBC Colombo, Sri Lanka 15.120 (Eng to ?) 42543 at 1835 by John Nash; RNE via Noblejas, Spain 15.375 (Eng, Fr to Africa 1900-2057) SIO544 at 1916 by **Thomas Barnett** in Slough; R. Portugal, Lisbon 15.250 (Port, Eng, Fr to Africa 1400-2100) 55544 at 2030 by Andy Cadier.

In the **13MHz (22m)** band, good reception has often been noted from WSHB Cypress Creek, USA 13.760 (Eng, Sp to C. America 0400-0555), rated 55545 at 0430 by Chris Shorten; WYFR via Okeechobee, FL 13.760 (Eng to Europe 0600-0745) - 44444 at 0713 by Leo Barr; R. Austria Int, Vienna 13.730 (Ger, Fr, Eng, Sp, Ar to Europe 0400-1700) 55555 at 0738 by Andy Cadier; R. Australia via Shepparton 13.705 (Eng to C. Pacific areas 0600-0830) 43344 at 0830 by Donald Blashill; R. Jordan, Al Karanah 13.655 (Eng to Europe 0500-1315) 45554 at 1300 by John Parry; R. Australia via Carnarvon 13.745 (Eng to S. Asia 1430-1700) SIO444 at 1600 by John Stevens; R. Bangladesh, Dacca 13.615 (Ur to ? 1600-?) SIO333 at 1630 by Philip Rambaut; Voice of the UAE Abu Dhabi 13.605 (Ar to N. Africa, S. Europe 1600-2135) SIO344 at 1650 by Kenneth



Darran Taplin's listening post.

# SEEN & HEARD

Buck; WHRI Noblesville, USA 13.760 (Eng, Sp, Port, Yu to E.USA, Europe 1700-0000) 34233 at 1930 by John Nash; R. Baghdad, Iraq 13.660 (Eng to Europe 2000-2200) SIO555 at 2000 by Neil Wheatley; ISBS Reykjavik, Iceland 13.855 (Ic to Europe 1855-1930) 44333 at 1855 by Sheila Hughes; SRI via Sottens, Switzerland 13.635 (Ger, Fr, It, Pol, Eng, Sp to E.Africa 1900-2200) 44344 at 2105 by Eddie McKeown; R. DW via Julich, Germany 13.780 (Eng to S/S.E.Asia 2100-2150) 43433 at 2112 by Jim Cash; WSHB Cypress Creek, USA 13.770 (Eng to E.USA, Europe 2000-2155) 54444 at 2140 by Ron Damp; R. Australia via Darwin 13.605 (Eng to E.Asia 2200-0100) SIO322 at 2200 by Alf Gray; BFBS via BBC Limassol, Cyprus 13.745 (Eng to Gulf area) 24532 at 0202 by David Edwardson.

The **11MHz (25m)** broadcasts to Europe include R. Sophia, Bulgaria 11.720 (Ger, Fr, Eng 0530-0700) rated 33423 at 0630 by Harold Wood; R. HCJB Quito, Ecuador 11.835 (Eng 0700-0830) - 43433 at 0740 by **Ted Gould** in London; WCSN Scotts Corner, MN 11.710 (Eng) 55555 at 0800 by Bill Griffith (France); TWR Monte Carlo, Monaco 11.655 (Eng 0855-1005) 55555 at 0920 by Darren Beasley; R. Romania Int, Bucharest 11.940 (Eng 1300-1400) 44444 at 1350 by John Nash; RFI via Issoudun, France 11.670 (Fr, Eng, Russ, Uo, Ro, Pol 0600-2100) SIO444 at 1547 by John Coulter; Voice of the UAE in Abu Dhabi 11.965 (Ar 1600-2135) SIO444 at 1630 by Kenneth Buck; R. Finland via Pori 11.755 (Fin, Sw, Ger, Eng, Fr 0700-2230) 54554 at 1834 by Roy Spencer; R. Sophia, Bulgaria 11.660 (Ger, It, Fr, Eng 1830-2100) 33333 at 1937 by Ted Agombar; R. Damascus, Syria 12.085

(Ger, Fr, Eng 1805-2105) 33433 at 2042 by Eddie McKeown; R. Beijing, China 11.500 (Russ, Ger, Eng 1700-2155) 54544 at 2050 by Andy Cadier; R. Sweden via Horby 11.705 (Eng, Sp, Sw 2100-2230) 33233 at 2123 by Robin Clark; RHC Havana via USSR 11.705 (Fr, Eng 2100-2300) 44444 at 2110 by Robin Harvey; AIR via Aligarh, India 11.620 (Eng, Hi 1845-2230) 54444 at 2220 by Ron Damp; UAE R. Dubai 11.955 (Ar, Eng) - SIO 333 at 2300 by Scott Caldwell; R. Japan via Moyabi, Gabon 11.835 (Jap, Eng 2200-0000) SIO333 at 2345 by Francis Hearne.

Some broadcasts to other areas were also logged here: R. RSA, S.Africa 11.745 (Fr to W.Africa 0400-0700), noted as 54444 at 0401 by Chris Shorten; KNLS Anchor Point, AL 11.715 (Eng to E.Asia 0800-0900) 22212 at 0800 by Sheila Hughes; WYFR via Okeechobee, FL 11.855 (Sp to S.America 0800-1100) SIO322 at 0811 by Phillip Rambaut; RBI via Wusterhausen, Germany 11.785 (Eng, Ger to Middle East 0745-0945) 52322 at 0900 by John Sadler; R. Australia via Shepparton 11.910 (Eng to SE.Asia 1100-1300) 21232 at 1246 by Jim Cash; BBC via Kranji, Singapore 11.750 (Eng to S.Asia 0900-1615) 43333 at 1554 by Alan Smith; R. Polonia, Warsaw 11.840 (Eng, Fr, Ar to W/N.Africa 1830-2025) 44433 at 2000 by Darran Taplin; RTV Tunis, Sfax 12.005 (Ar to Middle East, N.Africa 1700-2345) SIO223 at 2018 by Ted Walden-Vincent; R. Damascus, Syria 12.085 (Ar, Sp, Port to S/C.America 2215-0115) 34343 at 2220 by Cliff Stapleton; R. Kiev, Ukraine 11.790 (Uk, Eng to USA 2100-0230) 55444 at 2300 by Roy Patrick; Voice of Israel, Jerusalem 11.605 (Eng to USA 2300-?) 34443 at 2323 by David Edwardson; R. Baghdad, Iraq 11.830

Freq MHz	Station	Country	UTC	DXer
2.420	R.Sao Carlos	Brazil	0030	M,Q
3.200	Vos 1, Fuzhou	China	2230	Q
3.205	AIR Lucknow	India	1700	Q
3.215	R.Orange	S.Africa	1850	K
3.220	R.HCJB Quito	Ecuador	0245	M
3.220	R.Togo, Lome	Togo	2200	Q
3.230	R.Nepal	Kathmandu	1710	Q
3.245	R.Clube Varginha	Brazil	0100	Q
3.255	BBC via Maseru	Lesotho	0100	H,M
3.270	SWABC 1, Namibia	S.W.Africa	1827	Q
3.315	AIR Bhopal	India	0100	Q
3.315	SLBS Freetown	Sierra Leone	2230	M
3.320	R.El Sol de Los Andes	Peru	0300	Q
3.365	GBC Radio 2	Ghana	2030	E,F,K
3.395	RRI Tanjungkarang	Indonesia	2230	Q
3.905	AIR Delhi	India	1900	L
3.915	BBC Kranji	Singapore	1937	G,K,L,Q
3.955	BBC Daventry	England	1935	A,D,F,G,I,P
3.965	RFI Paris	France	1830	A,G,J,K
3.975	BBC Skelton	England	0349	A
3.980	VOA Munich	W.Germany	1830	G,K,N
3.985	R.Beijing, China	via SRI Berne	2100	G,I,J,N,P
3.985	SRI Berne	Switzerland	1755	F,H,I
4.010	R.Frunze 1	USSR	1801	H
4.220	PBS Xinjiang	China	2305	E
4.330	PBS Xinjiang	China	2305	E
4.460	R.Beijing	China	2039	J
4.470	R.Movima	Bolivia	0200	Q
4.500	Xinjiang	China	2320	E
4.650	R.Santa Ana	Bolivia	0030	Q
4.735	Xinjiang	China	2315	E
4.755	RRI Ujungpadang	Indonesia	1800	Q
4.765	Brazzaville	P.Rep.Congo	1840	G,J,K
4.770	FRCN Kaduna	Nigeria	2020	K
4.775	RRI Jakarta	Indonesia	1818	E,J
4.785	RTM Bamako	Mali	2020	K
4.790	TWR Manzini	Swaziland	1830	G,K
4.795	La Voz de los Caras	Ecuador	0100	Q
4.800	LNBS Lesotho	Maseru	1831	J,K
4.805	R.Nac.Amazonas	Brazil	2245	Q
4.810	R.Yerevan 2	USSR	1928	J
4.830	Gaborone	Botswana	1840	K
4.830	R.Tachira	Venezuela	0311	E
4.832	R.Rejo	Costa Rica	0515	E,Q
4.835	R.Tezulutlan, Coban	Guatemala	0100	E,Q
4.835	RTM Bamako	Mali	1940	I,K
4.845	RRI Ambon	Indonesia	1700	Q
4.845	ORTM Nouakchott	Mauritania	1940	K
4.850	R.Yaounde	Cameroon	2022	C,F,G,J,K,P
4.865	PBS Lanzhou	China	2052	E,K
4.865	V of Cinaruco	Colombia	0505	E,Q
4.870	R.Cotonou	Benin	2100	K
4.900	SLBC Colombo	Sri Lanka	0100	Q
4.905	R.Relogio, Rio	Brazil	2325	E
4.905	R.Nat.N'djamena	Chad	2022	G,K
4.910	R.Zambia, Lusaka	Zambia	1835	K
4.915	R.Anhanguera	Brazil	0525	E,Q
4.915	R.Ghana, Accra	Ghana	2100	K
4.915	Voice of Kenya	Kenya	1835	K
4.925	R.Nacional, Bata	Eq.Guinea	2050	K
4.930	R.Moscow	USSR	2025	G,K
4.935	Voice of Kenya	Kenya	1835	G,K
4.940	R.Kiev 2	USSR	2023	G,K
4.958	R.Baku	USSR	1835	G,K
4.970	R.Rumbos, Caracas	Venezuela	0458	E
4.975	R.Uganda, Kampala	Uganda	2034	K
4.990	FRCN Lagos	Nigeria	2026	B,G,K
5.030	R.Catolica, Quito	Ecuador	0130	Q
5.035	R.Bangui	C.Africa	2105	G
5.040	R.Maturin	Venezuela	0300	Q
5.047	R.Togo, Lome	Togo	2025	K
5.050	SBC Singapore	Singapore	2256	E,M
5.065	R.Candip, Bunia	Zaire	1840	G,K
5.075	Caracol Bogota	Colombia	0520	E
5.260	R.Alma Ata 2	USSR	1907	B
5.661	R.La voz de Cutervo	Peru	0240	Q

**DXers:**

- A: Ted Agombar, Norwich.
- B: Thomas Barnett, Slough.
- C: Leo Barr, Sunderland.
- D: Donald Blashill, Cheltenham.
- E: David Edwardson, Walsend.
- F: Bill Griffith, La Clusaz, Fr Alps.
- G: Sheila Hughes, Morden.
- H: Rhoderick Illman, Thumrait, Oman.
- I: Eddie McKeown, Co.Down.
- J: John Nash, Brighton.
- K: Fred Pallant, Storrington.
- L: John Parry, Northwich.
- M: Tim Shirley, Bristol.
- N: Chris Shorten, Norwich.
- O: Alan Smith, Northampton.
- P: Cliff Stapleton, Torquay.
- Q: Jim Willett, Knock Fell, Cumbria.

(Eng, Ar to USA 0130-0630), heard at 0130 by **Simon Holland** in Douglas, IOM.

The **9MHz (31m)** broadcasts to Pacific areas from R. New Zealand Int, Wellington on 9.855 (Eng 0710-0830 Mon-Fri, 0645-1100 Sat) have been reaching the UK. Whilst monitoring them on a daily basis, Cyril Kellam has found reception to be quite good during most mornings.

The many 31m broadcasts to Europe include WMLK Bethal, USA 9.465 (Eng 0400-0700), rated 23143 at 0600 by Eddie McKeown; Voice of the Mediterranean, Malta 9.765 (Eng, Ar 0600-0800) 43343 at 0633 by Robin Harvey; WHRI South Bend, USA 9.620 (Eng 0600-0800) 55545 at 0635 by Harold Wood; R. HCJB Quito, Ecuador 9.610 (Eng 0700-0800) 44444 at 0710 by Robin Clark; WCSN Scotts Corner, Maine 9.840 (Eng 0600-1000) 44333 at 0735 by Ron Damp; BBC via Daventry, UK 9.410 (Eng 0200-0915) 44444 at 0800 by Ted Agombar; R. Finland via Pori 9.550 (Fin, Ger, Eng, Fr, Sw 1600-2055) 44444 at 1845 by

Ted Gould; Voice of Turkey, Ankara 9.460 (Tur 1600-2155), noted as 'good' by **Arman Samanci** in Stockton-on-Tees; R. Cairo, Egypt 9.900 (It, Ger, Fr, Eng 1800-2245), heard by **Julian Wood** in Elgin; VOIRI Tehran, Iran 9.022 (Russ, Fa, Tur, Ger, Fr, Eng, Sp, Ar 1530-2230) 43453 at 2010 by John Parry; Voice of Vietnam, Hanoi 9.840 (Eng, Russ, Viet, Fr, Sp 1600-2130) 43433 at 2040 by Darren Beasley; Vatican Radio, Rome 9.645 (Hung, Cz, Pol, Ger, It, Fr, Eng, Sp, Port, Ar 1715-2100) SIO444 at 2100 by Scott Caldwell; R. Sweden, Stockholm 9.655 (Sw, Fr, Ger, Eng, Sp 1900-2200, also to Africa) SIO555 at 2100 by John Sadler; R. Beijing, China 9.920 (Ger, Eng 1800-2155) 43434 at 2100 by Cliff Stapleton; R. Pyongyang, N.Korea 9.345 (Sp, Ger, Eng, Fr 1800-2150) 55555 at 2122 by John Nash; R. Cairo, Egypt 9.900 (It, Ger, Fr, Eng 1800-2245) 44433 at 2139 by Darran Taplin.

Some long distance transmissions to Europe were noted in the **7MHz (41m)** band: WYFR via

**Transatlantic DX Chart**

Freq kHz	Station	Location	Time	DXer
<b>USA</b>				
570	WMCA	New York, NY	0313	B
660	WFAN	New York, NY	0145	C
770	WABC	New York, NY	0230	A
890	WLS	Chicago, IL	0230	C
1010	WINS	New York, NY	2330	A,C
1190	WOWO	Ft.Wayne, IN	0347	B
1390	WCSC	Charleston, SC	0319	B
1390	WQOT	Burlington, VT	0343	B
1390	WEED	Rocky Mount, NC	0305	B
1390	WFBL	Syracuse, NY	0315	B
1390	WFMJ	Youngstown, OH	0306	B
1390	WGCI	Chicago, IL	0300	B
1390	WLAN	Lancaster, PA	0342	B
1410	WPOP	Hartford, CT	0200	C
1440	WFTQ	Worcester, MA	0217	B
1440	WGIG	Brunswick, GA	0313	B
1470	WJDY	Salisbury, MD	0230	B
1530	WCKY	Cincinnati, OH	0230	C
1560	WQXR	New York, NY	0430	A
1580	KNIX	Tempe, AZ	0155	C
<b>Canada</b>				
550	CFNB	Fredericton, NB	0200	A
600	CFCF	Montreal, PQ	0419	B
680	CFTR	Toronto, ON	0330	B
680	CIYQ	Grand Falls, NF	0010	C
740	CHCM	Marystown, NF	?	B
930	CJYQ	St.John's, NF	2330	C
1200	CFGO	Ottawa, ON	0346	B
1380	CKLC	Kingston, ON	0227	B
1400	CBG	Gander, NF	2300	C
1400	CJFP	Riviere-du-Loop, PQ	0120	C
1410	CFMB	Montreal, PQ	0344	B
<b>C.America &amp; Caribbean</b>				
1390	XERUY R.Univers'd	Merida, Mexico	0400	B
1470	CMDP R.C'dad	Bandera,Cuba	0258	B
1570	YSCZ Cadena Cus'n	El Salvador	0200	B
1570	Atlantic Beacon	Turks & Caicos IIs	0400	A
1610	Caribbean Beacon	The Valley,Anguilla	0500	A
<b>South America</b>				
850	R.Carve	Montevideo,Uruguay	?	C
950	R.Vision	Caracas, Venezuela	?	C
1210	QAX2Q R.Universo	Tujillo, Peru	0258	B
1260	R.Globo	Rio, Brazil	0330	A
1260	R.Muhler	Sao Paulo, Brazil	?	C
1350	R.Cristal	Salvador, Brazil	?	C
1380	H.JLG LaVoz Dorada	Colombia	0330	B
1380	QAX2W R.Atahualpa,	Peru	0200	B
1470	QAX4D R.Huancayo	Peru	0234	B
1470	QAX6M R.Tacna	Peru	0300	B
1470	VVJW R.Latina	Valencia, Venezuela	0130	B
1520	R.Bonita	Guatre, Venezuela	?	C

- DXers:**  
A: Tim Shirley, Bristol.  
B: Derek Taylor, Preston.  
C: Jim Willett, Knock Fell, Cumbria.

**184 PAGES  
PACKED WITH  
COMPONENTS,  
KITS, TEST  
EQUIPMENT  
AND BOOKS...**

**BATTERIES**

Ni-cad, Dry Cell, Ni-cad Chargers, Eliminators, Holders, Connections

**BOOKS**

General, Textbook and Basics, Radio and TV, Data/Reference, Projects/DIY, Measurement/Servicing, Linear Electronics, Audio, Digital Electronics, Computers

**CABLE AND WIRE**

Equipment Wire, Mains Cable, RF Cable, Audio Cables, Ribbon Cable, Enamelled Copper Wire, Accessories

**CAPACITORS**

Electrolytic, Ceramic, Foil, Variable, Trimmers

**COMPONENT PACKS**

**COMPUTERS**

Amstrad 464/6128 Peripherals, Software, Computer Leads, Cable Adapters/Testers, Data Switches, PC Cards, Microcomputing Kits/Modules, Accessories

**CONNECTORS**

Audio, Servo, DC, RF, RF Adapters, IEC Mains, 13A Mains, Low Current, Terminal Blocks, PCB Ribbon, IDC Edge, 0.1" Pitch Edge, IC Sockets, Waterproof Sockets

**COUNTERS AND TIMERS**

LCD Modules Stopwatch

**CRYSTALS**

Crystals, Ceramic Resonators

**FILTERS**

Ceramic, Pilot Tone/and Birdie, LC Video Block, Helical, Crystal, Ceramic, RF Interference

**HARDWARE**

Equipment Cases, Aluminium Boxes, Plastic Boxes, Mounting Accessories, Knobs, Breadboards, Fuses, Fuseholders, Heatsinks, DC Fans

**INDUCTORS**

Toko Coils, Fixed Inductors, Axial RF Chokes, Surface Mount Inductors, Moulded VHF Coils, Ferrite Materials, Dust Iron Toroids

**KITS AND MODULES**

FM Tuner Sets, FM IF Amplifiers, Digital Frequency Meters, TV and Video Systems, Aerial Amplifiers, AM Systems, HF Amplifiers, Signal Processors, 6m Systems, VHF Systems, Satellite Systems, UHF Systems, Audio Amplifiers, Audio Accessories, Cassette Systems, Home and Hobby, Radio Control Systems, RF Test Equipment,

**"YOU NEVER  
KNEW THERE  
WAS SO  
MUCH IN IT"**



**THE NEW WINTER  
90/91 CATALOGUE  
OUT NOW**

**FREE!**

**25W SOLDERING IRON  
WORTH £5.98**

**WHEN YOU SUBSCRIBE  
TO THIS AND THE NEXT TWO  
ISSUES - FOR ONLY £5.00.**

**SIMPLY FILL IN THE  
COUPON AND KEEP  
UP TO DATE!**

Signal Generators and Detectors, Time and Frequency Standards, Logic Probes, Digital Meters, Power Supplies, LCD Modules

**METERS**

Moving Coil

**PCBs & EQUIPMENT**

Prototyping Systems, Artwork Materials

**RELAYS**

Coaxial, PCB

**RESISTORS**

Carbon Film, Presets, Rotary Pots, Slide Pots, Multiturn Pots, Precision Pots

**RIGS AND RECEIVERS**

2m Systems, High Power

HF ATUs, Accessories,

Scanning Receivers

**SEMICONDUCTORS**

4000 Series CMOS Devices, 74HC Series, 74LS Series TTL, Linear ICs,

Prescalers ICs, Microprocessors

Memories, Transistors, Diodes

Regulators and Power Control ICs,

Schottky Diode Balanced Mixers,

LEDs, Mounted LEDs, Infra Red LEDs,

7 Segment LED Displays, Neon and

Signal Lamps

**SPEAKERS/SOUNDERS**

Piezo Buzzers, Headphones,

Loudspeakers, Microphones

**SWITCHES**

Key, DIL, Push Button, Contact,

Code, Rotary

**TEST EQUIPMENT**

Oscilloscopes, Frequency Meters, Signal

Generators, AF and RF Generators,

Analogue Multimeters, Digital

Multimeters, Multimeter Accessories,

RF Power Measurement, Digital

Thermometers, Logic Probe and Pulsers,

DC Power Supplies, LCR Meters,

Oscilloscope Probes, Test Leads,

Calculators

**TOOLS**

Soldering Irons, Soldering accessories,

Drills and accessories, Screwdrivers,

General Tools, Static Protection,

Service Aids

**TRANSFORMERS**

PCB Mounting, Chassis Mounting

- AVAILABLE FROM LARGER NEWSAGENTS OR DIRECT FROM CIRKIT
- £10 WORTH OF DISCOUNT VOUCHERS
- LOW COST MULTIMETERS
- MANY NEW PRODUCTS

**Cirkit**

**Cirkit Distribution Ltd**  
Park Lane, Broxbourne, Herts EN10 7NQ  
(0992) 444111



**Please supply:**

- Winter '90/91 Catalogue @ £1.60
- Winter '90/91 Catalogue and subscription to the next two issues @ £5.00

I enclose Cheque/Postal Order for \_\_\_\_\_

Please debit my Access/Visa card for \_\_\_\_\_

NAME: \_\_\_\_\_

ADDRESS: \_\_\_\_\_

POST CODE \_\_\_\_\_

ACCESS OR VISA

EXPIRY DATE: \_\_\_\_\_

SIGNATURE: \_\_\_\_\_ DATE: \_\_\_\_\_

**G2VF LOOP ANTENNAS WITH ATU FOR HF HAM BAND TRANSMISSION** (SWR One to One 40, 15 and 10 One Point Five to One 80 and 20) **AND SWLS LONG AND MEDIUM WAVE FOR BCLs.** Loops 21 inches square or triangle. No special skills required. Circuits, Parts Lists sources of supply assembly data. **HIGH FREQUENCY LOOP 80 to 10Metres £5. LONG AND MEDIUM WAVE LOOP FOR BCLs £3. LONG MEDIUM SHORT WAVE LOOP 1500 to 10 METRES FOR BCL SWL £8. SHORT WAVE ATU LOOP OR LONG WIRE £4. PRE AMP LW MW S WAVE £2. PHOTO COPY HRO MANUAL £4. MW LOOP WITH PRE AMP ATU £3. PRE AMP FOR G2VF HF LOOP OR ATU £4. SHORT WAVE ATU BUILT-IN PRE AMP FOR LOOP OR LONG WIRE £7. SAE details. All projects D.I.Y. METAL DETECTOR £2. F. G. Rylands, 39 Parkside Avenue, Millbrook, Southampton SO1 9AF. Tel: (0703) 775064.**

PLEASE MENTION SHORT WAVE  
MAGAZINE WHEN REPLYING TO  
ADVERTISEMENTS



**MONITORING THE IRAQ/KUWAIT CONFLICT**

Hear the inflight conversations between the fighters, ship to shore calls, the US Navy, Military and the rest of the confrontation. The book shows where to find the action, saving hours of scanning SW bands, has many frequency lists, much detailed information and covers a lot more.

*You will be in the front line of the action!*

Price £3.95 + 50p UK P&P. Overseas, EEC & sea post 75p or £1 airmail.

INTERBOOKS, IK1, 8 Abbot Street, Perth, PH2 0EB, Scotland. Tel: (0738) 30707.

**ALL VALVES & TRANSISTORS**

Call or phone for a most courteous quotation  
**081-743 0899**

We are one of the largest stockists of valves etc, in the U.K.

COLOMOR ELECTRONICS LTD. 170 GOLDHAWK ROAD LONDON W12 8HJ

**ALYNTRONICS**

129 CHILLINGHAM ROAD, HEATON, NEWCASTLE-UPON-TYNE NE6 5XL TEL: 091-2761002

THE ONLY AUTHORISED DEALER IN THE NORTH-EAST FOR

**ICOM & YAESU**

WE ALSO STOCK MANY OTHER ITEMS OF EQUIPMENT FROM

MFJ ★ BUTTERNUT ★ CUSHCRAFT TONNA ★ DIAMOND★ AOR  
BEARCAT ★ FAIRMATE ★ JUPITER ★ LOWE ★ TEAM  
MIDLAND ★ NEVADA ★ CTE ★ WELZ  
★ REVEX ★ BOOKS & MAPS ★



LICENSED CREDIT BROKER

OPEN 10am - 5.45pm TUES - FRI 10am - 4.45pm SAT

**S.E.M.**

UNIT C, UNION MILLS, ISLE OF MAN

Tel. Marown (0624) 851277

**QRM ELIMINATOR**

A unique design, which has revolutionised interference suppression. Connects in your aerial lead and phases out interference before it gets to your receiver. Any sort of QRM, it can be next to your RX (your computer?) or several miles away, e.g. power lines, 1.5-30MHz. **£79.50.** Ex-stock.

**S.E.M. VHF CONVERTER**

Plugs into any h.f. receiver aerial socket to give you coverage from 118 to 146MHz. Tune your receiver from 2 to 30MHz. **£65.00.** Ex-Stock

**S.E.M. HF CONVERTER**

Plugs into your v.h.f. scanner aerial socket and converts its range to cover 100kHz to 60MHz. Gives you full l.f., m.f., h.f., v.h.f., u.h.f. coverage. **£55.00.**

**VERY WIDE BAND PRE-AMPS**

3MHz to 500MHz, 9dB gain, 1.5dB N.F. and unprecedented performance. Basic Pre-Amp **£37.00.** Switched through when OFF **£42** from stock.

**AUDIO MULTIFILTER**

Gives variable selectivity 3kHz-20Hz, passband tuning, Hi or Lo pass filters and 2 notch filters. They say this is the best filter anywhere. **£75** from stock.

If you require more information on our products, ring or write.  
Prices include VAT and delivery.  
C.W.O. or CREDIT CARD by phone.

**LINK ELECTRONICS**  
THE MAJOR RETAILER OF  
**REALISTIC SCANNERS**  
**NEW SCANNERS!**

**NEW PRO 2006: WITH HYPERSCAN**

400 Memories AM/FM 25-520, 760-1300MHz, 240VAC/12VDC  
★ £299.95 ★

**PRO 2005: AM/FM 25-520, 760-1300MHz**

400 Memories 240VAC/12VDC

★ ONLY! £275 while stocks last! ★

**PRO 2022: 68-88, 108-136 (AM), 136-174**

380-512, 806-960MHz 200 Memories 240VAC/12VDC

★ ONLY! £179.95 ★ List price £239.95 ★

**PRO 2024: 68-88, 108-136 (AM), 136-174**

380-512MHz, 60 Memories 240VAC (12VDC on request)

★ ONLY! £149.95 ★ List price £179.95 ★

**NEW PRO 2025: SUPERB COMPACT MOBILE**

16 Memories, 68-88, 136-174, 406-512MHz

★ £99.95 ★

**PRO 34 Handheld: 68-88, 108-136 (AM), 136-174**

380-512, 806-960MHz 200 Memories

★ ONLY! £219.95 ★ List price £249.95 ★

All Scanners Include FREE P&P in the UK. 12 months warranty

**Link Electronics**

(Authorised Tandy Dealer)

228 Lincoln Road, Peterborough PE1 2NE  
(0733-345731) SAE for leaflet.  
Phone for latest on secondhand bargains



Short Wave Receivers & Scanners



Aerial  
Accessories & Masts

**ELLIOTT ELECTRONICS**

for the Radio Enthusiast



Instant finance available  
Written details on request.



RIGS, ANTENNAS, SWR BRIDGES,  
POWER SUPPLIES, TEST GEAR,  
COMPONENTS, MORSE KEYS,  
COAXIAL CABLES, ROTATORS,  
MICS, PLUGS AND SOCKETS,  
SWITCHES.



**Books for radio amateurs**

FAMOUS "Complete Guide to VHF/UHF Frequencies 28-2250MHz"

**JAYBEAM AMATEUR ANTENNAS**  
APPOINTED DISTRIBUTOR



QSY  
OLD  
MAN TO

Call us on LEIC. 553293  
OR COME AND LOOK AROUND  
AT

26/28 Braunstone Gate,  
Leicester.

# SEEN & HEARD

## Medium Wave DX Chart

Freq kHz	Station	Country	Power kW	DXer	Freq kHz	Station	Country	Power kW	DXer
531	Ain Beida	Algeria	600	J*	990	BBC-Redmoss	UK	1	L
531	Torshavn	Faroe Is	5	H	999	R Popular, Madrid	Spain	20	C*
531	Leipzig	Germany (E)	100	E*, F*	1008	Hilversum-5 Flevo	Holland	400	F, J, M, P, U
531	Oviedo	Spain	10	F*, J*, D*	1017	SWF Wolfsburg	Germany (W)	600	C*, F*, R*, U
540	BRT-2 Wavre	Belgium	150/50	B, F*, J*, M, U	1026	Graz-Dobl	Austria	100	F*
549	Les Trembles	Algeria	600	J*	1044	DDR-1 Burg	Germany (E)	250	F*
549	DLF Bayreuth	Germany (W)	200	B, F, J*, M, U	1053	BBC-R1 Stagshaw	UK	50	M
558	Espoo	Finland	100	O*	1062	Kalundborg	Denmark	250	F*, J*
558	Valencia	Spain	20	F*, Q*	1071	Brest	France	20	F, M
567	West Berlin	Germany (W)	100	F*	1080	Palma de Mallorca	Spain	5	F*
567	RTE-1 Tullamore	Ireland (S)	500	B, D, E*, F*, M, R*, U	1089	BBC-R1 Moors de E.	UK	150	M
576	Stuttgart	Germany (W)	500	F*	1098	Bratislava	Czech	750	F*
585	FIP Paris	France	8	M	1107	RNE-5 Barcelona	Spain	20	C*, F*
585	RNE-1 Madrid	Spain	200	F*, J*	1125	La Louviere	Belgium	20	C*, M
594	HRF Frankfurt	Germany (W)	400	E*, F*, M	1134	Valencia	Spain	10	L*, V*
603	Sevilla	Spain	20	F*, F*	1134	Zadar	Yugoslavia	1200	F*, N*
603	BBC-R4 Newcastle	UK	2	F*	1143	AFN via Stuttgart	Germany (W)	10	E, V
612	RTE-2 Athlone	Ireland (S)	100	E*, F*, J*, D	1143	Century R Dublin	Ireland (S)	?	E, V
621	RTBF-1 Wavre	Belgium	80	B, F, M, U	1143	Kaliningrad	USSR	150	C*, F*, J*
621	Barcelona	Spain	10	F*, J*	1152	RNE-5 Zamora	Spain	5	C*
630	Vigra	Norway	100	F*	1179	SER Murcia	Spain	5	F*, V*
639	BBC Limmasol	Cyprus	500	H*	1179	Solvesborg	Sweden	600	F*, V*
639	Liblice	Czech	1500	J*	1188	Kuurne	Belgium	5	M
639	La Coruna	Spain	100	F*, J*	1188	Szolnok	Hungary	135	F*
648	Palma de Mallorca	Spain	100	F*, J*	1197	VDA via Munich	Germany (W)	300	F*
648	BBC Orfordness	UK	500	A*, F*, J, L, M, U	1197	BBC-R3 Bourmesth	UK	0.5	L, M, Q*
657	Burg	Germany (E)	250	C*	1206	Bordeaux	France	100	F*, Q*
657	Napoli	Italy	120	J*	1206	Wroclaw	Poland	200	F*, P*
657	BBC-R. Wales Wrx m	UK	2	E, F, J	1215	BBC-R3 M's de E.	UK	100	F*, V*
666	Bodenseesender	Germany (W)	300/180	C*, F*	1224	Vidin	Bulgaria	50	M
675	Hilversum-3 Lopic	Holland	120	B, F*, J, M, R*, U	1224	COPE Madrid	Spain	20	F*, Q*
684	RNE-1 Sevilla	Spain	250	F*, J*	1233	Melnik	Czech	400	F*, Q*
684	Beograd	Yugoslavia	2000	J*	1242	Kiev	USSR	150	F*
693	Berlin	Germany (E)	250	F*	1251	Marcali	Hungary	500	F*, U*
693	BBC-R5 Droitwich	UK	150	F, O, V	1251	Tripoli	Libya	500	U*
693	BBC-R5 Stagshaw	UK	50	M, U	1251	Huisberg	Netherlands	10	U*, V*
702	Aachen/Flensburg	Germany (W)	5	C*	1260	Valencia	Spain	20	F*
702	Zamora	Spain	5	F*, M, Q*, U	1269	Neumünster	Germany (W)	600	D*, E*, F*, U, V*
711	Rennes 1	France	300	F*, M, Q*, U	1278	RTE-2 Dublin/Cork	Ireland (S)	10	E*, F, U
720	BBC via Zakaki	Cyprus	500	H*, T*	1287	Litomysl/Liblice	Czech	300/200	F*, U
720	BBC-R4 Lots Rd	UK	0.5	F, M	1296	San Sebastian	Spain	5	F*, U, V*
729	RTE-1 Cork	Ireland (S)	10	F*, J	1296	BBC Orfordness	UK	500	F, R*, S, U, V*
729	Oviedo	Spain	50	F*	1314	Kvitsoy	Norway	1200	H*
738	Paris	France	4	M	1323	BBC Zyri	Cyprus	50	C*, E, F*, U
738	Poznan	Poland	300	P*	1323	R. Moscova v. Leipzig	Germany (E)	150	F*, Q*, U
738	RNE-1 Barcelona	Spain	250	E*, F*, J*	1332	Rome	Italy	300	E*, F*, V*
747	Hilversum-2 Flevo	Holland	400	F, J, M, R*, U	1341	BBC-Uist L. sn'g' n' v	Ireland (N)	100	F*
756	Brunswick	Germany (W)	800/200	E, F*, U	1350	Nancy/Nice	France	100	B*, F*, V*
756	Lugoj	Romania	400	U	1359	RBI Berlin	Germany (E)	250/100	F*
765	Sottens	Switzerland	500	F*, R*	1368	Manx R., Foxdale	IoM	20	E, G
783	Burg	Germany (E)	1000	E*, F*	1377	Lille	France	300	F, J, M, U
792	Sevilla	Spain	20	F*	1386	Kaunas	USSR	1000	E*, F*, U
801	BRF via Munich	Germany (W)	420	F*	1395	R. Tirana via Lushnje	Albania	1000	F*, J*, M, R*, V*
810	SER Madrid	Spain	20	F*	1395	Alicante	Spain	2	F*
810	BBC-Scot. W'st glen	UK	100	E, F*, V, X*	1404	Brest	France	20	F*, M, U
819	Batra	Egypt	450	N*	1404	Kipe	Guinea	100	W*
828	NDR Hannover	Germany (W)	100/5	M	1413	BBC via Masirah Is	Oman	1500	H*
837	Nancy	France	200	M	1413	RCE Zaragoza	Spain	20	F*, Q*
837	Shiraz	Iran	400	K*	1422	Heusweiler	Germany (W)	1200/600	E, F*, M
846	Rome	Italy	540	F*, Q*, U	1431	Dresden	Germany (E)	250	F*, M
855	RAIS Berlin	Germany (W)	100	F*	1440	Marnach	Luxembourg	1200	B*, C*, F*, M, R*, V*
855	Murcia	Spain	125	F*, Q*	1458	R. Tirana, Lushnje	Albania	500	E*
864	Paris	France	300	F, M, V	1467	TWR Monte Carlo	Monaco	1000/400	E*, F*, J*, L*, V*
873	AFN Frankfurt	Germany (W)	150	E*, F*, D*, R*, U	1476	Wien-Bisamberg	Austria	600	F*
882	BBC-Wales W'sh'rd	UK	70	F*, J, M, V	1485	BBC-R4 Carlisle	UK	1	V
891	Algiers	Algeria	600/300	F*, R*, U	1494	Leningrad	USSR	1000	F*
900	Milan	Italy	600	F*, Q*	1503	Stargard	Poland	300	F*, P*
909	R. Palma d' Mallorca	Spain	10	F*	1512	BRT Wolvertem	Belgium	600	E*, F*, J*, M, P*, V*
909	BBC-R5 Br'km's PK	UK	140	D	1530	Vatican R., Rome	Italy	1500/450	A*, E*, F*, J*, Q*
909	BBC-R5 Moorside E.	UK	200	F, M	1539	DLF Mainzfling	Germany (W)	700	F*
918	R. Intercont. Madrid	Spain	20	F*	1566	Nagpur	India	1000	W*
927	BRT-1 Wolvertem	Belgium	30	F, M, V*	1566	Sarnen	Switzerland	300	F*
927	Khairpur	Pakistan	100	K*	1575	RBI via Burg	Germany (E)	250	Q*
936	Radio Bremen	Germany (W)	100	F*	1575	Genoa	Italy	50	Q*
963	Pori	Finland	600	D*, E*, F*	1584	Pamplona	Spain	2	Q*
963	Paris	France	8	M	1593	Langenberg	Germany (W)	400/800	F*, F*, R*, U, V*
972	NDR/WDR Hamburg	Germany (W)	300	E*, F*, R*, U, V*	1602	R. Dnteniente	Spain	2	F*
981	Alger	Algeria	600/300	F*, J*					
990	SER R. Bilbao	Spain	10	F*					

Note: Entries marked \* were logged during darkness. All other entries were logged during daylight or at dusk.

### DXers:

- A: Ted Agombar, Norwich.
- B: Thomas Barnett, Slough.
- C: Darren Beasley, Bridgewater.
- D: Andy Cadley, Folkestone.
- E: Scott Caldwell, Warrington.
- F: Jim Cash, Swanwick.
- G: Jason Faulkner, Leicester.
- H: Simon Hamer, New Radnor.
- I: John Hepburn, Ashington.
- J: Sheila Hughes, Morden.
- K: Roderick Illman, Thumrait, Oman.
- L: Mark Mahabar, Leicester.
- M: George Millmore, Wootton loW.
- N: Roy Patrick, Derby.
- O: Tim Shirley, Bristol.
- P: Chris Shorten, Norwich.
- Q: Alan Smith, Northampton.
- R: Cliff Stapleton, Torquay.
- S: John Stevens, while in N.Scotland.
- T: Derek Taylor, Preston.
- U: Phil Townsend, London.
- V: Paul Weston, Kettering.
- W: Jim Willett, Knock Fell, Cumbria.
- X: David Wratten, Cambridge.

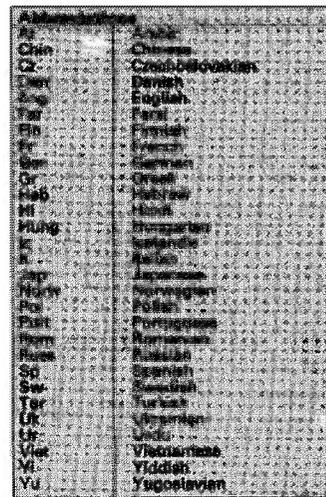

Okeechobee, Florida 7.355 (Russ, Ger, Eng 0400-0745), rated 55455 at 0450 by Chris Shorten; WHRI South Bend, USA 7.315 (Eng, Sp 0000-0600) 44444 at 0535 by Sheila Hughes; R. Australia via Carnarvon 7.240 (Eng 1700-2100) SIO444 at 1753 by Philip Rambaut; AIR via Aligarh, India 7.412 (Eng, Hi 1845-2230) 55444 at 1846 by Roy Spencer.

In the 6MHz (49m) band Ted Agombar heard the BBC via Misarah Island, Oman 5.975 at 1830 (44333); Alan Smith noted VOIRI Tehran, Iran 6.035 as 43333 at 1945; Sheila Hughes listened to King of Hope, Lebanon 6.280 at 2015 (33222).

## Equipment Used

Ted Agombar: Grundig Satellit 400 + random wire.  
 Thomas Barnett: Kenwood R-2000 + random wire.  
 Lee Carr: Matsui MR-4099 + Hives active antenna with 2m vertical wire.  
 Barry Cadley: Philips D-2935 + Hexagon loop or 40m wire.  
 Donald Caldwell: Grundig Satellit 400 + built-in whip.  
 Jim Cash: Matsui MR-4099 + single loop.  
 Keith Clark: Loew HF-225 + random wire or 40m loop.  
 Andy Cadley: Salath SW-500 + 40m wire or Delta active antenna.  
 Scott Caldwell: Seisho 2600 + random wire or Tascam RT-331 + loop.  
 Jim Cash: Kenwood R-5000 + trap dipole or Sony AM-1 active antenna.  
 Robin Clark: Seisho SW-5000 + 16m wire.  
 John Chisham: Yaesu FRG-7 + random wire.  
 Roy Damp: Racal RA17 + chimney mounted whip.  
 David Edwards: Trio R-600 + trap dipole 22m long.  
 Ted David: Sony ICF-7601L portable + built-in whip.  
 Alan Dwyer: Codar CR70 + Codar a.t.u. + Ex-Army rod antenna.  
 GHI Dwyer: Sony ICF-2002 + 16m wire.  
 Steve Hamer: Grundig 4400 + 15m wire.  
 James Harney: Matsui MR-4099 + SW whip.  
 Francis Hearne: Sharp GFA3 cassette + random wire.  
 John Harney: Selena Vega 215 portable.  
 Stuart Hebble: Sangean ATS-803A portable + built-in whip.  
 Sheila Hughes: Sony ICF-7600S portable or Panasonic DM48 + thin mounted L.  
 Mark Illman: Sony ICF-7600S + 12m wire.  
 Mark Illman: Ferguson PR-39 portable.  
 Colin Millmore: Teclun TMR-780 portable.

George Millmore: Teclun TMR-780 portable or Racal RA17 + random wire.  
 John Mahabar: Kenwood R-5000 + Hives ADS76 active antenna.  
 Lee Carr: Sony ICF-2001B + loop.  
 Barry Cadley: Trio R-2000 + random wire or 10m.  
 John Carr: Realistic DX-400 + 33m wire.  
 Roy Cash: Loew HF-125 + 20m wire.  
 Roy Cash: Home built one wire (1150) straight RX + random wire.  
 Philip Caldwell: Hit Maxima Radio R-700M + random wire.  
 Alan Dwyer: Loew HF-225 + 31m dipole.  
 John Sedler: DX-400 or Omega 630 + a.t.u. + SW Loop.  
 James Harney: Matsui MR-4099 portable.  
 Alan Smith: Matsui MR-4099 + Mitsuo KK-3 a.t.u. + vertical dipole.  
 Roy Spencer: Realistic DX-400 + a.t.u. + random wire.  
 Cliff Stapleton: Philips D-2935 or Trio R-1000 + dipole or 25m wire.  
 John Stevens: Hammarlund HD-180 or Loew HF-75 + random wire.  
 Derek Taylor: Loew HF-225 or Delta active antenna + Global 1000 + 20m wire.  
 Ted Agombar: Sony ICF-2001D + 1.7m loop or large LWP outdoor loop.  
 Phil Townsend: Loew SRX-30 + loop or a.t.u. + random wire.  
 David Wratten: Teclun Grundig Satellit 14900L.  
 Paul Weston: Toshiba RT-8057 rod mounted whip.  
 Neil Whittington: Sangean ATS-803A portable + built-in whip.  
 Jim Willett: Trio SR690S or Yaesu FRG-7800 + 20m wire or Delta loop.  
 Jim Willett: Philips D-2935 + 17m wire.  
 John Weston: Trio R-2000 + Yaesu FRT-7700 a.t.u. + SW wire.  
 David Wratten: Philips D-2935 + m.w. loop.

## NEW!! FAX FOR YOUR SPECTRUM

Receive FAX pictures on your Spectrum,  
weather maps, etc.

This is the one that **does** display on the screen as well as  
allowing a dump to a printer.

The programme needs an external drum speed generator.  
**PROGRAMME ONLY £12.00. DRUM SPEED GENERATOR £28.00**

**Now receives various speed transmissions.**

Upgrade available to existing users. Details on request.

### J. & P. ELECTRONICS LTD.

VISA

Unit 45, Meadowmill Estate, Dixon Street,  
Kidderminster DY10 1HH Tel: (0562)753893



## AVIATION ENTHUSIASTS AVIATORS - LISTENERS

AIR TRAFFIC CONTROLLERS - on  
hand to help 'Guide' you towards an  
interesting & rewarding pastime.  
AIR BAND RADIOS-SCANNERS etc.  
Over 20 to choose from: AERIALS &  
ACCESSORIES: MAPS - BOOKS:  
CHARTS: CAA PUBLICATIONS:  
POSTCARDS: MODELS: TIE PINS &  
BADGES: AIRBAND TRANSCEIVERS:  
PHOTOS: PILOTS PRODUCTS

Information pack only **50p.**

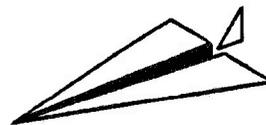

### AIR SUPPLY

**83b High Street, Yeadon,  
Leeds LS19 7TA. TEL: 0532-509581**  
Shop just two minutes from Leeds Bradford Airport.  
(Closed Wednesday & Sunday).

**YAESU FRG8800 & FRG9600 CONTROL SOFTWARE FOR IBM PC.**  
PC-MONITOR Professional controls Frequency, Mode, Scanning and Memory storage from the  
keyboard of your IBM PC (or compatible).  
\* 10 selectable tuning steps \* Auto/manual memory scanning \* Comprehensive logbook  
facility \* Supports FRG8800 VHF/FM options \* Supports FRG9600 Frequency extension \* 1000  
memory channels \* VFO A/B per channel \* Bandplan data display \* Supports mouse control  
\* Supports Mono or Colour.  
Requires RS232 port and Yaesu FIF232 or similar. Optional Bargraph AGC display and Spectrum  
Analysis, with additional hardware. Software (5.25 or 3.5) plus 40 page Manual £41.50. A4 SASE  
for details to: **B.J. Jenkins, 32 Marsh Crescent, High Halstow, Kent ME3 8TJ.**

**The Vintage Wireless Book Listing** Published regularly containing 100s of out of print old and  
collectable Wireless, T.V. and Amateur Radio books/mags. etc. Send three 1st class stamps for next  
issue or £1.75 for next 4 issues. **WANTED** Pre 1960 Wireless, Amateur Radio and T.V. Books and  
Magazines. **NEW PUBLICATIONS** **The Government Surplus Wireless Equipment Handbook.**  
Facsimile reprint. Gives detailed information and circuit diagrams plus photos for British and  
American surplus receivers, transmitters, and test equipment. Large format. Incorporated is a surplus/  
commercial cross referenced valve and transistor guide. Price £12.50 inc. Postage. **The H.F. BAND  
FREQUENCY LIST.** This huge volume covers the H.F. Spectrum from 2-30 MHz and gives details of  
transmissions outside the amateur bands includes details of Marine, Air, Military, Embassy, Press and  
News Agencies, Time Schedules plus comprehensive RTTY details. Price £7.50 incl. postage.  
**CHEVET BOOKS (Dept SW) 157 Dickson Road, Blackpool FY1 2EU Tel: (0253) 751858.**

#### SPECIAL NOTICE TO READERS

Although the Proprietors and staff of *Short Wave Magazine* take all reasonable precautions to protect the interests of readers by ensuring as far as practicable  
that advertisements in *Short Wave Magazine* are *bona fide*, the magazine and its Publishers cannot give any undertakings in respect of claims made by  
advertisers, whether these advertisements are printed as part of the magazine, or are in the form of inserts.  
While the Publishers will give whatever assistance they can to readers having complaints, under no circumstances will the magazine accept liability for non-  
receipt of goods ordered, or for late delivery, or for faults in manufacture. Legal remedies are available in respect of these circumstances, and readers who have  
complaints should address them to the advertiser or should consult a local Trading Standards Office, a Citizen's Advice Bureau, or their own solicitor.

### INDEX TO ADVERTISERS

Aerial Techniques .....	46	Comar .....	46	Interbooks .....	58	Photo Acoustics .....	35
Aerotronic Controls .....	42	Datong .....	28	J. & P. Electronics .....	60	Rapid Results College .....	49
Air Supply .....	60	Dewsbury Electronics .....	36	Javiation .....	42	Raycom .....	27
Alyntronics .....	58	Dressler Communications .....	41	Jenkins. B .....	60	Rylands F G .....	58
ARE .....	13	Elliott Electronics .....	58	Johnsons Shortwave Radio .....	42	S E M .....	58
ASK Electronics .....	22	Euro AM .....	42	Klingenfuss Publications .....	49	SRP Trading .....	21
BBC .....	14	EMP .....	28	Lake Electronics .....	46	Solid State Electronics .....	14
Beckett. P .....	49	ERA .....	45	Link Electronics .....	58	South Midlands Communications ...	
Bredhurst Electronics .....	41	Flightdeck .....	46	Lowe Electronics .....	8, 9, 29	..... Cover iv	
Camden Mini Steam .....	63	Hoka Electronics .....	50	Marco Trading .....	14	Spacetech .....	63
Chevet Books .....	60	Holdings Amateur .....	49	Medium Wave Listeners .....	42	Stephens James .....	53
Circuit .....	57	Howes. CM Communications .....	43	Nevada Communications .....		Technical Software .....	63
City Satellite .....	50	ICS Electronics .....	48, 54	..... Cover ii, 16, 17		Ward Reg & Co .....	53
Colomor Electronics .....	58	Icom (UK) .....	Cover iii	Phase Track .....	45	Waters & Stanton .....	24

**PUBLISHED** on the fourth Thursday of each month by PW Publishing Ltd., Enefco House, The Quay, Poole, Dorset BH15 1PP. Printed in England by KSC Printers Ltd, Tunbridge Wells, Kent. Distributed by Seymour, Windsor House, 1270 London Road, Norbury, London SW16 4DH, Tel. 01-679 1899, Fax: 01-679 8907, Telex: 8812945. Sole Agents for Australia and New Zealand - Gordon and Gatch (Asia) Ltd., South Africa - Central News Agency Ltd. Subscriptions INLAND £19.00, EUROPE £21, OVERSEAS (by ASP) £22, payable to SHORT WAVE MAGAZINE, Subscription Department, PW Publishing Ltd., Enefco House, The Quay, Poole, Dorset BH15 1PP. SHORT WAVE MAGAZINE is sold subject to the following conditions, namely that it shall not, without the written consent of the publishers first having been given, be lent, re-sold, hired out or otherwise disposed of by way of trade at more than the recommended selling price shown on the cover, and that it shall not be lent, re-sold, hired out or otherwise disposed of in a mutilated condition or in any unauthorised cover by way of Trade, or affixed to or as part of any publication or advertising, literary or pictorial matter whatsoever.

# SEEN & HEARD

## LW MARITIME RADIO BEACONS

Brian Oddy G3FEX  
Three Corners, Merryfield Way, Storrington,  
West Sussex RH20 4NS

Quite a number of the long wave maritime radiobeacons located around the coast of the UK and some other countries have been logged by newcomers to this aspect of our hobby. In Torquay, **Cliff Stapleton** tried searching for maritime radiobeacons for the first time and found it to be quite interesting. He says, "It seems a good way to learn the Morse code". Using a Trio R-1000 receiver with a random wire antenna, Cliff compiled a list of ten beacons for the chart.

Whilst searching the band in London, **Phil Townsend** found difficulty in concentrating on one beacon signal to the exclusion of any others that were present, particularly if the signal was weak. He used a long wave to 28MHz convertor ahead of his Lowe SRX-30 receiver and compared the performance of his home-built l.w. loop with that of a 10m random wire plus antennatuning unit. The best results were obtained with the 10m wire and he was very surprised to receive during daylight the beacon signal (CV) from Cabo Carvoeiro Light House, Portugal on 287.3kHz.

It is worth remembering that most of the maritime radiobeacons around our shores operate between 285 and 312.6kHz and use two letter call signs. During an initial check in Manchester, **Harold Wood** picked up the Consul beacon (LEC) in Stavanger, Norway on 319kHz, but he was unable to hear any other beacon signals. Consul is a special long-range navigational aid. The transmitted signal has four parts:

- (1) A long continuous note interrupted by the station call sign.
- (2) A short period of silence.
- (3) A keying cycle of alternate dot and dash sectors separated by an equisignal formed by the merging of the dots and dashes.
- (4) A short period of silence - the cycle is then repeated.

The great circle bearing can be obtained by merely counting the number of dots and dashes.

In Northampton, **Alan Smith** has been trying to log some of the maritime radiobeacons which operate between 312.6 and 414kHz i.e. outside the normal band. In addition to the Consul beacon (LEC) in Stavanger on 319kHz, several other beacons were heard, but they all proved to be aircraft beacons, which cannot be included in the chart. His interesting list for the chart was compiled with a Matsui MR-4099 portable - it includes the beacon (GA) on 287.3, which is located on the Outer Gabbard light vessel off Suffolk.

A careful check during daylight enabled **Ian Harling** (Eastbourne) to

### Long Wave Maritime Radiobeacon Chart

Freq	Call	Station Name	Location	DXer	Freq	Call	Station Name	Location	DXer
285.0	GY	Castle Breakwater	Channel Is	G*	301.1	NF	North Foreland LH	E.Kent	A,D,H,K,L
287.3	BY	Bressey LH	Shetland Is	B	301.1	OR	Orskaer	Sweden	F
287.3	CM	Cromer LH	Norfolk	G,L	301.1	PY	Point of Ayre LH	IDM	A*,B
287.3	CV	Cabo Carvoeiro LH	Spain	L	301.1	SR	Skerries LH	Anglesey	B,E,G
287.3	DG	Douglas Pier LH	IOM	B	301.1	SU	South Rock LV	Co.Down	B,E
287.3	FN	Walney Island	off Lancs	B	301.1	WK	Wicklow Head Light	Co.Wicklow	B
287.3	GA	Outer Gabbard LV	off Suffolk	A,B,H*,L	303.4	FB	Flamborough Hd LH	E.Yorkshire	B
287.3	LV	Udageon LV	off Norfolk	A,B,L	303.4	FF	Fife Ness Point	Fife	B
287.3	PS	Point Lynas	Anglesey	B,E,H	303.4	LJ	Longstone LH	Berwick	B,F*,G
287.3	SK	Smith's Knoll LV	off Norfolk	B,L	303.4	SJ	Souter Light	Sunderland	B
289.6	D	Rota	Spain	G*	305.7	CB	Corbiere	Jersey C.I	G*,K,L
289.6	FD	Fidra LH	F. of Forth	B	305.7	CS	Calais Main LH	N.France	D,L
289.6	FV	Falsterborev Lt	Denmark	F*	305.7	FR	Faerder LH	Norway	F*
289.6	TN	Thyboron LH	Denmark	B	305.7	FS	Fall's LV	off Kent	D,H,L
291.9	CP	St.Catherine's Pt	IOW	A,I,K,L	305.7	LS	Hirtshals	Norway	B
291.9	ER	Pointe de Ver LH	N.France	A,L	305.7	WH	West Hindar	off Belgium	A*,F*
291.9	FG	Pointe de Barfleur	N.France	A,D,I,K,L	308.0	BO	Barra Head LH	Is of Barra	B
291.9	KD	Kinnairds Head LH	Aberdeen	B,E	308.0	GL	Eagle Island LH	W.Ireland	B,G
291.9	LH	Le Havre	France	F*	308.0	HK	Texel	Germany	F*
291.9	MH	Mahon, Minorca	Balearic Is	F*	308.0	MZ	Mizen Head LH	S.Ireland	B
291.9	NR	N.Ronaldsday LH	Orkney Is	B,H	308.0	RR	Round Island LH	Nr Cornwall	B
291.9	OM	Stroma Pt LH	Caithness	B,J	308.0	SO	Oelands Soedra Udde	Sweden	F
291.9	PB	Portland Bill LH	Oorset	I	308.0	VL	Vlieland	Norway	B
291.9	SB	Sumburgh Head	Shetland Is	B	310.3	AL	Pointe d'Ailly LH	France	D,K,L
291.9	TI	Cap d'Antifer	France	A	310.3	BO	Boulogne	France	D
294.2	AH	Altacarry Head LH	Antrim	B	310.3	DU	Dungness LH	S.Kent	D,H,K
294.2	DA	Pladda LH	Is of Arran	B,E	310.3	GD	Girdle Ness	Aberdeen	B
294.2	FL	Fladen	Denmark	F*	310.3	PH	Cap d'Alprech	France	A*,C,D,H,I,K,L
294.2	HG	Holmengra LH	Norway	F*	312.6	FN	Feistein	Norway	B
294.2	LG	Eilean-Glas LH	Is of Harris	B	312.6	GU	Geltungane	Norway	B
294.2	MW	Mew Island LH	off Co.Down	B	312.6	MA	Marstein	Norway	B
294.2	OR	Oigh Sgeir LH	off Is Rum	B	312.6	PT	Souter Pt	Durham	B
294.2	PA	Cabo de Palos LH	Spain	F*	312.6	RB	Cherbourg	France	C,I,L
294.2	RN	Rinns of Islay	Is of Islay	B	312.6	UK	Sunk LV	off Essex	H
294.5	KA	Kajbolovo	USSR	F	312.6	UT	Utsira	Norway	B
294.5	MH	Mohni	USSR	F	312.6	VR	Utvaer	Norway	B
294.5	NG	Pikasaare Dts	USSR	F	313.5	PQ	Ile Porquerolles	France	F*
296.5	BH	Blaavandshuk LH	Denmark	B	318.0	BH	Berry Head LH	Devon	I
296.5	HM	Hanstholm	Denmark	B	318.5	RS	Ristna	USSR	G
296.5	KL	Skiinna	Norway	G*	319.0	LEC	Stavanger	Norway	B,H*,L,M
296.5	LA	Lista LH	S.Norway	B,L	397.2	DHE	Helgoland Lt	?	B
296.5	NK	Inchkeith	F. of Forth	B,L	412.0	AS	Aarhus LH	Denmark	F*
296.5	NP	Nieuwpoort W.Pier	Belgium	D					
298.8	AD	Ameland	Holland	B,G*					
298.8	BL	Butt of Lewis	Is of Lewis	B					
298.8	CW	Cape Wrath LH	Sutherland	B					
298.8	LK	Suie Skerry LH	off Orkney	B					
298.8	MF	Muckle Flugga LH	Shetland Is	B					
298.8	PE	Penlee Pt	UK	B					
298.8	QS	Casquets LH	Channel Is	C,I					
298.8	RO	Roches Douvres LH	Channel Is	S					
298.8	SP	Start Point LH	S.Devon	I					
301.1	CN	Cregneish	IOM	A*,B					
301.1	GE	Skarvoy Eggersund	Norway	B					
301.1	HO	Hirsholm Main LH	Denmark	B					
301.1	IB	Bardesey Is LH	N.Wales	B,F*					

Note: Entries marked \* were logged during darkness. All other entries were logged during daylight.

#### DXers:

- A: Thomas Barnett, Slough.
- B: Kenneth Buck, Edinburgh.
- C: John Coulter, Winchester.
- D: Ian Harling, Eastbourne.
- E: Simon Holland, Douglas, IoM.
- F: John Macdonald, Thurso.
- G: Tim Shirley, Bristol.
- H: Alan Smith, Northampton.
- I: Cliff Stapleton, Torquay.
- J: John Stevens, while in N.Scotland.
- K: Darran Taplin, Breconhley.
- L: Philip Townsend, London.
- M: Harold Wood, Manchester.

add four more beacons to his growing list, FG 291.9; NP 296.6; DU 310.3 and BO 310.3. He used a Panasonic DR-26 portable with just the built-in ferrite rod antenna. In Douglas, IOM **Simon Holland** added five beacons to his list: PS 289.3; KD 291.9; DA 294.2; SR 301.1 and SU 301.1. Owing to a shortage of time, **Darran Taplin** (Brenchley) could only check the band once, but he heard the Cap d'Alprech beacon (PH) on 310.3 for the first time. It was also heard for the first time by **John Coulter**, who used a Yaesu FRG-7 receiver plus random wire in Winchester.

The extensive log from **Kenneth Buck** in Edinburgh was compiled during daylight. He noted a general improvement in l.w. reception and logged five beacons which he had not heard before. A home-made 1 x 0.5m loop with an f.e.t. source-follower was used with either a Lowe

HF-225 receiver or a home-built t.r.f. receiver consisting of three r.f. stages, detector and a.f. amplifier.

In contrast, all of the beacons logged by **John Macdonald** in Bettyhill by Thurso were received after dark. During fourteen nights he checked the band between 2300 and 0100, but the level of static was sometimes so bad that he had to close down. He was especially pleased to log the Mahon, Minorca beacon (MH) on 291.9 as his previous attempts to reach into the Mediterranean area have been rather unsuccessful. He says, "I also uncovered a small nest of Soviet beacons croaking away - and they do croak for some reason, which makes them clearly identifiable - on 294.5".

During a holiday in northern Scotland, **John Stevens** checked the band with a small portable whilst travelling along the coast from Durness, near Cape Wrath, to

Duncansby Head. Unfortunately the set would not tune higher than 255kHz, so he could only receive the very potent signal from Stroma Lighthouse (OM) on 291.1 which is near to John O'Groats. John says, "I was impressed by the total absence of TV interference up there".

*Reed's Nautical Almanac* contains a series of maps which depict the location of the maritime radiobeacons around our shores and those of some other countries. The accompanying data indicates their exact position in longitude and latitude; their range under all conditions; the call sign used to identify them along with the Morse Code; the frequency of the radiated signal in kHz; also the duration of their operating cycle. The 1991 edition is now available from the publishers Thomas Reed, 178-185 High Street West, Sunderland, Tyne and Wear. While stocks last, they are willing to supply the 1990 edition at £5 post paid.

For the latest updates on the world of listening, ring Radioline on  
0898 654676.

calls charged at 33p per minute cheap rate, 44p per minute all other times

The books listed have been selected as being of special interest to our readers. They are supplied from our editorial address direct to your door. Some titles are overseas in origin.

## HOW TO ORDER

**POST AND PACKING:** add 65p for one book, £1.25 for two or more books, orders over £30 post and packing free. (overseas readers add £1.50 for one book, £3.00 for two or more for sea/air mail postage) and send a postal order, cheque or credit card money with your order (orders for book titles and quantities) to **PTW Publishing Limited, FREEPOST, Eneco House, The Quay, Poole, Dorset BH15 1PP.** Please make your cheque payable to Short Wave Magazine, payment by Access, Mastercard, Eurocard or Visa also accepted on telephone orders to Poole 0202 665524. Books are normally despatched by return of post but please allow 28 days for delivery. Prices correct at time of going to press. Please note: all payments must be made in Sterling.

\* A recent addition to our Book Service. O/P = Out of print, O/S = Out of stock.

### RADIO

#### AIR & METEO CODE MANUAL 10th Edition. Joerg Klingenfuss

Detailed descriptions of the World Meteorological Organisation Global Telecommunication System operating FAX and RTTY meteo stations, and its message format with decoding examples. Also detailed description of the Aeronautical Fixed Telecommunication Network amongst others. 289 pages £15.00

#### BETTER RADIO/TV RECEPTION

**A. Nallawalla, A. T. Cushman and B. D. Clark**  
An Australian book giving guidance and advice to listeners seeking reliable reception of distant radio stations, and to DX listening hobbyists. 134 pages. £9.95

#### PASSPORT TO WORLD BAND RADIO 1991

This book gives you the information to explore and enjoy the world of broadcast band listening. It includes features on different international radio stations, receiver reviews and advice as well as the hours and languages of broadcast stations by frequency. 398 pages. 13.95

#### SCANNERS (Third Edition)

**Peter Rouse GU1DKD**  
A guide for users of scanning receivers, covering hardware, antennas, accessories, frequency allocations and operating procedures. 245 pages. £8.95

#### SCANNERS 2

**Peter Rouse GU1DKD**  
The companion to Scanners, this provides even more information on the use of the v.h.f. and u.h.f. communications band and gives constructional details for accessories to improve the performance of scanning equipment. 216 pages. £9.95

#### SHORT WAVE RADIO LISTENERS' HANDBOOK

**Arthur Miller**  
In easy-to-read and non-technical language, the author guides the reader through the mysteries of amateur, broadcast and CB transmissions. 207 pages. £7.95

#### RADIOTELETYPE CODE MANUAL

**10th Edition. Joerg Klingenfuss**  
This book gives detailed descriptions of the characteristics of telegraph transmission on short waves, with all commercial modulation types including voice frequency telegraphy and comprehensive information on all RTTY systems and c.w. alphabets. 56 pages. £8.00

#### THE SATELLITE EXPERIMENTER'S HANDBOOK (USA)

A guide to understanding and using amateur radio, weather and TV broadcast satellites. 207 pages. £7.50

#### 1934 OFFICIAL SHORT WAVE RADIO MANUAL

**Edited by Hugo Gernsback**  
A fascinating reprint from a bygone age with a directory of all 1934 s.w. receivers, servicing information, constructional projects, circuits and ideas on building vintage sets with modern parts. 260 pages. £10.15

#### HIGH POWER WIRELESS EQUIPMENT

**Articles from Practical Electricity 1910-11**  
**Edited by Henry Walter Young**  
A reprint of interesting practical articles from the early days of radio. 99 pages. £6.85

### BEGINNERS

#### AN INTRODUCTION TO RADIO DXING (BP91)

**R. A. Penfold**  
How to find a particular station, country or type of broadcast and to receive it as clearly as possible. 112 pages. £1.95

#### BEGINNER'S GUIDE TO RADIO

**9th Edition. Gordon J. King**  
Radio signals, transmitters, receivers, antennas, components, valves and semiconductors, CB and amateur radio are all dealt with here. 266 pages. £7.95

#### ELECTRONICS SIMPLIFIED - CRYSTAL SET CONSTRUCTION (BP92). F. A. Wilson

Especially written for those who wish to take part in basic radio building. All the sets in the book are old designs updated with modern components. 72 pages. £1.75

#### THE SIMPLE ELECTRONICS CIRCUIT AND COMPONENTS Book One (BP62)

The aim of this book is to provide an in-expensive but comprehensive introduction to modern electronics. 209 pages. £3.50

### TELEVISION

#### THE ATV COMPENDIUM

**Mike Wooding G6IQM**  
This book is for those interested in amateur television, particularly the home construction aspect. There is not a 70cm section as the author felt this is covered in other books. Other fields, such as 3cm TV, are covered in depth. A must for the practical ATV enthusiast. 104 pages. £3.00

#### AN INTRODUCTION TO SATELLITE TELEVISION (BP195)

**F. A. Wilson**  
Answers all kinds of questions about satellite television. For the beginner thinking about hiring or purchasing a satellite TV system there are details to help you along. For the engineer there are technical details including calculations, formulae and tables. 104 pages. £5.95

#### A TV-DXERS HANDBOOK (BP176)

**R. Bunney**  
Information on transmission standards, propagation, receivers including multi-standard, colour, satellites, antennas, photography, station identification, interference etc. Revised and updated 1986. 87 pages. £5.95

#### GUIDE TO WORLD-WIDE TELEVISION TEST CARDS

**3rd Edition. Keith Hamer & Garry Smith**  
Completely revised and expanded, this is a handy reference book for the DXTV enthusiast. Over 200 photographs of Test Cards, logos, etc., world wide. 60 pages. £4.95

#### SATELLITE TELEVISION INSTALLATION GUIDE

**2nd Edition. John Breeds**  
A practical guide to satellite television. Detailed guidelines on installing and aligning dishes based on practical experience. 56 pages. £11.95

### THEORY

#### COMMUNICATION (BP99)

**Elements of Electronics Book 5**  
**F. A. Wilson**  
Fundamentals of line, microwave, submarine, satellite, digital multiplex, radio and telephony systems are covered, without the more complicated theory or mathematics. 256 pages. £2.95

#### FILTER HANDBOOK A practical design guide

**by Stefan Niewiadomski**  
A practical book, describing the design process as applied to filters of all types. Includes practical examples and BASIC programs. 195 pages. £25.00

#### FROM ATOMS TO AMPERES

**F. A. Wilson**  
Explains in simple terms the absolute fundamentals behind electricity and electronics. 244 pages. £3.50

#### AUDIO (Elements of electronics - book 6)

**F. A. Wilson**  
This book studies sound and hearing, and examines the operation of microphones, loudspeakers, amplifiers, oscillators, and both disk and magnetic recording. Intended to give the reader a good understanding of the subject without getting involved in the more complicated theory and mathematics. 320 pages. £3.95

#### PRACTICAL ELECTRONICS CALCULATIONS AND FORMULAE (BP53)

**F. A. Wilson**  
This has been written as a workshop manual for the electronics enthusiast. There is a strong practical bias and higher mathematics have been avoided where possible. 249 pages. £3.95

#### SOLID STATE DESIGN FOR THE RADIO AMATEUR

**Wes Hayward W7ZOI and Doug DeMaw W1FB**  
Back in print by popular demand! A revised and corrected edition of this useful reference book covering all aspects of solid-state design. 256 pages. £10.95

#### The ARRL ELECTRONICS DATA BOOK

**Doug DeMaw W1FB**  
Back by popular demand, completely revised and expanded, this is a handy reference book for the r.f. designer, technician, amateur and experimenter. 280 pages. £8.95

#### A BEGINNERS GUIDE TO MODERN ELECTRONIC COMPONENTS (BP285)

**R.A. Penfold**  
This book covers a wide range of modern components. The basic functions of the components are described, but this is not a book on electronic theory and does not assume the reader has an in-depth knowledge of electronics. It is concerned with practical aspects such as colour codes, deciphering code numbers and the suitability. 164 pages. £3.95

#### EVERYDAY ELECTRONICS DATA BDDK

**Mike Towley B1**  
This book is an invaluable source of information of everyday relevance in the world of electronics. It contains not only sections which deal with the essential theory of electronic circuits, but it also deal with a wide range of practical electronic applications. 250 pages. £8.95

### LISTENING GUIDES

#### AIR BAND RADIO HANDBOOK (3rd Edition)

**David J. Smith**  
Listen to conversations between aircraft and ground control. The author, an air traffic controller, explains more about this listening hobby. 174 pages. £6.99

#### AIR TRAFFIC CONTROL

**David Adair**  
A guide to air traffic control with maps, drawings and photographs explaining how aircraft are guided through crowded airspace. 176 pages. O/P

#### DIAL SEARCH

**6th Edition. George Wilcox**  
The listener's check list and guide to European broadcasting. Covers m.w., l.w., v.h.f. and s.w., including two special maps. 54 pages. £3.95

#### FLIGHT ROUTINGS 1990

**T.T. Williams**  
Identifies the flights of airlines, schedule, charter, cargo and mail, to and from the UK and Eire and overflights between Europe and America. 104 pages. £4.95

#### GUIDE TO BROADCASTING STATIONS

**20th Edition 1989/90. Philip Darrington**  
Frequency and station data, receivers, antennas, Latin American DXing, reporting, computers in radio, etc. 240 pages. £9.95

#### GUIDE TO FACSIMILE STATIONS 10th Edition

**Joerg Klingenfuss**  
This manual is the basic reference book for everyone interested in FAX. Frequency, call sign, name of the station, ITU country/geographical symbol, technical parameters of the emission are all listed. All frequencies have been measured to the nearest 100Hz. 318 pages. £14.00

#### GUIDE TO FORMER UTILITY TRANSMISSIONS

**3rd Edition. Joerg Klingenfuss**  
Built on continuous monitoring of the radio spectrum from the sixties until the recent past. A useful summary of the former activities of utility stations providing information for the classification and identification of radio signals. 126 pages. £8.00

#### GUIDE TO UTILITY STATIONS

**8th Edition. Joerg Klingenfuss**  
This book covers the complete short wave range from 3 to 30MHz together with the adjacent frequency bands from 0 to 150kHz and from 1.6 to 3MHz. It includes details on all types of utility stations including FAX and RTTY. There are 15802 entries in the frequency list and 3123 in the alphabetical call sign list plus press services and meteorological stations. 502 pages. £19.00

#### HF OCEANIC AIRBAND COMMUNICATIONS

**3rd Edition. Bill Laver**  
HF aircraft channels by frequency and band, main ground radio stations, European R/T networks and North Atlantic control frequencies. 29 pages. £3.50

#### INTERNATIONAL RADIO STATIONS GUIDE (BP255)

Revised and updated in 1989, this book shows the site, country, frequency/wavelength and power of stations in Europe, the Near East and N. Africa, North and Latin America and the Caribbean, plus short wave stations worldwide. 128 pages. £4.95

#### MARINE UK RADIO FREQUENCY GUIDE

**Bill Laver**  
A complete guide to the UK s.w. and v.h.f. marine radio networks. Useful information, frequency listings and the World Marine Coastal Phone Stations. 62 pages. £4.95

#### NEWNES SHORT WAVE LISTENING HAND BOOK

**Joe Pritchard GU0W**  
A technical guide for all short wave listeners. Covers construction and use of sets for the s.w.l. who wants to explore the bands up to 30MHz. 288 pages. £12.95

#### THE COMPLETE VHF/UHF FREQUENCY GUIDE

**Updated 1988**  
This book gives details of frequencies from 26-2250MHz with no gaps and who uses what. Recently updated, there are chapters on equipment requirements as well as antennas, etc. 88 pages. £5.95

#### THE INTERNATIONAL VHF FM GUIDE

**7th Edition. Julian Baldwin G3UHK and Kris Partridge G8AUU**  
The latest edition of this useful book gives concise details of repeaters and beacons worldwide plus coverage maps and further information on UK repeaters. 70 pages. £8.95

#### THE POCKET GUIDE TO RTTY AND FAX STATIONS

**Bill Laver**  
A handy reference book listing RTTY and FAX stations, together with modes and other essential information. The listing is in ascending frequency order, from 1.6 to 27.1MHz. 46 pages. £2.95

#### SHORT WAVE LISTENERS CONFIDENTIAL FREQUENCY LIST

**Bill Laver**  
Covering the services and transmission modes that can be heard on the bands between 1.635 and 29.7MHz. £8.95

#### VHF/UHF AIRBAND FREQUENCY GUIDE (Updated)

A complete guide to the airband frequencies including how to receive the signals, the frequencies and services, VOLMET and much more about the interesting subject of airband radio. 74 pages. £5.95

#### WORLD RADIO TV HANDBOOK 1990

Country-by-country listings of long, medium and short wave broadcast and TV stations. Receiver test reports. English language broadcasts. The s.w.l.'s "bible". 578 pages. £19.99

### INTERFERENCE

#### INTERFERENCE HANDBOOK (USA)

**William R. Nelson WA6FDG**  
How to locate and cure r.f.i. for radio amateurs, CBers and TV and stereo owners. 253 pages. £6.75

#### RADIO FREQUENCY INTERFERENCE (USA)

What causes r.f.i.? Are all r.f.i. problems difficult, expensive and time-consuming to cure? These questions and many more are answered in this book. 84 pages. £4.30

### AMATEUR RADIO

#### AMATEUR RADIO CALL BOOK (RS6B)

**1990 Edition**  
Now incorporates a 48-page section of useful information for amateur radio enthusiasts. 310 pages. £7.70

#### AMATEUR RADIO SATELLITES the first 25 years

**Arthur C. Gee G2UK**  
This souvenir publication mainly a pictorial account of the pattern of developments which have occurred over the last 25 years. 34 pages. £2.25

#### AN INTRODUCTION TO AMATEUR RADIO (BP257)

**I. D. Poole**  
This book gives the newcomer a comprehensive and easy to understand guide through amateur radio. Topics include operating procedures, jargon, propagation and setting up a station. 150 pages. £3.50

#### HINTS AND KINKS FOR THE RADIO AMATEUR

**Edited by Charles L. Hutchinson and David Newkirk**  
A collection of practical ideas gleaned from the pages of QST magazine. 152 pages. £4.95





Podule

Greyscale Card

The makers of the award winning **WEATHER SATELLITE STATION** For Archimedes and Atari present ...

**!Orrey** £95.00

**spacetech** Tel: 0305 822753  
 Fax: 0305 860453  
 Space Science Resources  
 21 West Woods, Portland, Dorset, DT5 2EA

**NEW**

**FAX and WEATHER SATELLITES**

Full resolution charts and greyscale pictures from any SPECTRUM computer to a dot matrix printer. Basic system £40 plus interface for FAX £40 or WX SATS £59.

**APT-1 WEATHER SATELLITE MODULE**

Enables all weather satellite signals to be displayed on any FAX system. Plugs into RX-8 system direct. £59 or £39 if ordered with RX-8.

**RX- 8 8 - MODE RECEIVE**

Every possible feature and performance to receive FAX, HF & VHF PACKET, COLOUR SSTV, RTTY, CW, AMTOR, UoSAT and ASCII on any BBC computer. Reviews Oct. 89 Ham Radio Today and March 90 Amateur Radio. Complete system of EPROM, interface, instructions, leads and demo cassette £259.

**RX-4 RTTY CW SSTV AMTOR RECEIVE**

Performance, features and ease of use make this still a best-seller. Needs TIF1 interface. **BBC, CBM64** tape £25, disk £27. **VIC20** tape £25. **SPECTRUM** tape £40, + 3 disk £42 inc adapter board (needs TIF1 also) or software-only version £25. **TIF 1 INTERFACE** has 4-pole filtering and computer noise isolation for excellent HF and VHF performance. Kit £25, ready-made, boxed with all connections £40. Available only with software.

Also **MORSE TUTOR** £6, **LOGBOOK** £8, **RAE MATHS** £9 for **BBC, CBM64, VIC20** and **SPECTRUM**. **BBC LOCATOR** with UK, Europe, World maps £10. Disk £2 extra for all.

Lots of information available about everything, please ask. Prices include VAT and p&p by return.

 **technical software** (SWM) 

Fron, Upper Llandwrog, Caernarfon LL54 7RF  
 Tel: 0286 881886

**PLEASE MENTION SHORT WAVE MAGAZINE WHEN REPLYING TO ADVERTISEMENTS.**

**IF YOU ARE INTERESTED IN ADVERTISING IN SWM, PLEASE CALL ROGER HALL, OUR AD. MANAGER ON 071-731 6222 OR MARCIA BROGAN IN OUR PRODUCTION DEPARTMENT IN POOLE ON (0202) 676033**

**PRACTICAL WIRELESS**

**PW**

**INTERESTED IN TRANSMITTING AS WELL AS RECEIVING?**

**THEN READ PRACTICAL WIRELESS EVERY MONTH... AT YOUR NEWSAGENT NOW!**

**Camden BOOKS**

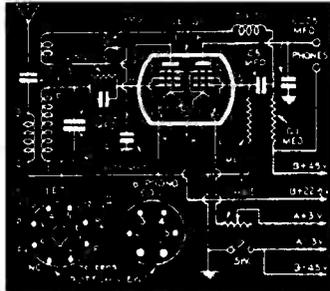

**GREAT SHORTWAVE RADIO BOOK REPRINTS**

Here at "Camden" we pride ourselves on not only offering great value books, but also being able to comment knowledgeably on their contents. Truth to tell, this doesn't happen with our Shortwave Radio books, because we cannot find the time to read them and learn up about the subject, but we do know that they are GREAT!

We make this statement with absolute certainty because they are all reprinted by a lunatic called Tom Lindsay who is (a) a genius at selecting the right book to reprint and (b) is a committed Shortwave Radio man.

All his reprints date from the golden, valved, years of Radio - mainly from the 1930s, but one from 1911 and some from the 40s. They vary in format, but all are high quality, very reasonably priced, paperbacks and as a reader of "Short Wave Magazine" we KNOW you will find them unique and very, very interesting.

For full Details of Lindsay's range of radio and other books, plus loads of other titles, mainly on model engineering, engineering and transportation subjects, send a large SAE (32p stamp for UK or 4 International Reply Coupons for overseas airmail) for a copy of our NEW 40 page Booklist - you won't be disappointed.

SEND (NO STAMP REQUIRED IN UK) TO:

**CAMDEN MINIATURE STEAM SERVICES**  
 FREEPOST, 13 HIGH STREET, Rode, Bath BA3 6UB  
 Tel: (0373) 830151

 (CALLERS WELCOME BY PRIOR APPOINTMENT) 

## HOW TO PASS THE RADIO AMATEURS' EXAMINATION (RSGB)

Clive Smith G4FZH and George Benbow G3HB

The background to multiple choice exams and how to study for them with sample RAE papers for practice plus maths revision. 88 pages. £6.20

## PASSPORT TO AMATEUR RADIO

Reprinted from PW 1981-1982

The famous series by GW3JGA, used by thousands of successful RAE candidates in their studies. Plus other useful articles for RAE students. 96 pages. £1.50

## PRACTICAL GUIDE TO PACKET OPERATION IN THE UK

Mike Mansfield G6AWD

Introduces the concept of packet radio to the beginner. Problem areas are discussed and suggestions made for solutions to minimise the problems. Deals with the technical aspects of packet taking the reader through setting up and provides a comprehensive guide to essential reference material. 68 pages. £6.00

## PRACTICAL IDEAS FOR RADIO AMATEURS

Ian Poole G3YWX

Offers a wealth of hints, tips and general practical advice for all transmitting amateurs and short wave listeners. 128 pages. £5.95

## RADIO AMATEUR'S GUIDE TO RADIO WAVE PROPAGATION

(HF Bands), F. C. Judd G2BCX

The how and why of the mechanism and variations of propagation in the h.f. bands. 144 pages. £8.95

## THE 1990 ARRL HANDBOOK FOR THE RADIO AMATEUR

This is the 66th edition of this very useful hardback reference book. Updated throughout it has several new sections covering oscilloscopes, spectrum analysers, digital frequency synthesis, phase-noise measurement and new constructional projects. 1200 pages. £15.95

## \*THE ARRL OPERATING MANUAL

Another very useful book from the ARRL. Although written for the American radio amateur, this book will also be of use and interest to the UK amateur. 684 pages. £12.95

## THE ARRL SATELLITE ANTHOLOGY

The best from the Amateur Satellite News column and articles out of 31 issues of QST have been gathered together in this book. The latest information on OSCARs 9 through 13 as well as the RS satellites is included. Operation on Phase 3 satellites (OSCAR 10 and 13) is covered in detail. 97 pages. £4.95

## THE COMPLETE DX'er

Bob Locher W9KNI

Now back in print, this book covers equipment and operating techniques for the DX chaser, from beginner to advanced. 187 pages. £7.95

## THE RAE MANUAL (RSGB)

G.L. Benbow G3HB

The latest edition of the standard aid to studying for the Radio Amateurs' Examination. Updated to cover the latest revisions to the syllabus. 132 pages. £6.20

## THE RADIO AMATEUR'S DX GUIDE (USA)

15th Edition

The guide contains information not easily obtained elsewhere and is intended as an aid and quick reference for all radio amateurs interested in DX. 38 pages. £2.95

## THE RADIO AMATEUR'S QUESTIONS & ANSWER REFERENCE MANUAL

4th Edition, R. E. G. Petri G8CCJ

This book has been compiled especially for students of the City and Guilds of London Institute RAE. It is structured with carefully selected multiple choice questions, to progress with any recognised course of instruction, although it is not intended as a text book. 280 pages. £7.95

## VHF HANDBOOK FOR RADIO AMATEURS (USA)

H. S. Brier W9EGQ & W. I. Orr W6SAI

VHF/UHF propagation, including moonbounce and satellites, equipment and antennas. 335 pages. £7.95

## YOUR GATEWAY TO PACKET RADIO

Stan Horzepa W4ILOU

What is packet radio good for and what uses does it have for the 'average' amateur? What are protocols? Where, why, when? Lots of the most asked questions are answered in this useful book. It included details of networking and space communications using packet. 278 pages. £7.95

## MAPS

### IARU LOCATOR MAP OF EUROPE

DARC

This multi-coloured, plastics laminated, map of Europe shows the AIRU (" Maidenhead") Locator System. Indispensable for the v.h.f. and u.h.f. DXer. 692 x 872mm. £5.25

### RADIO AMATEUR'S MAP OF NORTH AMERICA (USA)

Shows radio amateur prefix boundaries, continental boundaries and zone boundaries. 760 x 636mm. £2.95

### RADIO AMATEUR'S PREFIX MAP OF THE WORLD (USA)

Showing prefixes and countries, plus listings by order of country and of prefix. 1014 x 711mm. £2.95

### RADIO AMATEUR'S WORLD ATLAS (USA)

Seventeen pages of maps, including the world-polar projection. Also includes the table of allocation of international call sign series. £3.50

## DATA REFERENCE

### DIGITAL IC EQUIVALENTS AND PIN CONNECTIONS (BP140)

A. Michaels

Equivalents and pin connections of a popular selection of European, American and Japanese digital i.c.s. 256 pages. £5.95.

### INTERNATIONAL DIODE EQUIVALENTS GUIDE (BP108)

A. Michaels

Possible substitutes for a large selection of many different types of semiconductor diodes. 144 pages. 0/P.

### INTERNATIONAL TRANSISTOR EQUIVALENTS GUIDE (BP85)

A. Michaels

Possible substitutes for a popular selection of European, American and Japanese transistors. 320 pages. £3.50

### LINEAR IC EQUIVALENTS AND PIN CONNECTIONS (BP141)

A. Michaels

Equivalents and pin connections of a popular selection of European, American and Japanese linear i.c.s. 320 pages. 0/P

### NEWNES AUDIO & HI-FI ENGINEER'S POCKET BOOK

Vivian Capele

This is a concise collection of practical and relevant data for anyone working on sound systems. The topics covered include microphones, gramophones, CDs to name a few. 190 pages. Hardback. £9.95

### NEWNES COMPUTER ENGINEER'S POCKET BOOK

This is an invaluable compendium of facts, figures, circuits and data and is indispensable to the designer, student, service engineer and all those interested in computer and microprocessor systems. 203 pages. Hardback. £9.95

## NEWNES ELECTRONICS POCKET BOOK

5th Edition

Presenting all aspects of electronics in a readable and largely non-mathematical form for both the enthusiast and the professional engineer.

315 pages. Hardback. £8.95

## NEWNES RADIO AND ELECTRONICS ENGINEER'S POCKET BOOK

18th Edition, Keith Brindley

Useful data covering math, abbreviations, codes, symbols, frequency bands/allocations, UK broadcasting stations, semi-conductors, components, etc. 325 pages. Hardback. £9.95

## POWER SELECTOR GUIDE (BP235)

J. C. J. Van de Ven

This guide has the information on all kinds of power devices in useful categories (other than the usual alpha numeric sort) such as voltage and power properties making selection of replacements easier. 180 pages. £4.95

## FAULT FINDING

### ARE THE VOLTAGES CORRECT?

Reprinted from PW 1982-1983

How to use a multimeter to fault-find on electronic and radio equipment, from simple resistive dividers through circuits using diodes, transistors, i.c.s and valves. 44 pages. £1.50

### GETTING THE MOST FROM YOUR MULTIMETER (BP239)

R. A. Penfold

This book is primarily aimed at beginners. It covers both analogue and digital multimeters and their respective limitations. All kinds of testing is explained too. No previous knowledge is required or assumed. 102 pages. £2.95

### MORE ADVANCED USES OF THE MULTIMETER (BP265)

R. A. Penfold

This book is primarily intended as a follow-up to BP239. Getting the most from your Multimeter. By using the techniques described in this book you can test and analyse the performance of a range of components with just a multimeter (plus a very few inexpensive components in some cases). The simple add-ons described extend the capabilities of a multimeter to make it even more useful. 85 pages. £2.95.

### OSCILLOSCOPES, HOW TO USE THEM, HOW THEY WORK

3rd Edition Ian Hickman

This book describes oscilloscopes ranging from basic to advanced models and the accessories to go with them. £12.95

### PRACTICAL HANDBOOK OF VALVE RADIO REPAIR

Chas E. Miller

The definite work on repairing and restoring valued broadcast receivers dating from the 1930s to the 60s. Appendices giving intermediate frequencies, valve characteristic data and base connections. 230 pages. Hardback. £20.00

### TRANSISTOR RADIO FAULT FINDING CHART (BP70)

C. E. Miller

Used properly, should enable most common faults to be traced reasonably quickly. Selecting the appropriate fault description at the head of the chart, the reader is led through a sequence of suggested checks until the fault is cleared. 635 x 455mm (approx). £0.95

## CONSTRUCTION

### HOW TO DESIGN AND MAKE YOUR OWN P.C.B.s (BP121)

R. A. Penfold

Designing or copying printed circuit board designs from magazines, including photographic methods. 80 pages. £0.50

### INTRODUCING QRP

Collected articles from PW 1983-1985

An introduction to low-power transmission (QRP). This book includes full constructional details of a variety of designs by Rev. George Dobbs G3RLV for transmitters and transceivers covering Top Band to 14MHz, together with test equipment by Tony Smith G4FAL. 64 pages. £1.50

### MORE ADVANCED POWER SUPPLY PROJECTS (BP192)

R. A. Penfold

The practical and theoretical aspects of the circuits are covered in some detail. Topics include switched mode power supplies, precision regulators, dual tracking regulators and computer controlled power supplies, etc. 92 pages. £2.95

### POWER SUPPLY PROJECTS (BP76)

R. A. Penfold

This book gives a number of power supply designs including simple unswitched types, fixed voltage regulated types and variable voltage stabilised designs. 91 pages. £2.50

### PRACTICAL POWER SUPPLIES

Collected articles from PW 1978-1985

Characteristics of batteries, transformers, rectifiers, fuses and heatsinks, plus designs for a variety of mains/iven power supplies, including the P.W. "Marchwood" giving a fully stabilised and protected 12V 30A d.c. 48 pages. £1.25

### QRP NOTEBOOK

Doug DeMaw W1FB

This book deals with the building and operating of a successful QRP station. Lots of advice is given by the author who has spent years as an ardent QRP'er. All the text is easy-to-read and the drawings large and clear. 77 pages. £4.95

### TEST EQUIPMENT CONSTRUCTION (BP248)

R. A. Penfold

Describes, in detail, how to construct some simple and inexpensive, but extremely useful, pieces of test equipment. 104 pages. £2.95

### 50 (FET) FIELD EFFECT TRANSISTOR PROJECTS (BP39)

F. G. Rayer

50 circuits for the s.w.l., radio amateur, experimenter or audio enthusiast using f.e.t.s. 104 pages. £2.95

## ANTENNAS (AERIALS)

### AERIAL PROJECTS (BP105)

Practical designs including active, loop and ferrite antennas plus accessory units. 96 pages. £2.50

### ALL ABOUT CUBICAL QUAD ANTENNAS (USA)

W. I. Orr W6SAI & S. D. Cowan W2LX

Theory, design, construction, adjustment and operation of quads. Quads vs. Yagis. Gain figures. 109 pages. £5.50

### ALL ABOUT VERTICAL ANTENNAS (USA)

W. I. Orr W6SAI & S. D. Cowan W2LX

Theory, design, construction, operation, the secrets of making vertical work. 191 pages. £7.50

### AN INTRODUCTION TO ANTENNA THEORY (BP198)

H. C. Wright

This book deals with the basic concepts relevant to receiving and transmitting antennas. Lots of diagrams reduce the amount of mathematics involved. 86 pages. £2.95

## ANTENNA IMPEDANCE MATCHING

Wilfred N. Caron

Proper impedance matching of an antenna to a transmission line is of concern to antenna engineers and to every radio amateur. A properly matched antenna as the termination for a line minimises feed-line losses. Power can be fed to such a line without the need for a matching network at the line input. There is no mystique involved in designing even the most complex multi-element networks for broadband coverage. Logical step-by-step procedure is followed in this book to help the radio amateur with this task. 192 pages. £11.95

## BEAM ANTENNA HANDBOOK (USA)

W. I. Orr W6SAI & S. D. Cowan W2LX

Design, construction, adjustment and installation of h.f. beam antennas. 198 pages. £6.75

## \*NOVICE ANTENNA NOTEBOOK

Doug DeMaw W1FB

Another book from the pen of W1FB, this time offering "new ideas for beginning hams". All the drawings are large and clear and each chapter ends with a glossary of terms. 130 pages. £5.95

## OUT OF THIN AIR

Collected Antenna Articles from PW 1977-1980

Including such favourites as the ZL Special and 2BCX 16-element beams for 2m, and the famous "Slim Jim", designed by Fred Judd G2BCX. Also features systems for Top Band, medium wave/long wave loop designs and a v.h.f. direction finding loop. Plus items on propagation, accessories and antenna design. 80 pages. £1.80

## PRACTICAL WIRE ANTENNAS - Effective HF Designs for the Radio Amateur

John D. Hays G3BCO

Wire antennas offer one of the most cost-effective ways to put out a good signal on the h.f. bands and this practical guide to their construction has something to interest every amateur on a budget. 100 pages. £7.53.

## SIMPLE, LOW-COST WIRE ANTENNAS FOR RADIO AMATEURS (USA)

W. I. Orr W6SAI & S. D. Cowan W2LX

Efficient antennas for Top Band to 2m, including "invisible" antennas for difficult station locations. 191 pages. £6.75

## THE ARRL ANTENNA BOOK (USA) 15th Edition

A station is only as effective as its antenna system. This book covers propagation, practical constructional details of almost every type of antenna, test equipment and formulas and programs for beam heading calculations. £12.95

## THE ARRL ANTENNA COMPENDIUM (USA)

Volume One

Fascinating and hitherto unpublished material. Among the topics discussed are quads and loops, loop periodic arrays, beam and multi-band antennas, verticals and reduced size antennas. 175 pages. £7.50

## WIRES & WAVES

Collected Antenna Articles from PW 1980-1984

Antenna and propagation theory including NBS Yagi design data. Practical designs for antennas from medium waves to microwaves, plus accessories such as a t.u.s.w.r. and power meters and a noise bridge. Dealing with TVI. 180 pages. £3.00

## W1FB'S ANTENNA NOTEBOOK

Doug DeMaw W1FB

This book provides lots of designs, in simple and easy to read terms, for simple wire and tubing antennas. All drawings are large and clear making construction much easier. 124 pages. £5.95

## 25 SIMPLE AMATEUR BAND AERIALS (BP125)

E. M. Noll

How to build 25 simple and inexpensive aerials, from a simple dipole through beam and triangle designs to a mini-rhombic. Dimensions for specific spot frequencies including the WARC bands. 80 pages. £1.95

## 25 SIMPLE INDOOR AND WINDOW AERIALS (BP136)

E. M. Noll

Designs for people who live in flats or have no gardens, etc., giving surprisingly good results considering their limited dimensions. 64 pages. £1.75

## 25 SIMPLE SHORT WAVE BROADCAST BAND AERIALS (BP132)

E. M. Noll

Designs for 25 different aerials, from a simple dipole through helical designs to a multi-band umbrella. 80 pages. £1.95

## 25 SIMPLE TROPICAL AND MW BAND AERIALS (BP145)

E. M. Noll

Simple and inexpensive aerials for the broadcast bands from medium wave to 49m. 64 pages. £1.75

## THE RADIO AMATEUR ANTENNA HANDBOOK

William I. Orr W6SAI & Stuart D. Cowan W2LX

Yagi, quad, quagi, l-p, vertical, horizontal and "sloper" antennas are all covered. Also towers, grounds and rotators. 190 pages. £6.75

## COMPUTING

### AN INTRODUCTION TO COMPUTER COMMUNICATIONS (BP177)

R. A. Penfold

Details of various types of modem and their applications, plus how to interconnect computers, modems and the telephone system. Also networking systems and RTTY. 96 pages. £2.95

### AN INTRODUCTION TO COMPUTER PERIPHERALS (BP170)

J. W. Penfold

Covers a wide range of computer peripherals such as monitors, printers, disk drives, cassette recorders, modems, etc., explaining what they are, how to use them and the various types of standards. 80 pages. £2.50

### MICROPROCESSING SYSTEMS AND CIRCUITS (BP77)

Elements of Electronics Book 4

F. A. Wilson

A comprehensive guide to the elements of microprocessing systems, which are becoming ever more involved in radio systems and equipment. 236 pages. 0/P

### NEWNES AMATEUR RADIO COMPUTING HANDBOOK

Joe Pritchard G1UOW

Shows how radio amateurs and short wave listeners can "listen" to signals by reading text on a computer screen. This book also covers the application of computers to radio "housekeeping" jobs such as log-keeping, QSL cards, satellite predictions and antenna design as well as showing how to control a radio with the computer. 368pages. £14.95

## MORSE

### INTRODUCING MORSE

Collected Articles from PW 1982-1985

Ways of learning the Morse Code, followed by constructional details of a variety of keys including lambic, Triambic, and an Electronic Bug with a 528-bit memory. 48 pages. £1.25

### THE SECRET OF LEARNING MORSE CODE

Mark Francis

Designed to make you proficient in Morse code in the shortest possible time, this book points out many of the pitfalls that beset the student. 87 pages. £4.95

# ICOM

**ICOM are proud to introduce the IC-R72 Communications Base Receiver to complement the IC-R100 Mobile and IC-R1 Handheld receivers giving the enthusiastic listener a full choice.**



## Features:

- **Direct Frequency entry**
- **99 Memory Channels**
- **Built-in clock and timer**
- **AC/DC operation**
- **Noise Blanker**
- **Pre-amp and Attenuator**
- **ICOM's DDS system (direct digital synthesiser)**

## IC-R72 Communications Receiver

ICOM's communication receivers have a reputation for reliability and quality. Building on this reputation the IC-R72 HF receiver is one of a new line of wideband receivers to satisfy listeners everywhere.

This compact receiver has continuous coverage from 100kHz—30MHz, in SSB, AM and CW modes. An optional UI-8 adds FM reception. The easy to operate IC-R72 is superb for beginners or experienced DX'ers alike and is equipped with a variety of functions. The IC-R72 joins ICOM's current line of quality receivers. For a free brochure on this or any other ICOM Amateur Radio product contact your local authorised ICOM dealer or ICOM (UK) Ltd.

## Icom (UK) Ltd

Dept. SW, Sea Street, Herne Bay, Kent CT6 8LD. Tel: 0227 741741. Fax: 0227 360155.

**Visa & Mastercards:** Telephone orders taken by mail order, instant credit & interest-free HP. Despatch on same day whenever possible.



